

# Table of Contents

<b>1A. Introduction</b>	11
Step 1 - Guide Info	12
Step 2 - How to navigate through the manual	12
Step 3 - View high resolution images	13
Step 4 - Compatibility	13
Step 5 - Important: Electronics protection	14
Step 6 - Labels guide	15
Step 7 - Spare bag	15
Step 8 - We are here for you!	16
Step 9 - Pro tip: inserting the nuts	17
Step 10 - Bearing Lubrication Pacifier	18
Step 11 - Prepare your desk	18
<b>1B. MK4S Inspection</b>	19
Step 1 - Introduction	20
Step 2 - Firmware Update	20
Step 3 - Printer Preparation 2	21
Step 4 - Printer Preparation 2	21
Step 5 - Printer Preparation 3	22
Step 6 - Heatbed Inspection	22
Step 7 - Y-Rods Inspection	23
Step 8 - Haribo?	23
Step 9 - Get Started	24
<b>1C. Printer Disassembly</b>	25
Step 1 - Tools Required	26
Step 2 - Electronics Disassembly	26
Step 3 - Wi-Fi Disassembly	27
Step 4 - Cable Bundle Disassembly	27
Step 5 - Cables Disconnecting 1	28
Step 6 - Cables Disconnecting 2	28
Step 7 - Cable Budle Release	29
Step 8 - xLCD Removal	29
Step 9 - Y Idler Removal	30
Step 10 - Idler Pulley Removal	30
Step 11 - Y Motor Removal	31
Step 12 - Power Panic Cable Removal	31
Step 13 - Power Cable Removal	32
Step 14 - PSU Removal 1	32
Step 15 - PSU Removal 2	33
Step 16 - Heatbed Removal	33
Step 17 - Y-Axis Removal	34
Step 18 - Y-Axis Disassembly	34
Step 19 - Bearings Removal	35
Step 20 - Expansion Joint Removal	35
Step 21 - Extruder Cover Removal	35
Step 22 - Hotend Assembly Removal	36
Step 23 - Print Fan Removal	36
Step 24 - Heatsink Fan Removal	37
Step 25 - Nextruder Removal	37
Step 26 - LoveBoard Removal	38
Step 27 - Z Motors Removal	38

Step 28 - Z Motors Removal 2 .....	39
Step 29 - Z Motors Removal 3 .....	39
Step 30 - Z Rods Removal .....	40
Step 31 - Trapeze Nut Removal .....	40
Step 32 - X Motor Release .....	41
Step 33 - X Belt Release .....	41
Step 34 - X Motor Removal .....	42
Step 35 - X Idler Shaft Removal .....	42
Step 36 - X Idler Removal .....	43
Step 37 - xBuddy Removal .....	43
<b>1D. Component Prep .....</b>	<b>44</b>
Step 1 - xBuddy Prep .....	45
Step 2 - xLCD Disassembly .....	45
Step 3 - xLCD Disassembly 2 .....	46
Step 4 - Print Fan Prep .....	46
Step 5 - Y Motor Prep .....	47
Step 6 - Y Motor Prep 2 .....	47
Step 7 - X Motor Prep .....	48
Step 8 - Z Motor Prep .....	48
Step 9 - Heatbed Prep .....	49
Step 10 - Heatbed Prep 2 .....	49
Step 11 - Thermistor Prep .....	50
Step 12 - Thermistor Installation .....	50
Step 13 - Thermistor Installation 2 .....	51
Step 14 - Thermistor Installation 3 .....	51
Step 15 - Heatbed Rework .....	52
Step 16 - Gearbox Cover Preparation .....	52
Step 17 - Nextruder Rework .....	53
Step 18 - Nextruder Rework 2 .....	53
Step 19 - Bearings Check .....	54
Step 20 - Parts Check .....	54
Step 21 - Parts Recap 1 .....	55
Step 22 - Parts Recap 2 .....	55
Step 23 - Parts Recap 3 .....	56
Step 24 - Parts Recap 4 .....	56
Step 25 - Parts Recap 5 .....	57
Step 26 - Parts Recap 6 .....	57
<b>2. Base assembly .....</b>	<b>58</b>
Step 1 - Tools necessary for this chapter .....	59
Step 2 - Base assembly: parts preparation .....	59
Step 3 - Inserting the zip ties .....	60
Step 4 - Base assembly: parts preparation (Part 1) .....	60
Step 5 - Base assembly: parts preparation (Part 2) .....	61
Step 6 - Installing the motor mounts .....	61
Step 7 - Installing the rear motor .....	62
Step 8 - Securing the rear motor .....	62
Step 9 - Installing the front motor right .....	63
Step 10 - Installing the front motor left .....	63
Step 11 - Bottom frame: parts preparation .....	64
Step 12 - Assembling the bottom profile: front + left .....	64
Step 13 - Assembling the bottom profile: left + rear .....	65
Step 14 - Assembling the bottom profile: right .....	65
Step 15 - Inserting the spacer pins .....	66
Step 16 - Anti-vibration feet: parts preparation .....	66

Step 17 - Installing the anti-vibration feet .....	67
Step 18 - Installing the bottom frame .....	68
Step 19 - Mounting the bottom frame: right side .....	68
Step 20 - Mounting the bottom frame: rear + left + front .....	69
Step 21 - Haribo time .....	69
Step 22 - Done .....	70
<b>3. Back assembly .....</b>	<b>71</b>
Step 1 - Tools necessary for this chapter .....	72
Step 2 - xBuddy: parts preparation I. ....	72
Step 3 - xBuddy: parts preparation II. ....	73
Step 4 - Applying the thermal pads .....	73
Step 5 - Installing the xBuddy .....	74
Step 6 - Installing the xBuddy extension .....	74
Step 7 - Installing zip ties .....	75
Step 8 - Connecting the xBuddy extension board .....	75
Step 9 - Inserting grommets: xBuddy box .....	76
Step 10 - Wi-Fi: parts preparation .....	76
Step 11 - Assembling the Wi-Fi .....	77
Step 12 - Installing the Wi-Fi assembly .....	77
Step 13 - PSU assembly: parts preparation .....	78
Step 14 - Preparing the PSU .....	78
Step 15 - Power cables info .....	79
Step 16 - Connecting the PSU .....	80
Step 17 - Back panel: parts preparation .....	80
Step 18 - Installing grommets: back panel top .....	81
Step 19 - Installing grommets: sides .....	81
Step 20 - Aligning the PSU .....	82
Step 21 - Mounting the PSU .....	82
Step 22 - Aligning the xBuddy box assembly .....	83
Step 23 - Mounting the xBuddy box .....	83
Step 24 - PSU-cable-cover: parts preparation .....	84
Step 25 - Preparing the PSU-cable-cover .....	84
Step 26 - PSU-cable-cover installation .....	85
Step 27 - Chamber fans: parts preparation .....	85
Step 28 - New fan cover - visual reference .....	86
Step 29 - Assembling the fan grid .....	87
Step 30 - Attaching the fans .....	87
Step 31 - Covering the cooling fans .....	88
Step 32 - Rear profiles: parts preparation .....	88
Step 33 - Installing the rear profiles .....	89
Step 34 - Mounting the back panel .....	89
Step 35 - Securing the Back panel .....	90
Step 36 - Power Terminal Screws Preparation .....	90
Step 37 - Connecting the power cables .....	91
Step 38 - Stepper splitter: parts preparation .....	91
Step 39 - Guiding the Stepper splitter cable .....	92
Step 40 - Connecting the Stepper splitter .....	92
Step 41 - Mounting the Stepper Splitter .....	93
Step 42 - LCD cable: parts preparation .....	93
Step 43 - Guiding the LCD cable .....	94
Step 44 - Main FE cable INFO .....	94
Step 45 - Connecting the FE cable (no 3.) .....	95
Step 46 - Guiding the FE cable (no. 2) .....	95
Step 47 - Guiding the FE cable (no. 1) .....	96

Step 48 - Guiding the FE cable (no. 4 and 5) .....	96
Step 49 - Cable Bundle Cleanup .....	97
Step 50 - FE cable - xBuddy: parts preparation .....	97
Step 51 - Connecting the FE cable: xBuddy .....	98
Step 52 - Plugging the xLCD cable .....	98
Step 53 - PSU-cover: parts preparation .....	99
Step 54 - Connecting the FE cable: PSU .....	99
Step 55 - Haribo time .....	100
Step 56 - Done .....	100
<b>4. Heatbed assembly .....</b>	<b>101</b>
Step 1 - Tools necessary for this chapter .....	102
Step 2 - Heatbed: parts preparation .....	103
Step 3 - Heatbed Cable Assembly 1 .....	103
Step 4 - Heatbed Cable Assembly 2 .....	104
Step 5 - Bed-cable-cover-bottom: parts preparation .....	104
Step 6 - Attaching the cable cover .....	105
Step 7 - Heatbed carriage: parts preparation .....	105
Step 8 - Preparing the heatbed carriage .....	106
Step 9 - Installing the expansion joints .....	106
Step 10 - RGB LED strip: parts preparation .....	107
Step 11 - Installing the LED strip .....	107
Step 12 - Attaching the LED strip diffuser .....	108
Step 13 - Covering the RGB LED strip .....	108
Step 14 - Guiding the RGB LED strip cable .....	109
Step 15 - Bearing Lubrication Preparation .....	109
Step 16 - Bearing Lubrication .....	110
Step 17 - Bed mounts: parts preparation .....	110
Step 18 - Assembling the bed mounts .....	111
Step 19 - Securing the bed mounts .....	111
Step 20 - Bed mounts: inserting the nuts .....	112
Step 21 - Assembling the CORE-One-bed-spacer-rear .....	112
Step 22 - Installing the bed-mount-right .....	112
Step 23 - Installing the bed-mount-left .....	113
Step 24 - Mounting the heatbed: parts preparation .....	113
Step 25 - Mounting the heatbed .....	114
Step 26 - Tightening the heatbed .....	114
Step 27 - Covering the cables: parts preparation .....	115
Step 28 - Guiding the heatbed cables .....	115
Step 29 - Covering the heatbed cables .....	116
Step 30 - Mounting the heatbed: parts preparation .....	116
Step 31 - Attaching the heatbed assembly .....	117
Step 32 - Mounting the heatbed assembly: rear motor .....	118
Step 33 - Mounting the heatbed assembly: front motor left .....	118
Step 34 - Mounting the heatbed assembly: front motor right .....	119
Step 35 - Attaching the heatbed cables I. ....	119
Step 36 - Attaching the heatbed cables II. ....	120
Step 37 - Securing the heatbed cables: parts preparation .....	120
Step 38 - Securing the textile sleeve .....	121
Step 39 - Guiding the heatbed assembly cables .....	121
Step 40 - Connecting the heatbed power cables .....	122
Step 41 - Haribo time .....	122
<b>5. CoreXY assembly .....</b>	<b>123</b>
Step 1 - Tools necessary for this chapter .....	124
Step 2 - Rod holders: parts preparation .....	124

Step 3 - Assembling the rod holders .....	125
Step 4 - Preparing the front rod holders .....	125
Step 5 - Installing the front rod holders .....	126
Step 6 - XY carriage: parts preparation .....	126
Step 7 - Assembling the XY-carriages .....	127
Step 8 - Assembling the linear holder left .....	127
Step 9 - Assembling the linear holder right .....	128
Step 10 - Attaching the linear holder assemblies .....	128
Step 11 - Smooth rods INFO .....	129
Step 12 - Mounting the smooth rods .....	129
Step 13 - Securing the rear rod holders .....	130
Step 14 - Securing the front rod holders .....	130
Step 15 - Motor mounts: parts preparation .....	131
Step 16 - Motor mounts: part preparation .....	131
Step 17 - Assembling the XY-motor-mount-right I. ....	132
Step 18 - Assembling the XY-motor-mount-right II. ....	132
Step 19 - Assembling the XY-motor-mount-left I. ....	133
Step 20 - Assembling the XY-motor-mount-left II. ....	133
Step 21 - Belt tensioners: parts preparation I. ....	134
Step 22 - Belt tensioners: parts preparation II. ....	134
Step 23 - Preparing the tensioner pulleys .....	135
Step 24 - Assembling the belt tensioner left I. ....	135
Step 25 - Assembling the belt tensioner left II. ....	136
Step 26 - Assembling the belt tensioner right .....	136
Step 27 - Installing the belt tensioners: parts preparation .....	137
Step 28 - Installing the motor mount left .....	137
Step 29 - Installing the motor mount right .....	138
Step 30 - Installing the belt-tensioner-left .....	138
Step 31 - Installing the belt-tensioner-right .....	139
Step 32 - Linear rail: parts preparation .....	139
Step 33 - Attaching the linear rail .....	140
Step 34 - Securing the linear rail .....	140
Step 35 - Installing the linear rail: parts preparation .....	141
Step 36 - Installing the linear rail assembly .....	141
Step 37 - Linear rail: removing the safety pins .....	142
Step 38 - Bed-stop: parts preparation .....	142
Step 39 - Assembling the bed-stop .....	142
Step 40 - Mounting the bed-stop .....	143
Step 41 - X&Y motors: parts preparation .....	143
Step 42 - Installing the X-axis pulley .....	144
Step 43 - Installing the Y-axis pulley .....	145
Step 44 - XY belts: parts preparation .....	146
Step 45 - XY belts INFO .....	146
Step 46 - Y belt guiding: Y motor pulley .....	147
Step 47 - Securing the Y-axis motor .....	147
Step 48 - Y belt guiding: Y motor mount .....	148
Step 49 - Y belt guiding: belt tensioner .....	148
Step 50 - Y belt guiding: X motor mount .....	149
Step 51 - Y belt guiding: securing the belt .....	149
Step 52 - X belt guiding: X motor pulley .....	150
Step 53 - Securing the X-axis motor .....	150
Step 54 - Y belt guiding: X motor mount .....	151
Step 55 - X belt guiding: belt tensioner .....	151
Step 56 - X belt guiding: Y motor mount .....	152
Step 57 - X belt guiding: securing the belt .....	152

Step 58 - Checking the belt guidance .....	153
Step 59 - Bowden guide: parts preparation .....	153
Step 60 - Securing the Nextruder holder .....	154
Step 61 - Securing the Y motor cable .....	154
Step 62 - Securing the X motor cable .....	155
Step 63 - Installing the bowden guide .....	155
Step 64 - White LED strip: parts preparation .....	156
Step 65 - Sticking the White LED strip .....	156
Step 66 - Installing the white LED assembly .....	157
Step 67 - Door sensor & White LED strip: parts preparation .....	157
Step 68 - Inserting the zip ties .....	158
Step 69 - Installing the door sensor .....	158
Step 70 - Securing the door sensor cable .....	159
Step 71 - Guiding the cables: LED and door sensor .....	159
Step 72 - Smooth rods: parts preparation .....	160
Step 73 - Installing the CoreXY assembly .....	160
Step 74 - Securing the smooth rods .....	161
Step 75 - Aligning the linear rail .....	161
Step 76 - Guiding the corexy cables .....	162
Step 77 - Guiding the cooling fan cables .....	162
Step 78 - Fixing the bed-stop .....	163
Step 79 - Connecting the cooling fans cables .....	163
Step 80 - Connecting the corexy cables .....	164
Step 81 - Haribo time .....	164
Step 82 - Done .....	165
<b>6. Nextruder assembly .....</b>	<b>166</b>
Step 1 - Tool necessary for this chapter .....	167
Step 2 - Mounting the Nextruder: parts preparation .....	167
Step 3 - Protecting the heatbed .....	168
Step 4 - Mounting the Nextruder .....	168
Step 5 - Hotend fan: parts preparation .....	169
Step 6 - Installing the Hotend fan .....	169
Step 7 - Guiding the Hotend fan cables .....	170
Step 8 - LoveBoard: parts preparation I. ....	170
Step 9 - LoveBoard: parts preparation II. ....	171
Step 10 - Assembling the Loveboard-mount .....	171
Step 11 - Assembling the Printhead-cover .....	172
Step 12 - Assembling the LoveBoard .....	172
Step 13 - Guiding the main cable .....	173
Step 14 - Covering the LoveBoard .....	173
Step 15 - Swingarm: parts preparation I. ....	174
Step 16 - Swingarm: parts preparation II. ....	174
Step 17 - Guiding the main cable .....	175
Step 18 - Mounting the main cable .....	175
Step 19 - Attaching the LoveBoard assembly .....	176
Step 20 - Mounting the swingarm .....	176
Step 21 - Attaching the main cable .....	177
Step 22 - Inserting the PTFE tube .....	177
Step 23 - Securing the PTFE tube .....	178
Step 24 - Checking the movement .....	178
Step 25 - Print fan: parts preparation .....	179
Step 26 - Assembling the fan-shroud .....	179
Step 27 - Installing the print fan assembly .....	180
Step 28 - Hotend: parts preparation .....	180

Step 29 - Installing the hotend .....	181
Step 30 - Connecting the heatsink cables .....	181
Step 31 - Connecting the hotend cables .....	182
Step 32 - Connecting the print fan cable .....	182
Step 33 - Connect E-motor cable .....	182
Step 34 - LoveBoard covers: parts preparation .....	183
Step 35 - LoveBoard: Wiring check .....	183
Step 36 - Covering the LoveBoard .....	184
Step 37 - Guiding the main cable .....	184
Step 38 - Haribo time .....	185
Step 39 - Done .....	185
<b>7. Bodywork &amp; Electronics .....</b>	<b>186</b>
Step 1 - Tools necessary for this chapter .....	187
Step 2 - Front profiles: parts preparation .....	187
Step 3 - Installing the front right profile .....	188
Step 4 - Installing the front left profile .....	188
Step 5 - Top profiles: parts preparation .....	189
Step 6 - Assembling the top profiles I. ....	189
Step 7 - Assembling the top profiles II. ....	190
Step 8 - Aligning the top profiles .....	190
Step 9 - Installing the top profiles .....	191
Step 10 - CoreXY fixing screws: parts preparation .....	191
Step 11 - Fixing the CoreXY assembly .....	192
Step 12 - Side sensor base: parts preparation .....	192
Step 13 - Assembling the side sensor base .....	193
Step 14 - Testing the lever .....	193
Step 15 - Assembling the switch .....	194
Step 16 - IR Sensor: parts preparation .....	194
Step 17 - Connecting the IR sensor .....	195
Step 18 - Installing the IR sensor .....	195
Step 19 - Installing the side sensor cover .....	196
Step 20 - Side filament sensor: parts preparation .....	196
Step 21 - Installing the side filament sensor .....	197
Step 22 - Guide the filament sensor cable .....	197
Step 23 - Connecting the side filament sensor .....	198
Step 24 - NFC Antenna: parts preparation .....	198
Step 25 - Applying the adhesive film .....	199
Step 26 - Installing the NFC Coil .....	199
Step 27 - Connecting the NFC Coil .....	200
Step 28 - Wiring check .....	200
Step 29 - Preparing the electronics cover .....	201
Step 30 - Installing the electronics cover .....	201
Step 31 - Buddy3D Camera Note .....	202
Step 32 - xBuddy cover: parts preparation .....	202
Step 33 - Installing the xBuddy cover .....	203
Step 34 - Installing the rear cover .....	203
Step 35 - Right side: parts preparation .....	204
Step 36 - Installing the spoolholder puck .....	204
Step 37 - Right handle: parts preparation .....	205
Step 38 - Installing the collet .....	205
Step 39 - Mounting the handle .....	206
Step 40 - Fixing the right side .....	206
Step 41 - Left side: parts preparation .....	207
Step 42 - Installing the left side .....	207

Step 43 - Haribo time .....	208
Step 44 - Done .....	208
<b>8. Trim, Door &amp; xLCD .....</b>	<b>209</b>
Step 1 - Tools necessary for this chapter .....	210
Step 2 - Top cover: parts preparation .....	210
Step 3 - Removing the foil .....	211
Step 4 - Test-fitting the top cover .....	211
Step 5 - Assembling the top cover I. ....	212
Step 6 - Assembling the top cover II. ....	212
Step 7 - Testing the ventilation .....	213
Step 8 - Installing the top cover .....	213
Step 9 - Side covers: parts preparation .....	214
Step 10 - Removing the foil .....	214
Step 11 - Covering the left side .....	215
Step 12 - Covering the right side .....	215
Step 13 - xLCD: parts preparation .....	216
Step 14 - Important: new xLCD display mount .....	217
Step 15 - Assembling the xLCD I. ....	217
Step 16 - Assembling the xLCD II. ....	218
Step 17 - Installing the FE Faston connector .....	218
Step 18 - Installing the LCD knob .....	219
Step 19 - xLCD bezel: parts preparation .....	219
Step 20 - Mounting the xLCD I. ....	220
Step 21 - Mounting the xLCD II. ....	220
Step 22 - Installing the xLCD assembly .....	221
Step 23 - Securing the xLCD assembly .....	221
Step 24 - Door seal: parts preparation .....	222
Step 25 - Attaching the top seal .....	222
Step 26 - Attaching the side seals .....	223
Step 27 - Magnet holders: parts preparation .....	223
Step 28 - Assembling the magnet holders .....	224
Step 29 - Installing the magnet holders .....	224
Step 30 - Hinges: parts preparation .....	225
Step 31 - Installing the door-hinge-in parts .....	225
Step 32 - Installing the door-hinge-out I. ....	226
Step 33 - Installing the door-hinge-out II. ....	226
Step 34 - Door panel: parts preparation .....	227
Step 35 - Important: new parts .....	227
Step 36 - Door panel: removing the protective film .....	228
Step 37 - Door handle installation method selection .....	228
Step 38 - Installing the door handle (srew-mounted) .....	229
Step 39 - Securing the handle (srew-mounted) .....	229
Step 40 - Installing the door panel .....	230
Step 41 - Assembling the door handle (glued version) .....	230
Step 42 - Securing the door handle (glued version) .....	231
Step 43 - Attaching the sticker: Parts preparation .....	231
Step 44 - Attaching the sticker .....	232
Step 45 - Haribo time .....	232
Step 46 - Done .....	233
<b>9. Calibration &amp; First run .....</b>	<b>234</b>
Step 1 - Belt tensioning .....	235
Step 2 - Installing the spoolholder: Parts preparation .....	235
Step 3 - Attaching the print sheet and spoolholder .....	236
Step 4 - Firmware Download .....	236

Step 5 - Turning on the printer .....	237
Step 6 - Setting up the printer: Intro .....	237
Step 7 - Setting up the printer: Network setup .....	238
Step 8 - Wizard: Intro .....	238
Step 9 - Wizard: Door Sensor Calibration .....	239
Step 10 - Wizard: Loadcell Test .....	239
Step 11 - Wizard: Gearbox Alignment .....	240
Step 12 - Wizard: Filament Sensor Calibration .....	240
Step 13 - Wizard complete .....	241
Step 14 - Setting the printer up .....	241
Step 15 - Haribo time .....	242
Step 16 - Handbook .....	242
Step 17 - Firmware update .....	243
Step 18 - Give us feedback .....	243
Step 19 - Prusa knowledge base .....	244
Step 20 - Join Printables! .....	244
<b>Manual changelog .....</b>	<b>245</b>
Step 1 - Version history .....	246
Step 2 - Changes to the manual (1) .....	246
Step 3 - Changes to the manual (2) .....	247



# 1A. Introduction



## STEP 1 Guide Info



- ◆ Welcome to the Original **Prusa MK4S to CORE One+ Conversion** guide.
- ◆ Please prepare the upgrade kit received from Prusa Research.
- ◆ In the first part of the guide, we will check the key components of your MK4S printer, followed by printer disassembly.

Next, we will rework a few parts, and finally, the CORE One+ build process may begin.

## STEP 2 How to navigate through the manual

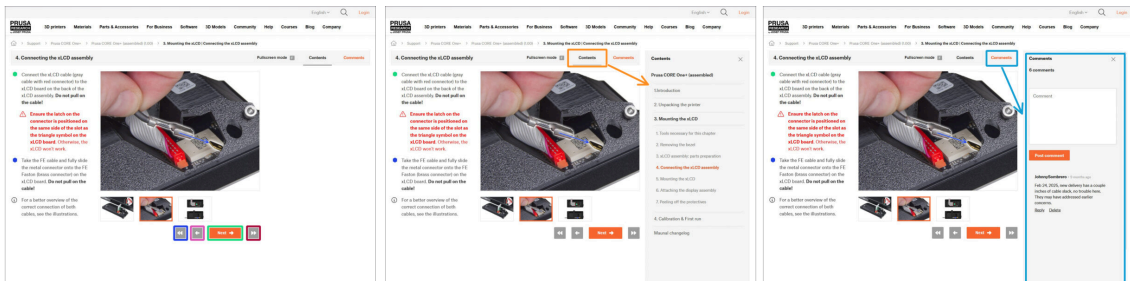

- ◆ Use the graphical navigation buttons in the bottom right corner or the arrow keys on your keyboard:
  - ◆ **Next button / Right arrow key** - Moves to the next image, or to the next step if it's the last image in the step.
  - ◆ **Left arrow button / Left arrow key** - Moves to the previous image, or to the previous step if it's the first image in the step.
  - ◆ **Play backward button / Up arrow key** - Moves to the previous step.
  - ◆ **Play forward (Next) button / Down arrow key** - Moves to the next step.
- ◆ Click on **Contents** to expand the full list of steps in this guide. This allows you to jump to any step regardless of the sequence.
- ◆ Click on **Comments** to open the discussion for a specific step and leave your feedback.

## STEP 3 View high resolution images

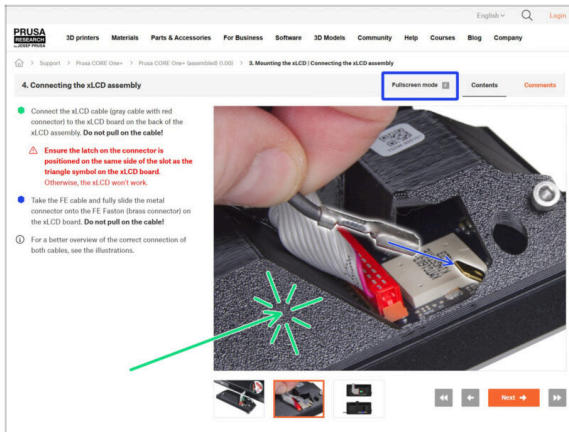

- When you browse the guide on [help.prusa3d.com](https://help.prusa3d.com), you can view the original images in high resolution for clarity.
- Just click on the image to open it in high resolution for a detailed view.
- Click on **Fullscreen mode** or press the F key to maximize your screen space and focus entirely on the instructions.

## STEP 4 Compatibility

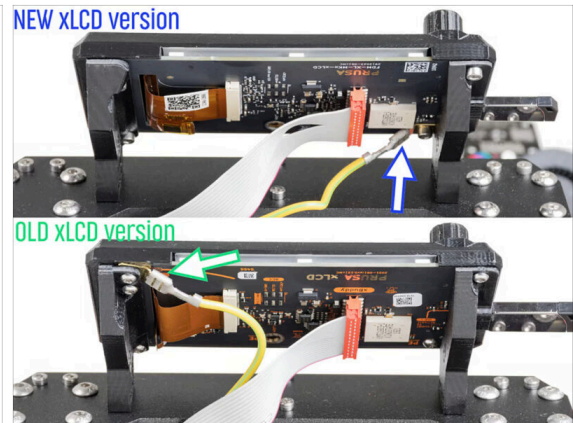

**⚠** The only conversion option to CORE One+ is from the **MK4S**.

If you have an older printer model, you must first upgrade it to MK4S, then proceed with the CORE+ One conversion.

**i** There are two versions of the conversion package, depending on the xLCD version used in your MK4S printer.

**⚠** The silver PSU is not compatible with the conversion kit.

If you have this PSU version, you will need to purchase a compatible one.

For more info, see the compatibility notes on the CORE One+ Conversion e-shop page.

## STEP 5 Important: Electronics protection

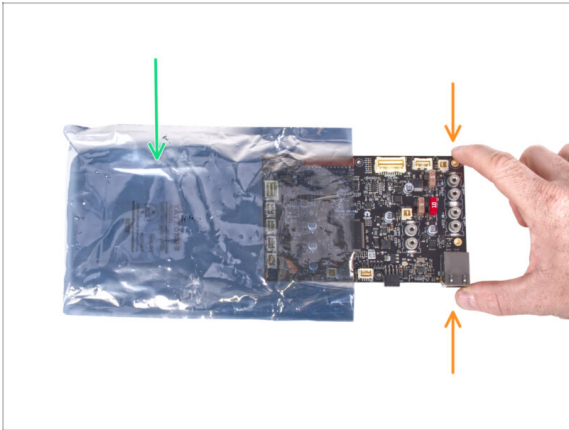

**⚠ WARNING:** Make sure to **protect the electronics against electrostatic discharge (ESD)**. When possible, always unpack the electronics right before you need them.

- Here are some tips to prevent damage to the electronics:
  - **Keep the electronics inside an ESD-safe bag** right until you are asked to install them.
  - **Always touch the sides of the board only** while handling it. Avoid touching the components on the surface.
  - **Before you touch the electronics** use any grounded conductive (metal) structure nearby to neutralize the possible static charge from your hands.
  - Be extra cautious **in rooms with carpets**, which are often a source of electrostatic energy.
  - Clothes made of wool or certain synthetic fabrics can easily gather static electricity too. It is safer to wear cotton clothing for the assembly.

## STEP 6 Labels guide

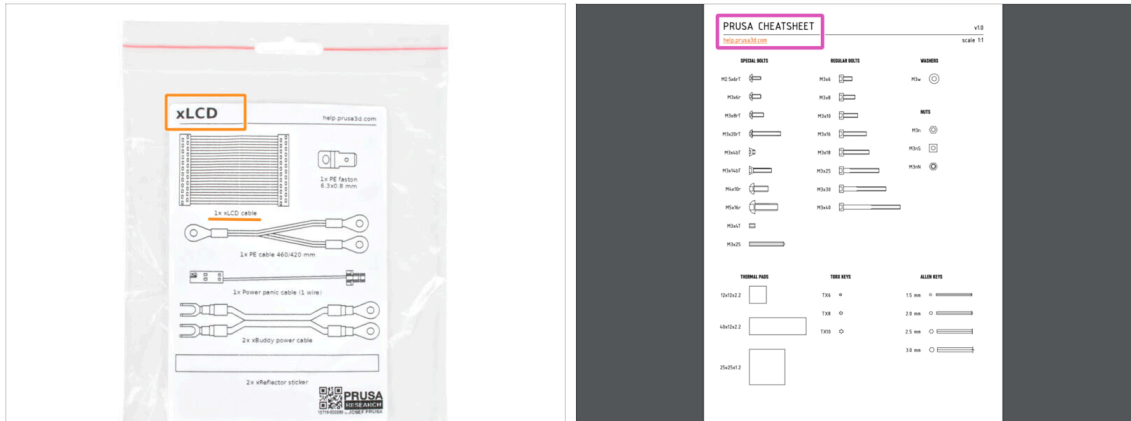

- All the boxes and bags including parts for the build are labeled.
- The labels include the list of contents and part count.
- You can download a **Cheatsheet** with 1:1 fastener drawings from our site [prusa.io/cheatsheet-mk4](http://prusa.io/cheatsheet-mk4). Print it at 100 %, don't rescale it, otherwise, it won't work.
- ❗ For PRUSA veterans: Fasteners are divided into individual bags according to its type. Not into packages for individual chapters, as it was with previous printers.

## STEP 7 Spare bag



- There is a bag with spare parts like thermal pads, springs, etc.
- Spare fasteners are included in each bag of fasteners. The numbers in parentheses below the fastener picture indicate the number of extra pieces added to the SPARE package.

## STEP 8 We are here for you!

The screenshot shows the Prusa 3D printer support page for step 4, 'Connecting the xLCD assembly'. The page includes instructions, a video, and a comments section. A pink arrow points from the 'Chat now' button in the bottom right corner to the 'SUBMIT' button in the comments section.

**4. Connecting the xLCD assembly**

- Connect the xLCD cable (gray cable with red connector) to the xLCD board on the back of the xLCD assembly. **Do not pull on the cable!**
- Ensure the latch on the connector is positioned on the same side of the slot as the triangle symbol on the xLCD board. Otherwise, the xLCD won't work.
- Take the FE cable and fully slide the metal connector onto the FE Fasten (brass connector) on the xLCD board. **Do not pull on the cable!**
- For a better overview of the correct connection of both cables, see the illustrations.

**Comments**

5 comments

Oh look at the detail!

Post comment

JohnyFambers · 1 year ago  
Feb 24, 2025, new delivery had a couple inches of cable slack, no trouble here. They may have addressed earlier concerns.  
Reply · Delete

POWERED BY TINY

SUBMIT

Chat now

- 🛡️ Lost in the instructions, missing screw or cracked printed part? **Let us know!**
- 🛡️ You can contact us using the following channels:
  - 🔵 Using comments under each step.
  - 🟣 Using our 24/7 live chat here at [help.prusa3d.com](https://help.prusa3d.com)
  - 🛡️ Writing an email to [info@prusa3d.com](mailto:info@prusa3d.com)

## STEP 9 Pro tip: inserting the nuts

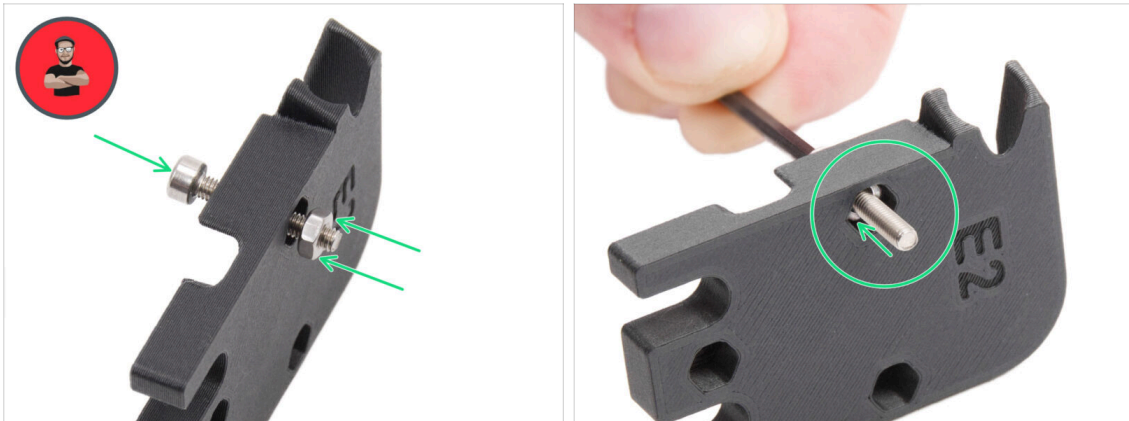

- 3D printed parts are very precise, however, there still might be a tolerance in the printed part and the same goes for the size of the nut.
- Therefore it might happen, that the nut won't fit easily in or might be falling out. Let's see, how to fix it:
  - **Nut won't fit in:** use a screw with a thread along its entire length (typically: M3x10, M3x18) and screw it from the opposite side of the opening. While tightening the screw, the nut will be pulled in. Remove the screw afterwards.
  - **Nut keeps falling out:** Use a piece of tape to fix the nut temporarily in place, as soon as you insert the screw in, you can remove the tape. *Using glue isn't recommended as it can partly reach into the thread and you won't be able to tighten the screw properly.*
- Every time we recommend using the "screw pulling technique", you will be reminded with Joe's avatar ;)
- ⓘ Parts in the pictures are used as an example.

## STEP 10 Bearing Lubrication Pacifier



- ◆ We will reuse two LM8UU bearings from your MK4S. It is a good practice to re-lubricate them before re-using.
- ◆ For this purpose, we suggest printing the Bearing Lubrication Pacifier from Printables, Before disassembling the printer
- ⓘ It is a quick print, just under 20 minutes.
- ◆ The lube tube is included in the package.

## STEP 11 Prepare your desk



- ◆ Tidy up your desk! Tidying up decreases the probability of losing small parts.
- ◆ **Clear your workspace.** Make sure you have enough room. A nice clear flat workbench will get you the results you are aiming for.
- ◆ **Let there be light!** Make sure you are in a well-lit environment. Another lamp or even an extra flashlight will probably come in handy.
- ◆ Prepare something to contain the plastic bags and the removed packing materials so you can recycle them afterwards. Make sure there are no important parts being discarded.
- ⚠ **It's highly recommended to place a soft pad on your workbench. Some sheet metal parts have sharp edges that could scratch the surface.**
- ◆ OK, we are ready. Let's start! Go to the next chapter.

## 1B. MK4S Inspection

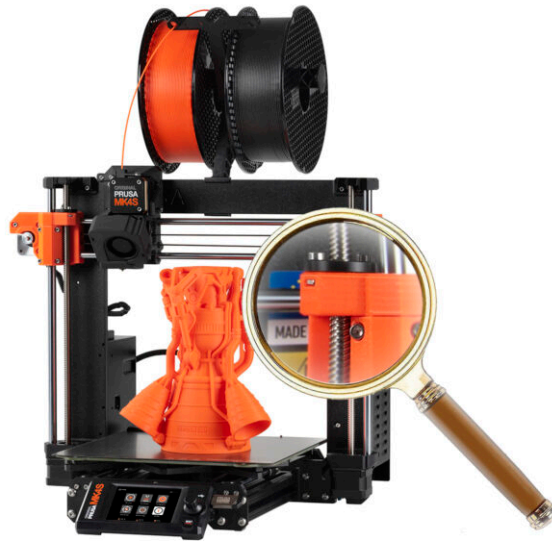

## STEP 1 Introduction



- Some parts of your printer can be reused for upgrading, so it's essential to check their condition before starting.

This chapter will guide you through a visual inspection of these parts. If you find any in poor condition, you'll have enough time to order replacements while still using the printer.

**⚠ Do not disassemble or disconnect anything until prompted.**

- Any parts that are found to be in poor condition during the inspection can be replaced with new parts. Everything is available in our eshop.

**i** Please note that you have to be logged in to access all parts.

## STEP 2 Firmware Update

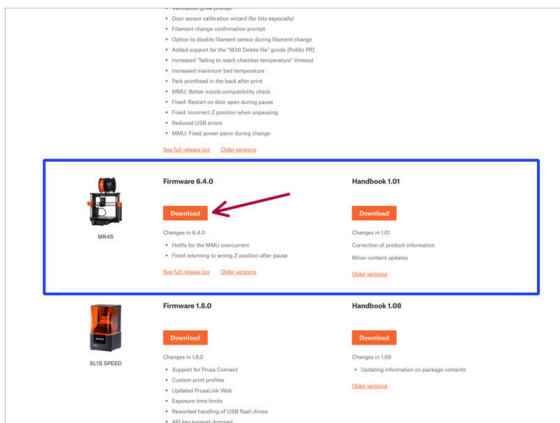

- On the printer, visit the menu **Info > Version Info** to check the firmware version.

**⚠ Ensure your MK4S printer has **firmware 6.4.0 or newer** before continuing. Otherwise, your newly converted CORE One will not work and will resist updating.**

- The latest firmware can be downloaded at: [Help.Prusa3D.com/Downloads](https://help.prusa3d.com/downloads)
- For more info, visit the [Firmware Update Article](#).

## STEP 3 Printer Preparation 2



### Before you start, do the following:

- Move the X-axis assembly approximately to the 2/3 height, so that:
  - i Pro Tip: Long press the knob and use the "Z Axis Move" option.
  - The rear of the extruder is accessible.
  - The PSU screws are accessible.
  - All the screws on the electronics box are accessible.

## STEP 4 Printer Preparation 2

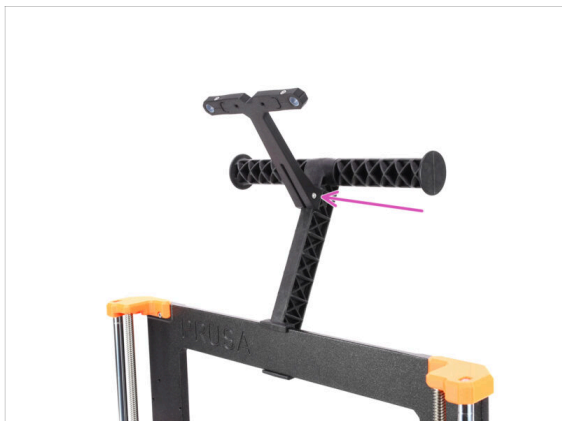
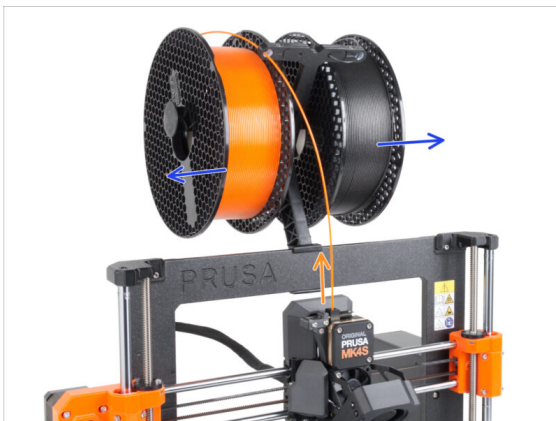

- Unload a filament, if it is loaded.
  - i Menu Filament > Unload filament
- Remove the filament spools.
- Remove the spool holder.

## STEP 5 Printer Preparation 3



- Turn off your printer and disconnect it from the power.
- Remove the print sheet and save it for later use.

## STEP 6 Heatbed Inspection

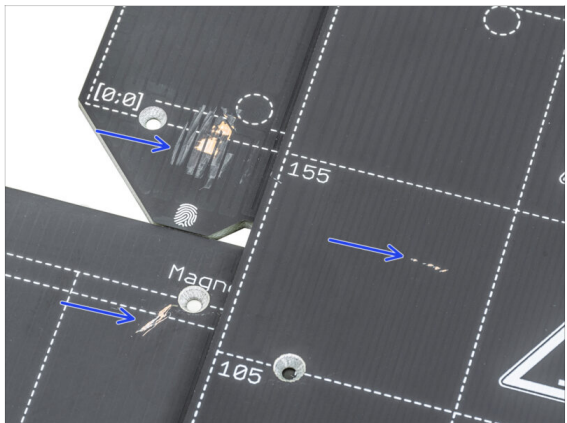
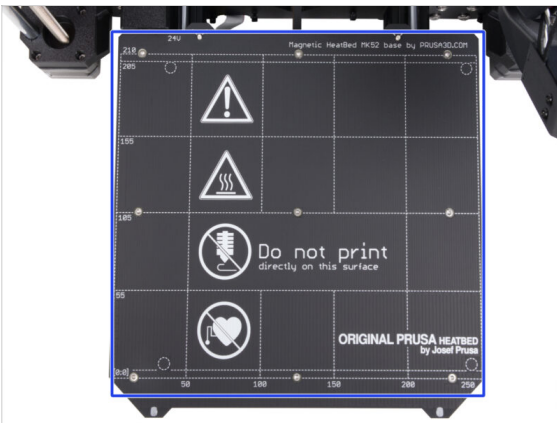

- Carefully inspect the surface of the heatbed. If you find any major scratches (up to the copper layer) consider replacing it with a new piece.

## STEP 7 Y-Rods Inspection



- Wipe the entire length of the Y-axis smooth rods with a paper towel to remove any dirt.

**i** Carefully inspect the surface of the smooth rods up close, as we are going to reuse them.

- The surface must be clean and smooth.
- If you find very deep scratches, corrosion, or a rough surface, it is highly recommended to replace the rods.

You can purchase a new Smooth Rod Y-axis (8×330 mm) in our eshop

- Similarly, if the smooth rods are scratched or the bearings do not move smoothly (stuttering occurs), we recommend ordering new LM8UU bearings as well.

You can purchase new LM8UU bearings in our eshop.

## STEP 8 Haribo?



**!** **Keep the Haribo bag closed for now!**

- This dose of energy is primarily for the printer assembly. **Wait until you are prompted to open it.**

## STEP 9 Get Started

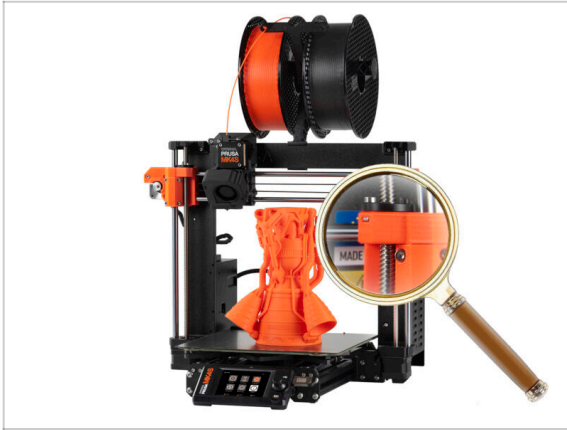

- ◆ Got everything checked? Great! Let's begin disassembling the printer.

Proceed to the next chapter.

## 1C. Printer Disassembly

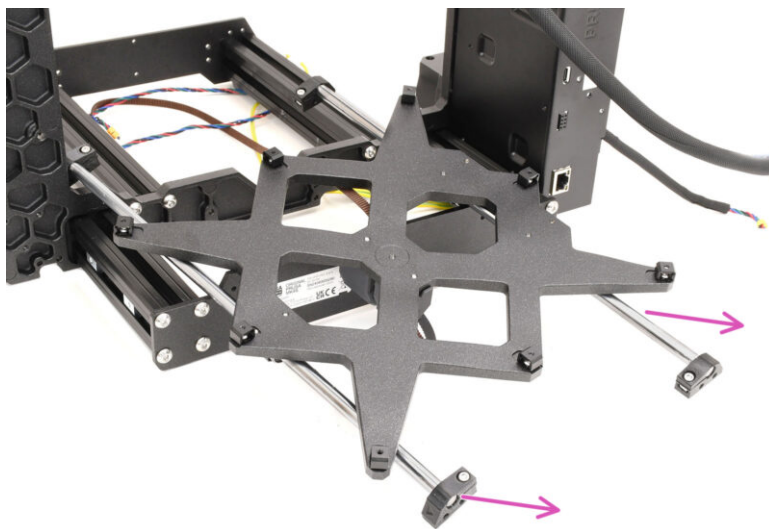

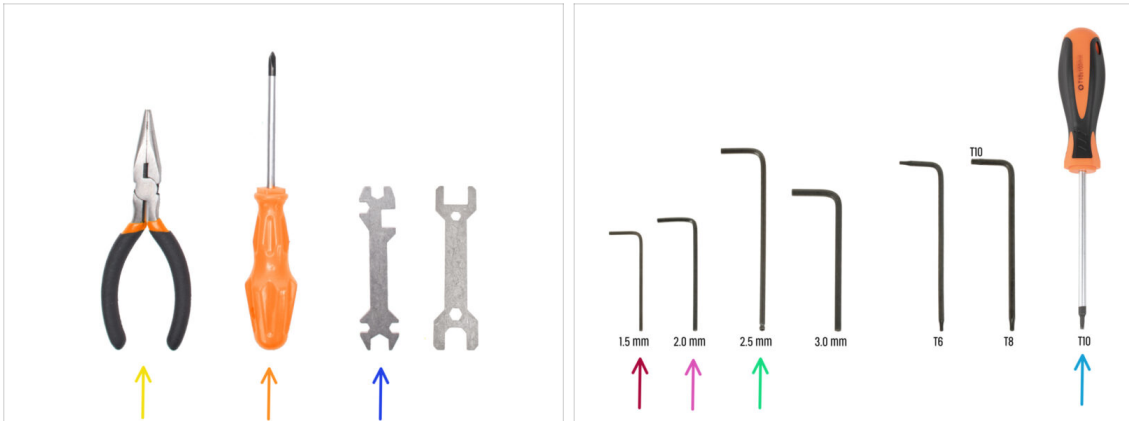
**STEP 1** Tools Required

● **For this chapter, please prepare:**

- Needle-Nose Pliers
- Phillips Screwdriver
- Universal wrench
- 1.5mm Allen key
- 2mm Allen key
- 2.5mm Allen key
- T10 Screwdriver

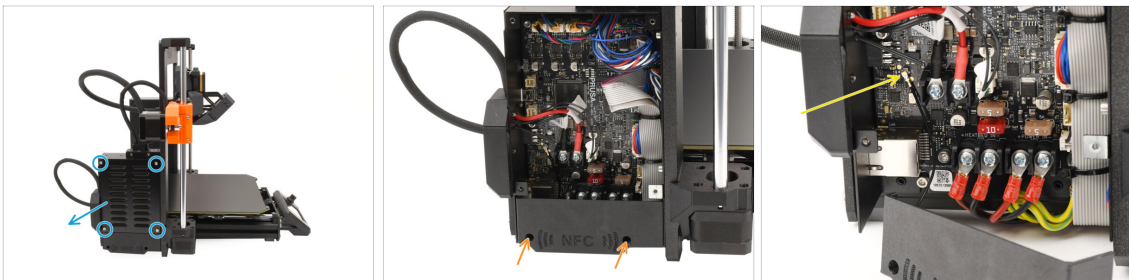
**STEP 2** Electronics Disassembly

- Let's move onto the **left** side of the printer.
- Remove the four screws holding the xBuddy box cover and remove the cover.
- Using the 2.5mm Allen key, remove the two screws holding the NFC cover.
- Disconnect the NFC antenna from the xBuddy board by gently lifting the tiny connector.

Then, remove the antenna along with the cover.

### STEP 3 Wi-Fi Disassembly

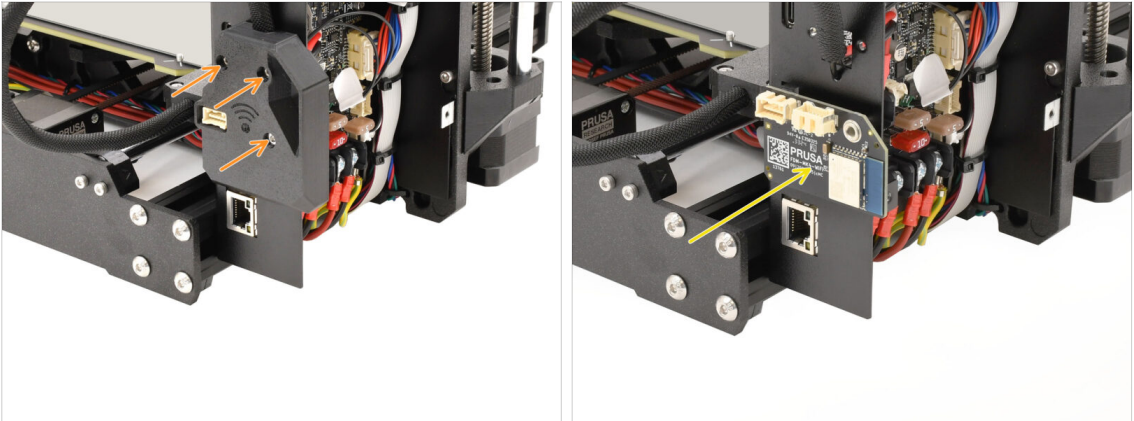

- On the back of the electronics box, remove the three screws holding the Wi-Fi cover and remove the cover.
- Remove the Wi-Fi module and **save it for later use**.
- ⚠ Ensure you store the module and all electronic components in an ESD-safe environment to prevent damage!

### STEP 4 Cable Bundle Disassembly

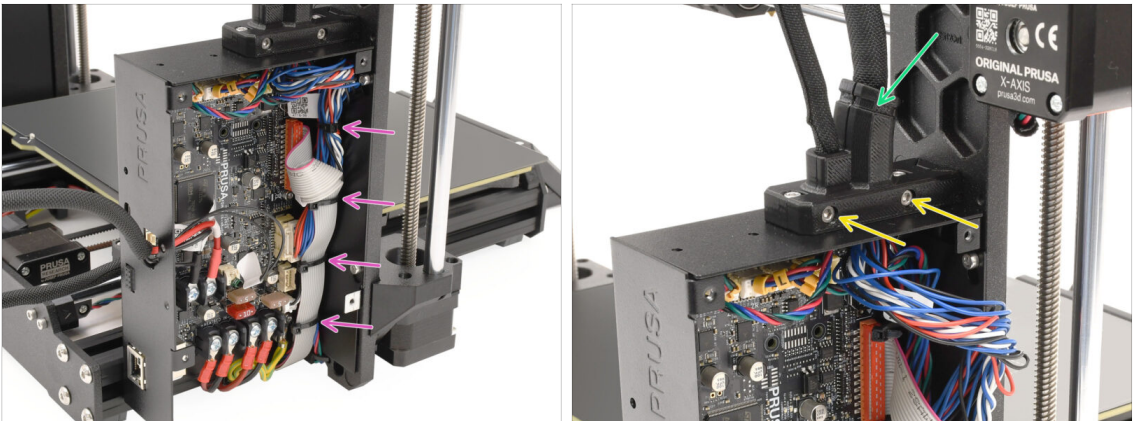

- Remove all the zip-ties securing the cable bundle inside the xBuddy box.
- ⚠ When cutting the zip-ties, proceed carefully to prevent any damage to the cables or the electronics!
- Remove the two screws on the main cable holder.
- Cut the zip-tie holding the cover together, then remove the outer part of the holder.

## STEP 5 Cables Disconnecting 1

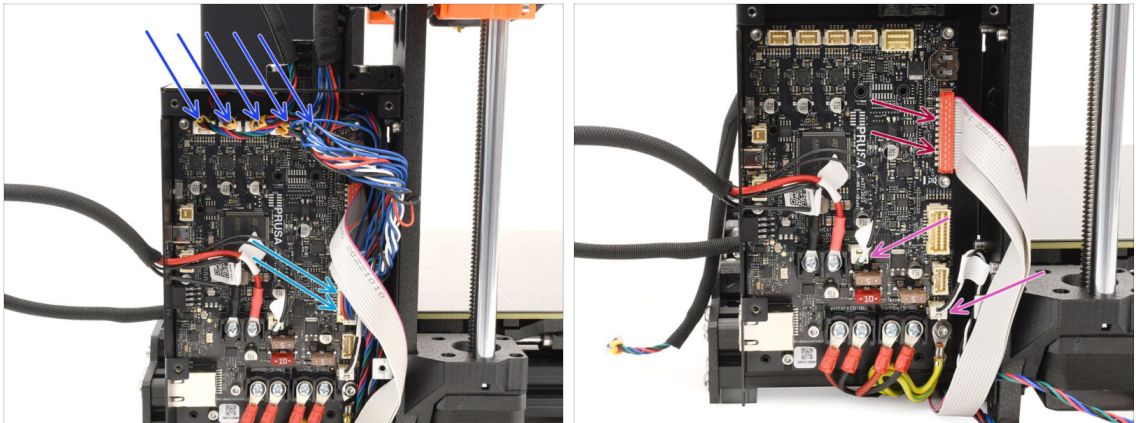

- ◆ Disconnect all the connectors on the top of the xBuddy board.
  - ⚠ There is a safety latch on each of these connectors, which must be pressed in order to disconnect it.
- ◆ Disconnect the extruder main cable connector.
- ◆ Disconnect the heatbed thermistor and power panic cables.
- ◆ Disconnect the xLCD connector by lifting it carefully up.

## STEP 6 Cables Disconnecting 2

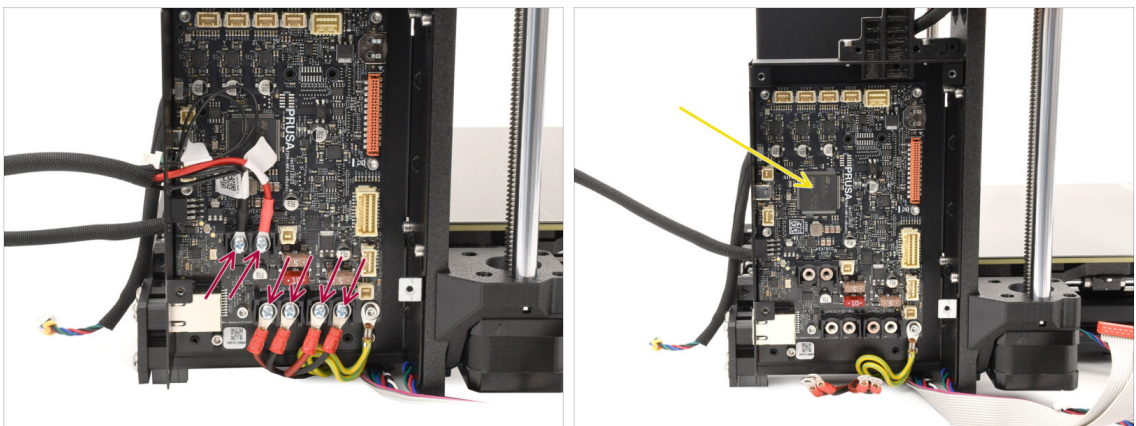

- ◆ Using the Phillips screwdriver, remove all the terminal screws holding the heatbed and power cable connectors.
- ◆ Leave the xBuddy board in the electronics box for now, as this way, it is well protected from damage.

## STEP 7 Cable Budle Release

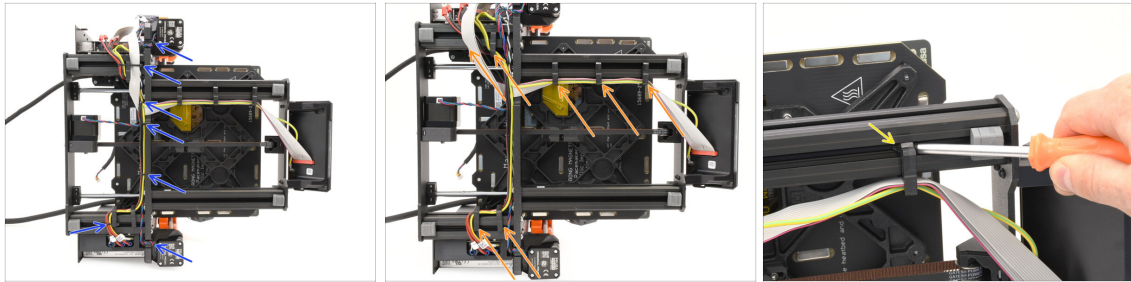

- Lay the printer onto the PSU side to access the bottom part.
- Carefully remove all the zip-ties holding the cable bundle
- Remove all the cable holders from the frame and detach them from the cables.
  - Pro tip: You can pry them off the metal profiles using the screwdriver.

## STEP 8 xLCD Removal

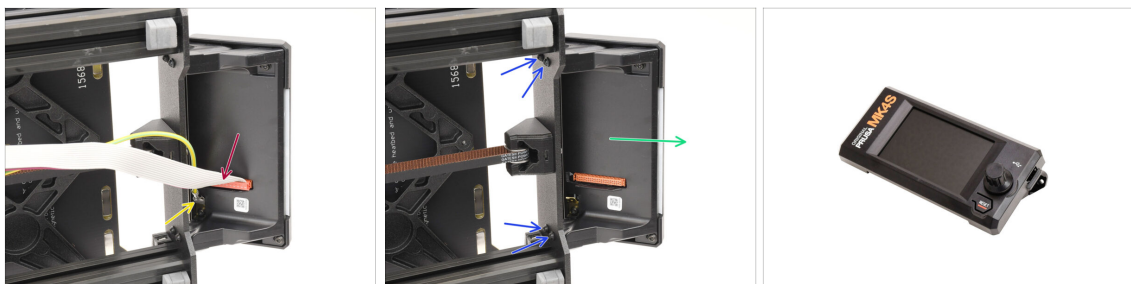

- Disconnect the main cable from the xLCD by gently lifting the connector up.
- Disconnect the grounding cable.
- Using the T10 screwdriver, remove the four screws holding the xLCD assembly.
- Remove the xLCD assembly and **save it for later use!**

## STEP 9 Y Idler Removal

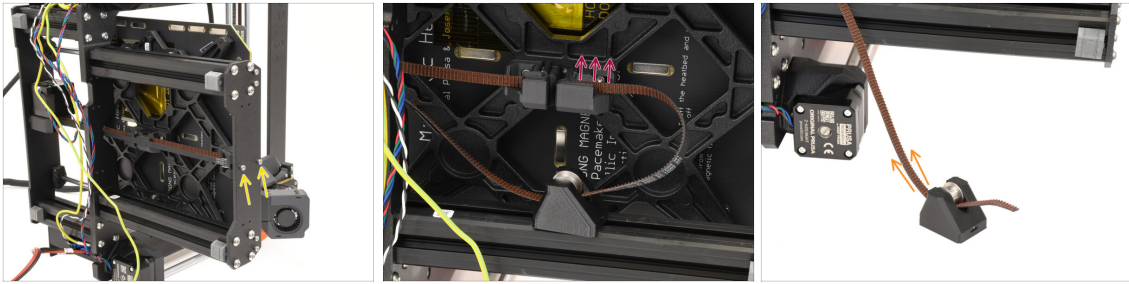

- ✦ Using the 2.5mm Allen key, remove the two screws holding the Y-Axis Idler on the front plate.
- ✦ Pull the end of the Y-axis belt out of the holder at the bottom of the heated bed to disengage it.
- ✦ Remove the belt from the idler by pulling it out.

## STEP 10 Idler Pulley Removal



- ✦ Orient the Y-Idler as shown in the picture.  
Remove the pulley by first moving it inward, then pulling it out to the side.  
Refer to the groove pattern in the picture for the correct trajectory.
- ✦ Remove the center shaft from the pulley.
- ✦ **Save the pulley for later use.**

## STEP 11 Y Motor Removal

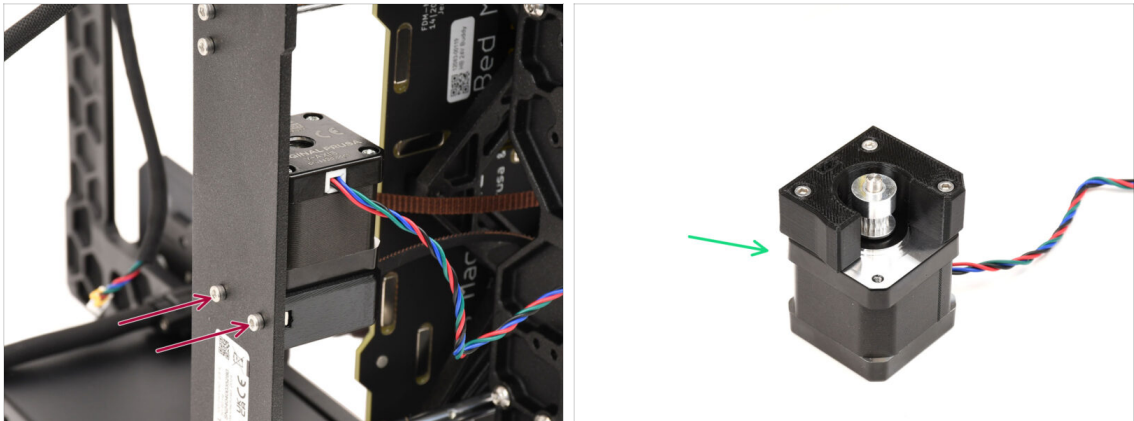

- ◆ Remove the two screws on the back of the printer, holding the Y-axis motor in place.
- ◆ Remove the Y-axis motor assembly and **save it for later use**.

## STEP 12 Power Panic Cable Removal

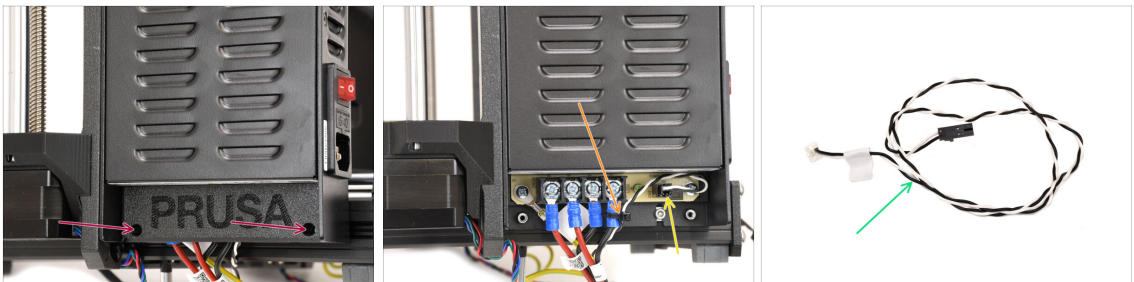

- ◆ Let's move onto the right side of the printer carcass, where the PSU lives.
- ◆ Remove the two screws securing the cover, then take off the cover.
- ◆ Carefully cut off the zip-tie holding the power panic cable.
- ◆ **Save the power panic cable for later use.**
- ⓘ The power panic cable may look different, depending on your xBuddy board version.

## STEP 13 Power Cable Removal

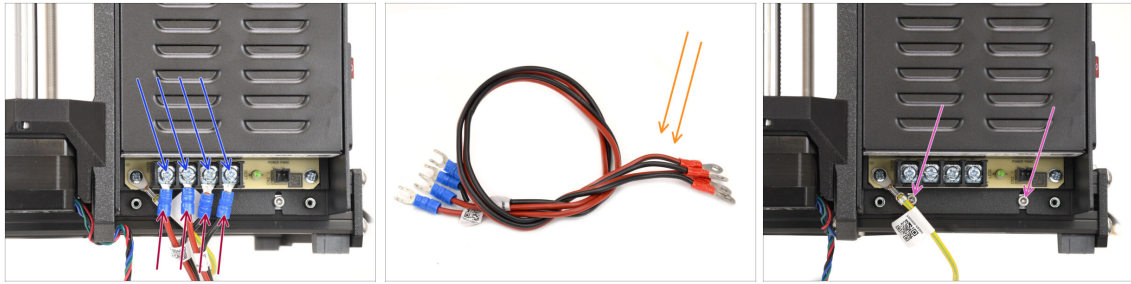

- ◆ Using the Phillips screwdriver, loosen the four power terminal screws. Do not remove them entirely.
- ◆ Remove the four power cable connectors by pulling them downward.
- ◆ Remove the power cables and **save them for later use**.
- ◆ Using the 2.5mm Allen key, remove the two screws holding the PSU to the printer's frame.

## STEP 14 PSU Removal 1

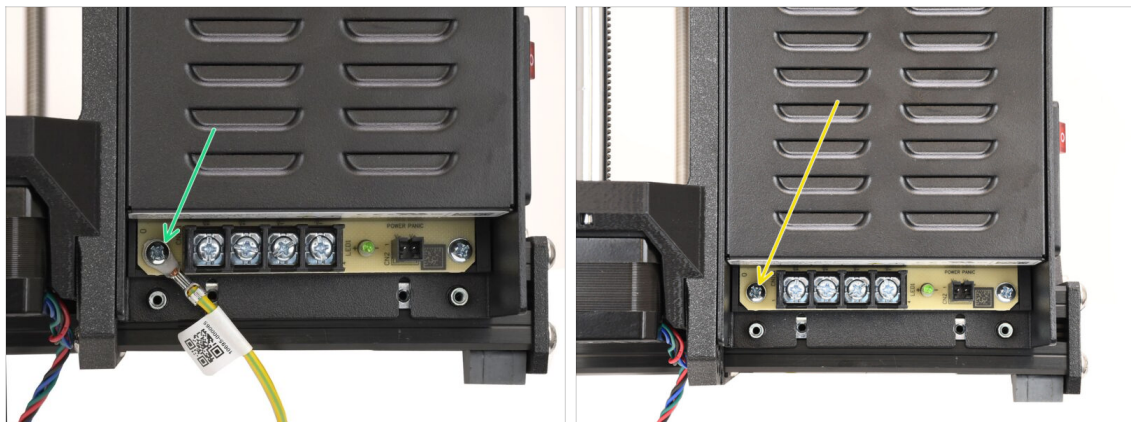

- ◆ Remove the screw holding the grounding cable to the PSU.
  - ◆ Disconnect the grounding cable—it will no longer be needed.
- ◆ Re-install the screw you previously removed.

## STEP 15 PSU Removal 2



- On the front of the frame, remove the two screws holding the PSU.

⚠️ **The PSU might fall off to the side!**

- Remove the PSU and **save it for later use.**

## STEP 16 Heatbed Removal

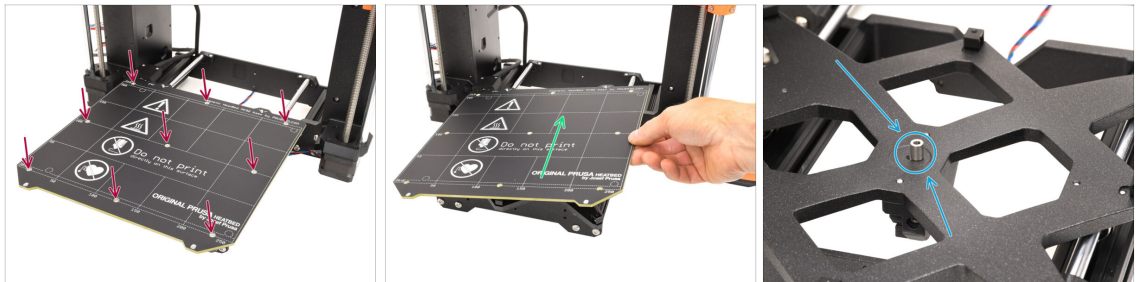

- Let's move onto the heatbed.

- Using the T10 Torx screwdriver, remove all 9 screws holding the heatbed.

- Remove the heatbed by lifting it up. **Save it for later use.**

- There is a spacer in the middle of the heatbed. Make sure to save it for later use too!

📌 Be careful and store the heatbed on a soft surface to prevent scratching it.

**STEP 17** Y-Axis Removal

- ◆ Using the 2.5mm Allen key, remove the four screws holding the Y-axis rods to the front of the frame.
- ◆ Remove the four screws holding the Y-axis rods to the back of the frame.
- ◆ Remove the whole Y-axis assembly from the printer's frame.

**STEP 18** Y-Axis Disassembly

- ◆ Remove the four screws fixing the rods to the Y-rod holders. Then, remove the plastic rod holders.
- ◆ Turn the assembly around.
- ◆ Pull out both the Y-axis rods. Clean them up and **save them for later use**.
- ◆ Remove all the screws holding the bearings to the carriage.

## STEP 19 Bearings Removal

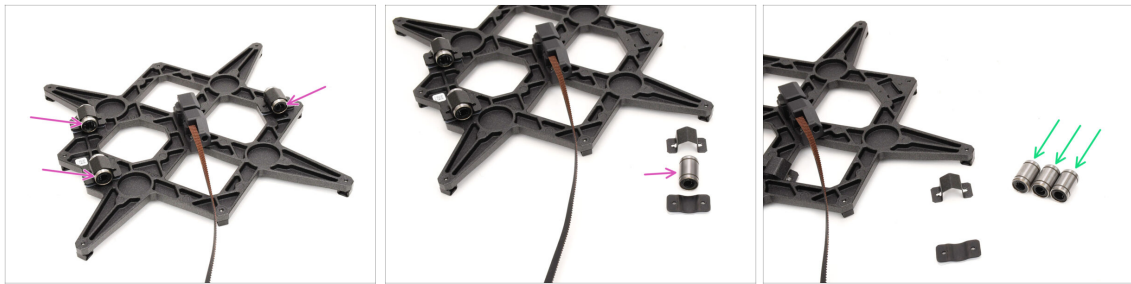

- ◆ Remove all three bearings from the bearing holders.
- ◆ Clean the bearings from any excess grease or dirt, and **save them for later use**.
- ⓘ Two of this type of bearings will be used to build the CORE One+.

## STEP 20 Expansion Joint Removal



- ◆ Using the 2mm Allen key, remove all 8 expansion joints from the Y-Carriage.
- ◆ **Save the expansion joints for later use.**

## STEP 21 Extruder Cover Removal

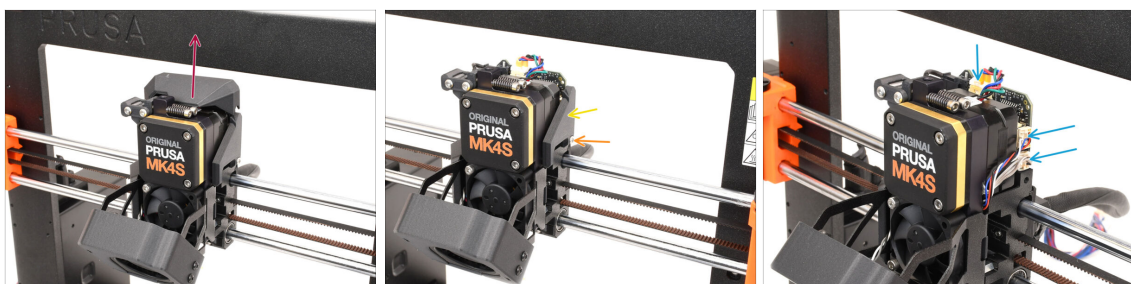

- ◆ Let's move onto the extruder.
- ◆ Remove the top cover on the extruder by lifting it up.
- ◆ Remove the screw holding the cover on the right side.
- ◆ Remove the side cover.
- ◆ Disconnect the motor, filament sensor and loadcell cables.

## STEP 22 Hotend Assembly Removal

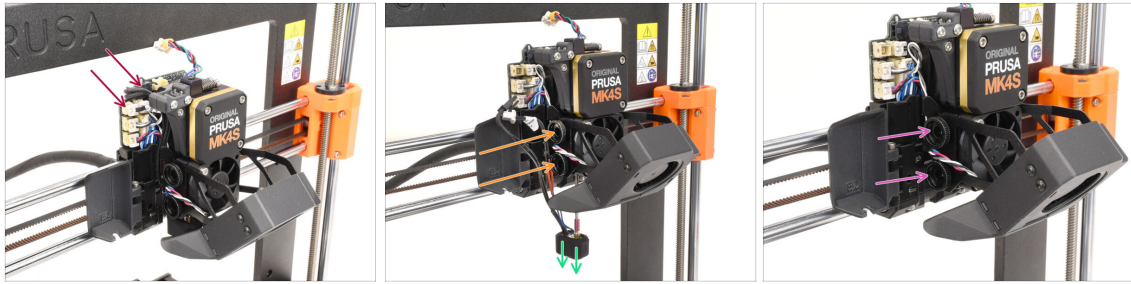

- ◆ On the opposite side, disconnect the nozzle thermistor and nozzle heater cables.
- ◆ Release the two thumb screws, until the hotend assembly drops.
- ◆ Remove the hotend assembly and **save it for later use**.
- ◆ Remove the two thumb screws and save them for later use.

## STEP 23 Print Fan Removal

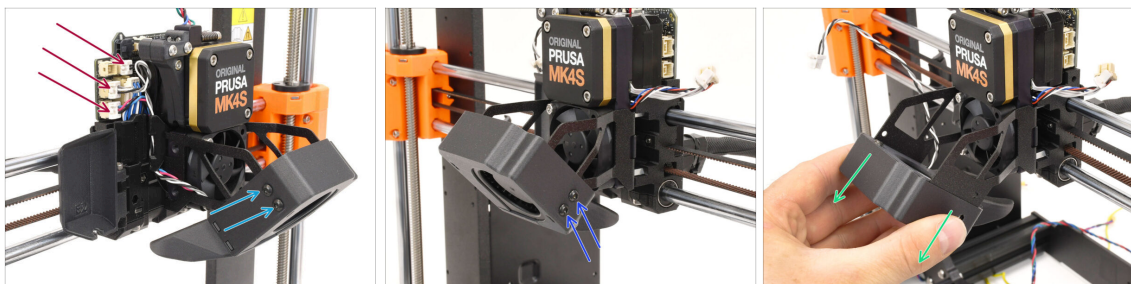

- ◆ Disconnect the cables on the left side of the Nextrunder.
- ◆ Using the T10 screwdriver, remove the two screws holding the print fan on the left side.
- ◆ Remove the two screws on the right.
- ◆ Remove the print fan assembly by sliding it out. Proceed carefully to prevent damaging the cable going through the metal holder. **Save the fan assembly for later use!**

## STEP 24 Heatsink Fan Removal

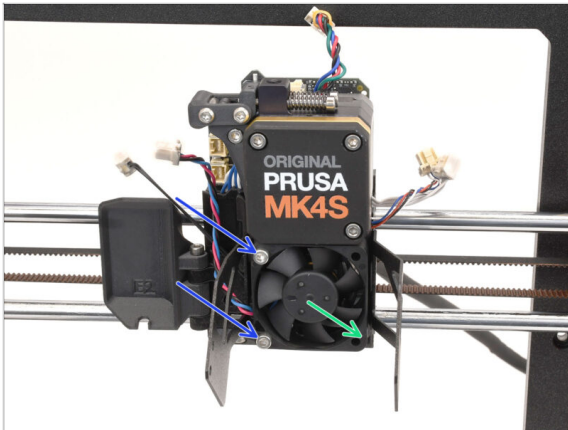

- Remove the two screws holding the hotend fan to the heatsink.
- Remove the fan and **save it for later use**.
- Proceed carefully to prevent damaging the cable.

## STEP 25 Nextruder Removal

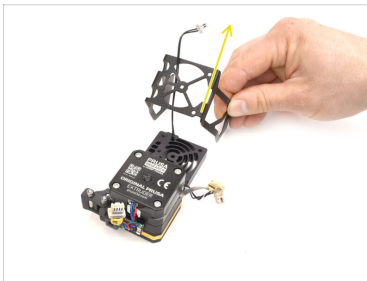
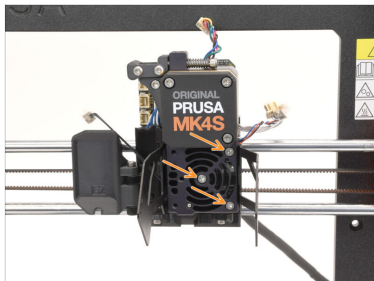

- Remove the three screws holding the Nextruder to the X-carriage.  
**⚠ Watch out! The Nextruder might fall out!**
- Remove the Nextruder from the printer.
- Remove the Print fan support and a plastic spacer (if present). Proceed carefully to prevent damaging the heatsink thermistor cable.
- Save the Nextruder for later use.**

## STEP 26 LoveBoard Removal

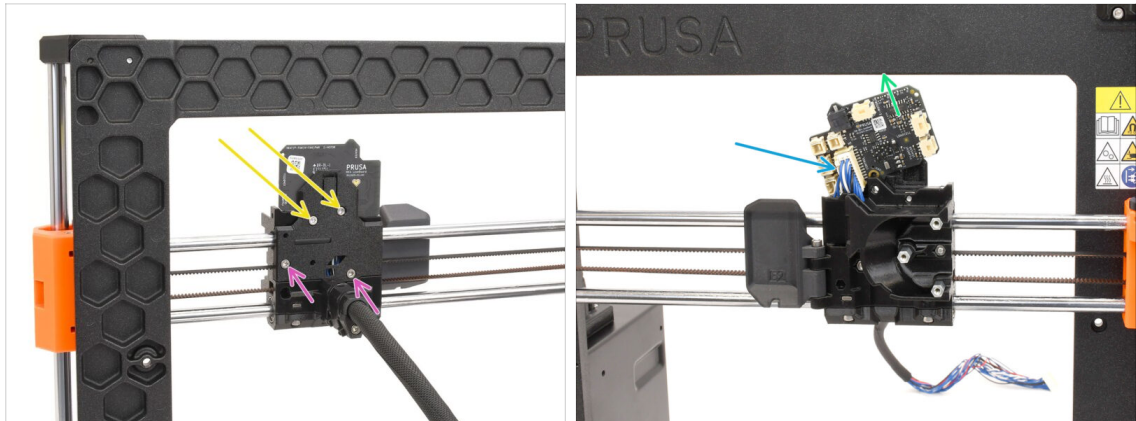

- Move onto the back of the X-carriage.
- Remove the two marked screws on top of the backing plate.
- Loosen the two remaining screws, but do not remove them entirely yet.
- Lift the Loveboard slightly to disconnect it from the main cable. Proceed carefully to prevent any damage to the Loveboard.
- **Remove the Loveboard and save it for later use.**

## STEP 27 Z Motors Removal

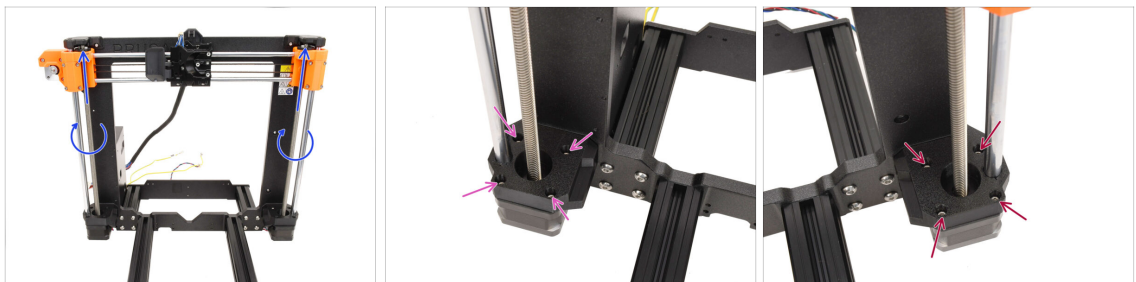

- Rotate both threaded rods by hand to move the X-axis assembly all the way to the top.
- Using a ball-end 2.5mm Allen key, remove all 4 screws securing the left Z motor.
- Remove the 4 screws holding the right Z motor as well.

## STEP 28 Z Motors Removal 2

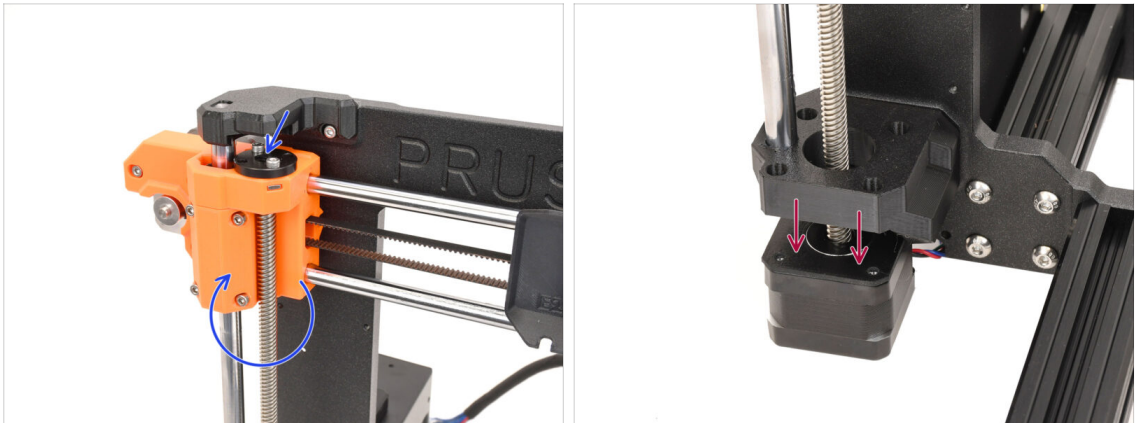

- ◆ Rotate the threaded rods on both sides to disengage both the motors from the trapezoid nuts on the X-End parts.
- ◆ Disengage the motors on both sides from the holders. The X-axis will drop slightly.

## STEP 29 Z Motors Removal 3

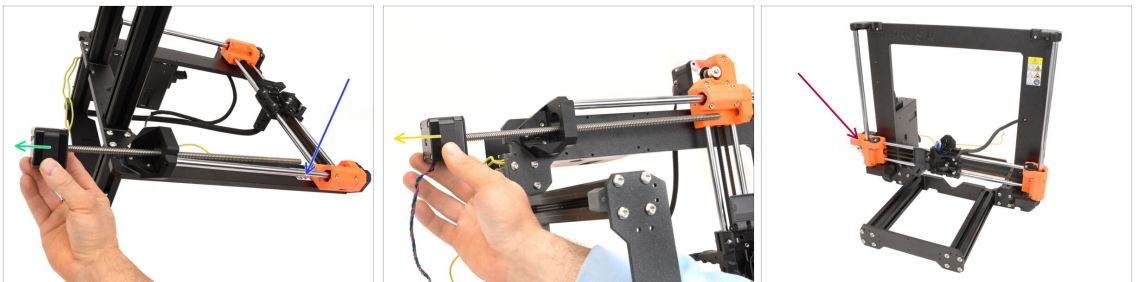

- ◆ Lay the frame onto its back part.
- ◆ Remove the right Z motor by sliding it out. **Save it for later use.**
- ◆ Remove the left Z motor. **Save it for later use.**
- ◆ Move the frame back to the original position. **Expect that the X-axis now moves freely and may fall rapidly.**

## STEP 30 Z Rods Removal

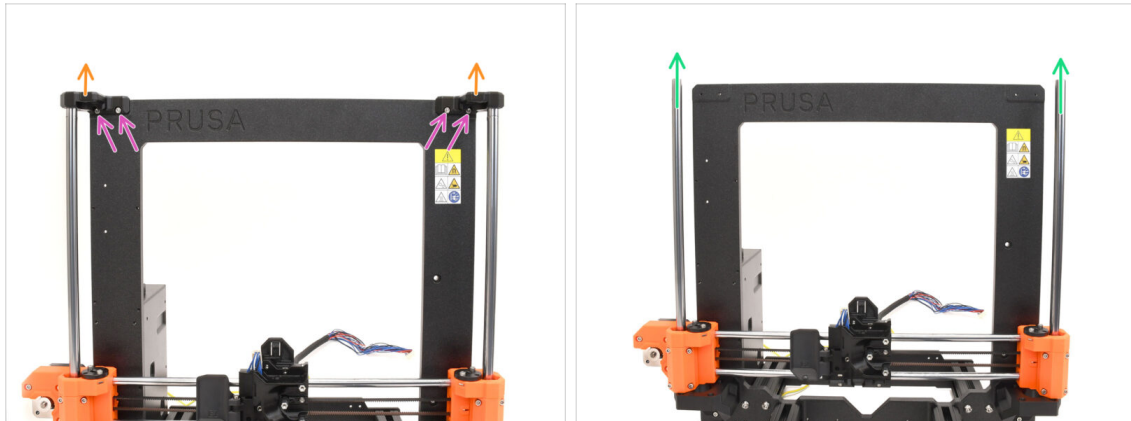

- ◆ Remove the four screws holding the Z-top parts on both sides.
- ◆ Remove both Z-tops by pulling them up and disengaging from the rods.
- ◆ Pull up both Z rods and remove them from the printer. **Save both rods for later use.**
- ⓘ A slight wiggling motion may help to disengage them from the plastic part.

## STEP 31 Trapeze Nut Removal

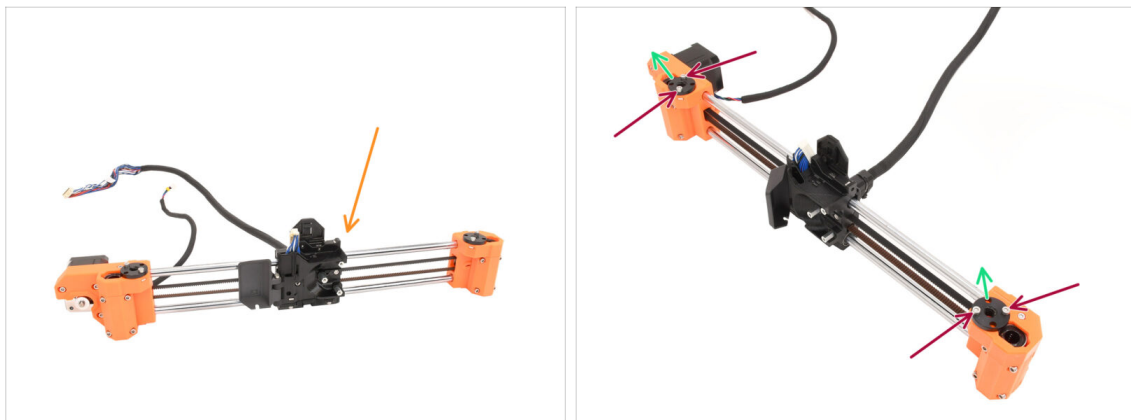

- ◆ Remove the X-axis assembly from the printer's frame.
- ◆ Remove the four screws holding the trapezoid nuts on top of both sides of the assembly.
- ◆ Remove both the trapezoid nuts and **save them for later use.**
- ⓘ If the nuts are hard to remove, try rotating them, while pulling them up. If that doesn't help, carefully use the threaded rod on one of the Z-motors, to pry them out.

## STEP 32 X Motor Release

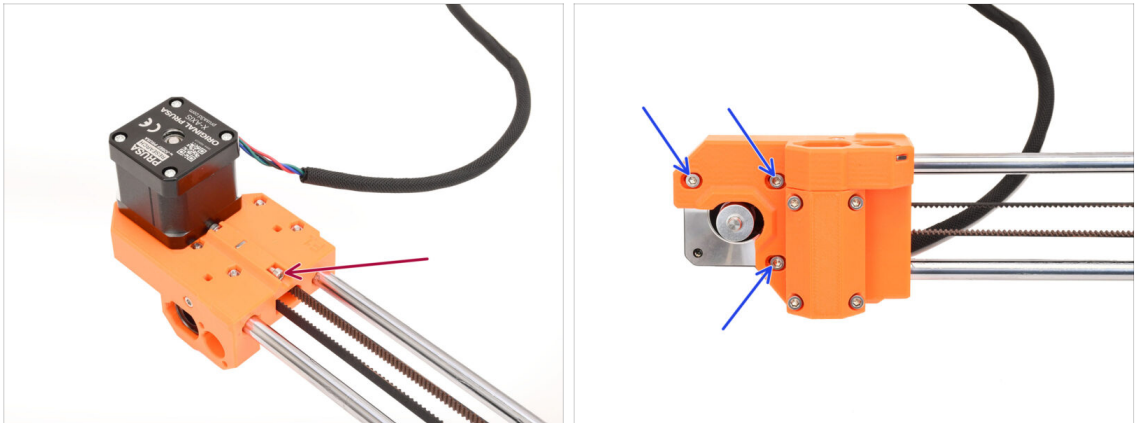

- ◆ On the back of the assembly, remove the belt tensioning screw
- ◆ Loosen the three screws holding the motor on the front.
- ⓘ We need to release the belt tension, in order to release the belt in the upcoming step.

## STEP 33 X Belt Release

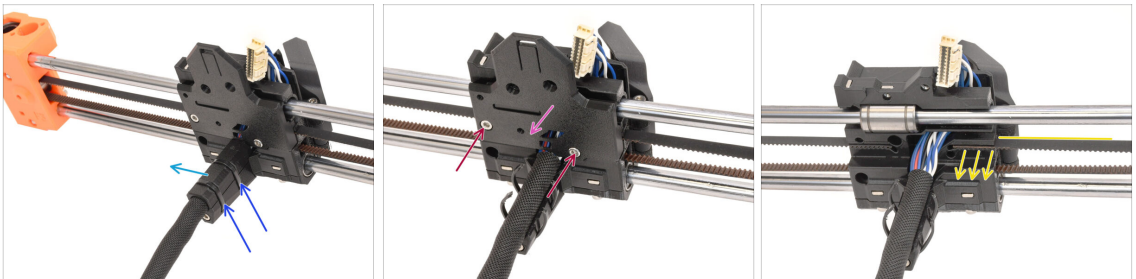

- ◆ On the back of the assembly, cut both the zip-ties holding the cable cover.
- ◆ Remove the cable cover.
- ◆ Remove both screws on the back of the X-carriage.
- ◆ Remove the cover on the back of the X-carriage.
- ◆ Pull out the end of the belt on the motor side, to disengage it.

## STEP 34 X Motor Removal



- ◆ Remove the three screws holding the X-motor at the front of the assembly.
- ◆ Remove the X-Axis motor and **save it for later use**.

## STEP 35 X Idler Shaft Removal

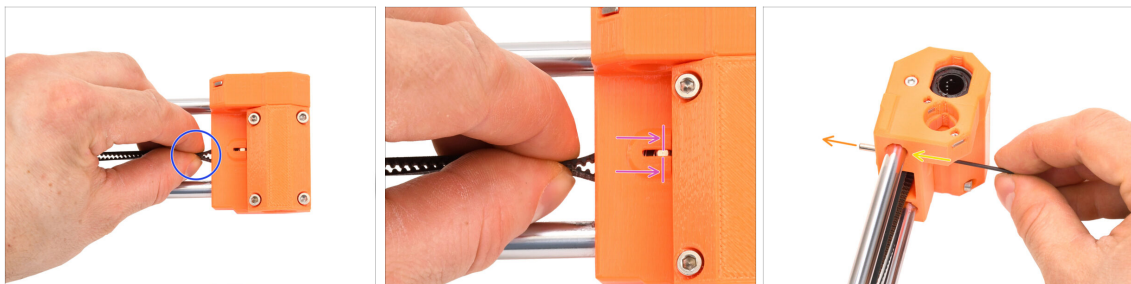

- ◆ Let's move onto the right X-end part.
- ◆ Use the belt as a handle for the Idler pulley inside the plastic part.
- ◆ Move the Idler **all the way inward**.

On the front, there is a small window where you can observe the idler shaft movement.

- ◆ While keeping the idler pushed all the way in, use the thinnest 1.5mm Allen key to push the shaft out of the part.
- ◆ The Idler shaft should exit the plastic part at the back. Remove it.

### STEP 36 X Idler Removal



- Pull out the Idler pulley.
- Save the pulley for later use.

### STEP 37 xBuddy Removal

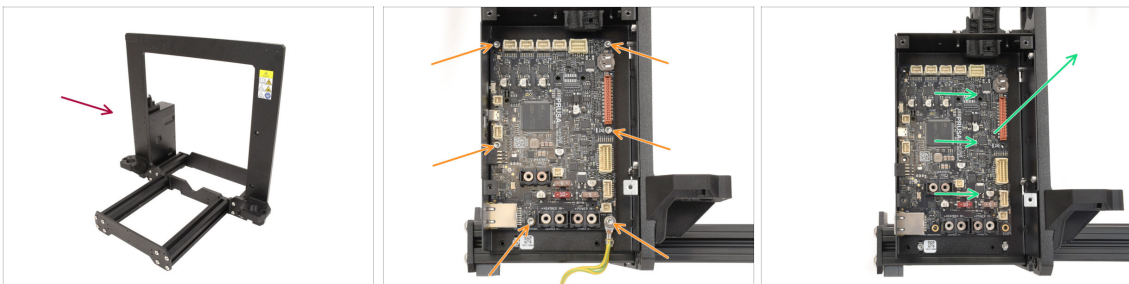

- Let's move back to the printer's frame.
- Remove the six screws holding the xBuddy board in place.
- Release the xBuddy by sliding it towards the frame, then lifting it. **Save it for later use.**



## STEP 1 xBuddy Prep

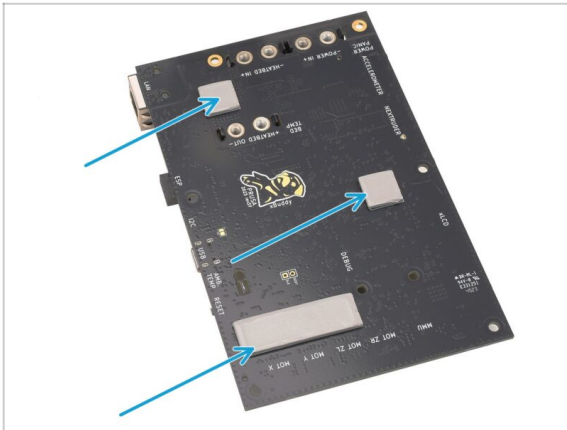

- ◆ There might be thermal pads stuck to the rear of the xBuddy board. Remove the thermal pads and clean up any glue residue.
- ⓘ Do not use sharp object to remove the pads.

## STEP 2 xLCD Disassembly



- ◆ Take the xLCD assembly.
- ◆ Remove the encoder knob and **save it for later use**.
- ◆ Flip the assembly around.
- ◆ Using the T10 Torx screwdriver, remove the screw holding the grounding faston connector.
- ◆ Remove the grounding faston connector and **save it for later use**.

### STEP 3 xLCD Disassembly 2



- ◆ Remove the three screws holding the assembly together.
- ◆ Separate the assembly from the front part of the cover.
- ◆ Remove the xLCD from the back of the cover. **Save it for later use.**

### STEP 4 Print Fan Prep



- ◆ Take the print fan assembly.
- ◆ Using the T10 screwdriver, remove the screw holding the fan shroud.
- ◆ Remove the fan shroud.
- ◆ Remove the two screws holding the cover and open the cover.
- ◆ Remove the fan from the plastic part. **Save the fan alone for later use.**

## STEP 5 Y Motor Prep

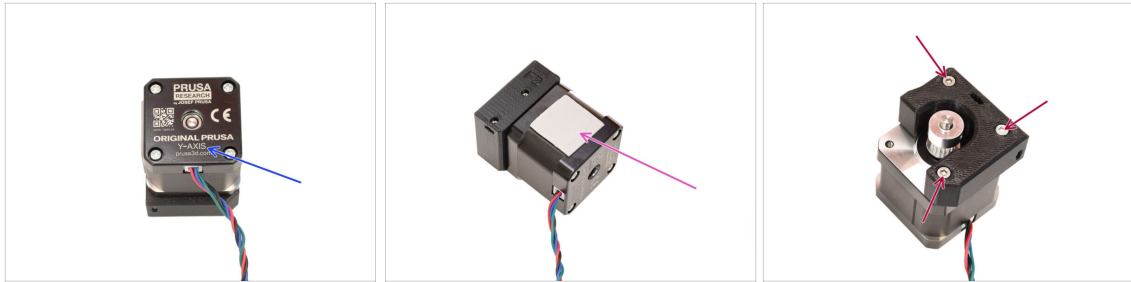

- ◆ Take the Y-Axis motor.
- ◆ Remove the thermal pad and any of its remaining pieces. Clean off any residue.
- ◆ Remove the three screws securing the motor to the plastic holder. Then, separate the motor from the holder.

## STEP 6 Y Motor Prep 2

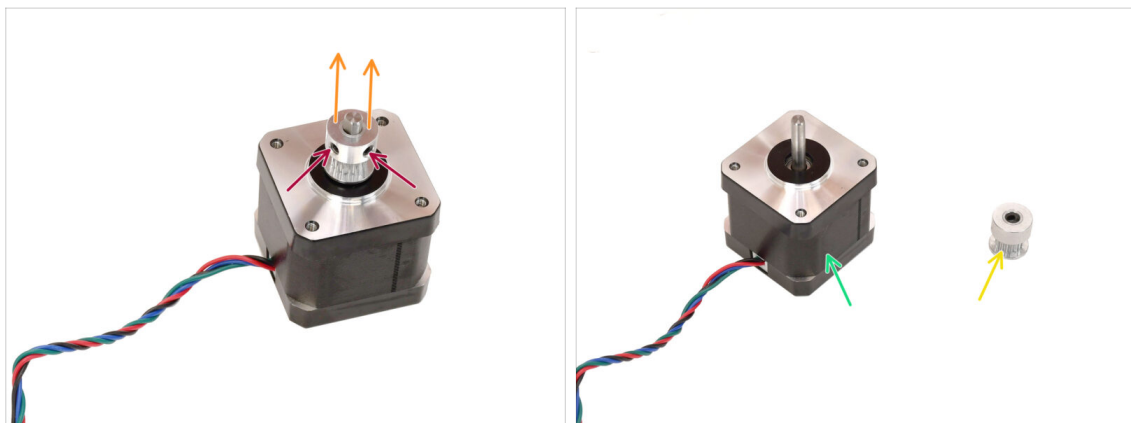

- ◆ Using the 2mm Allen key, loosen the two grub screws on the pulley. Do not remove them entirely.
- ◆ Separate the pulley from the motor.
- ◆ **Save the motor for later use.**
- ◆ **Save the pulley for later use.**

## STEP 7 X Motor Prep

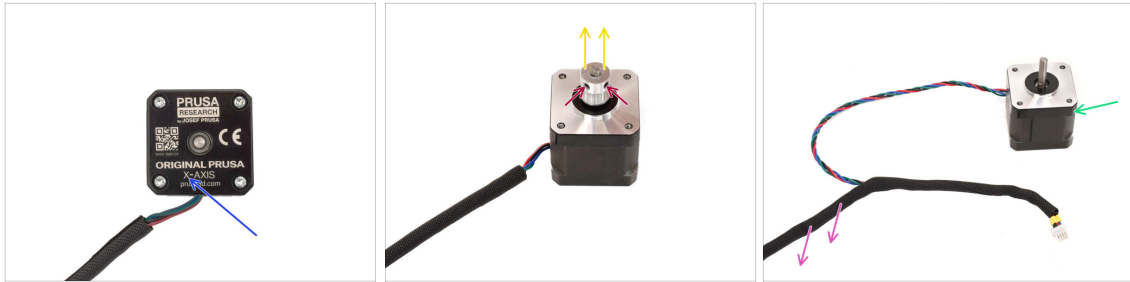

- ◆ Take the X-Axis motor.
- ◆ Loosen the two grub screws on the pulley but do not remove them entirely.
- ◆ Remove the pulley from the motor and **save it for later use**.
- ◆ Remove the textile wrap from the motor cable.
- ◆ **Save the motor for later use.**

## STEP 8 Z Motor Prep

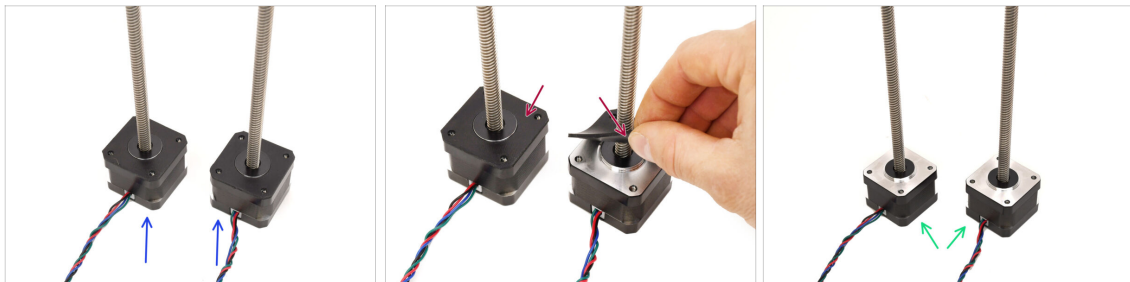

- ◆ Take the Z-Axis motors.
- ◆ Remove the rubber pads from both motors.
  - ◆ Clean off any residue from the pads.
- ◆ Save the motors for later use.

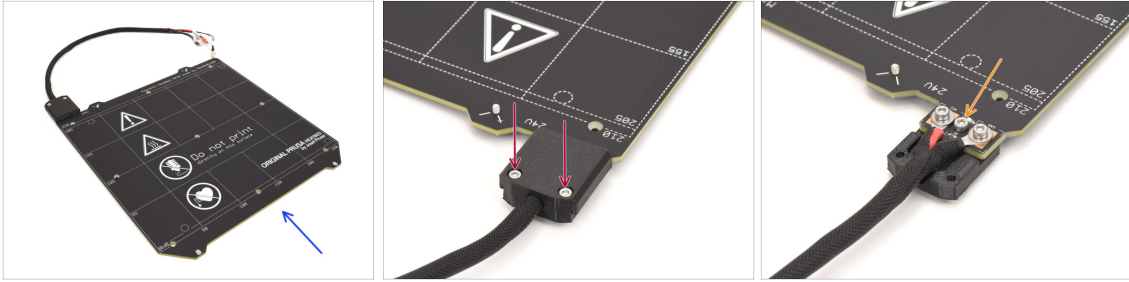
**STEP 9** Heatbed Prep

- ◆ Take the MK4S Heatbed assembly.
- ◆ Remove the two screws holding the cable cover and remove the top part of the cover.
- ◆ Remove the marked screw in the middle and detach the bottom part of the cover from the heatbed.

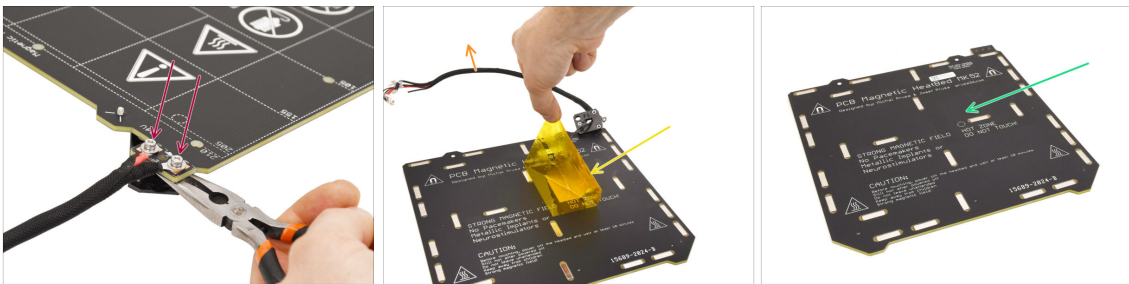
**STEP 10** Heatbed Prep 2

- ◆ Remove the two screws holding the power cables.
  - ⓘ Note that there are M3nN nuts underneath that must be held using either the Unikey or needle-nose pliers to remove the screws on top.
- ◆ Remove both the Kapton and aluminum stickers on the underneath to detach the thermistor.
- ◆ Remove the whole cable bundle together with the thermistor.
- ◆ Clean up any leftover adhesive and **save the heatbed alone for later use.**

## STEP 11 Thermistor Prep

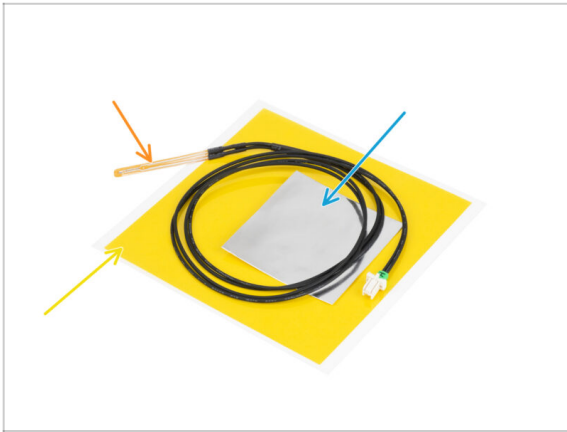

- ◆ For the following steps, please prepare:
- ◆ CORE One Heatbed thermistor (1x)
  - ⓘ This thermistor has a longer cable compared to the MK4/S version.
  - 📌 The new thermistor comes in a separate bag within the main package.
- ◆ Kapton tape (1x)
- ◆ Aluminum tape (1x)

## STEP 12 Thermistor Installation



- ◆ Place the thermistor onto the heatbed, ensuring the tip is positioned inside the circle.
  - ⚠ Important: If the thermistor is misaligned, the printer will read incorrect temperature values.
  - ⚠ Also, note which side the sensor is attached to on the heatbed.
- ◆ Use the aluminum tape to fix the thermistor in place.
  - 📌 The thermistor cable should be directed toward the power connector area.
  - ◆ Keep the tip of the thermistor in the circled area, while applying the tape.

## STEP 13 Thermistor Installation 2

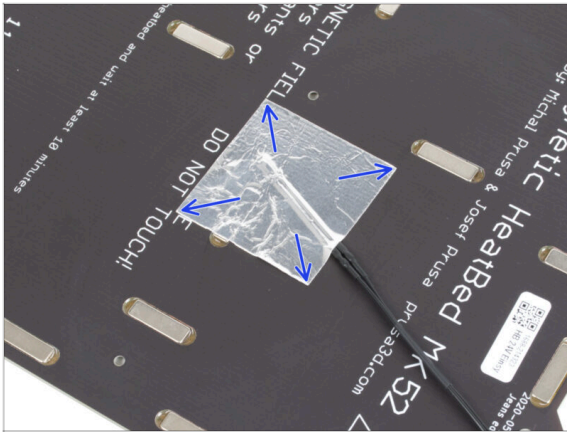

- Smooth out the aluminum tape around the thermistor using your fingers only, to ensure it is fully adhered.

## STEP 14 Thermistor Installation 3

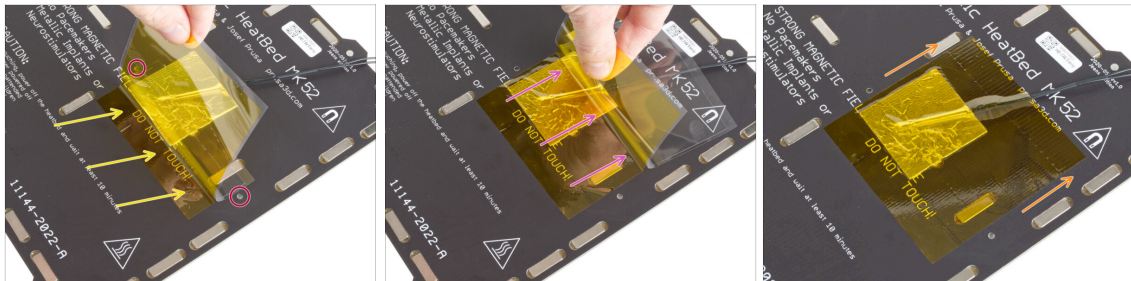

- Now, it is time to apply the final yellow Kapton tape.

**DO NOT peel off the entire tape at once—it will curl up!**

- Peel off about 1 cm (1/2 inch) strip of the Kapton tape and stick it to the heatedbed.
- Start applying the tape so that it overlaps the aluminum foil entirely, while making sure it **does not obstruct any screw holes in the heatedbed.**
- Continue applying the tape gradually, ensuring it does not curl too much.
- Finally, Check that the entire surface has adhered properly.

## STEP 15 Heatbed Rework

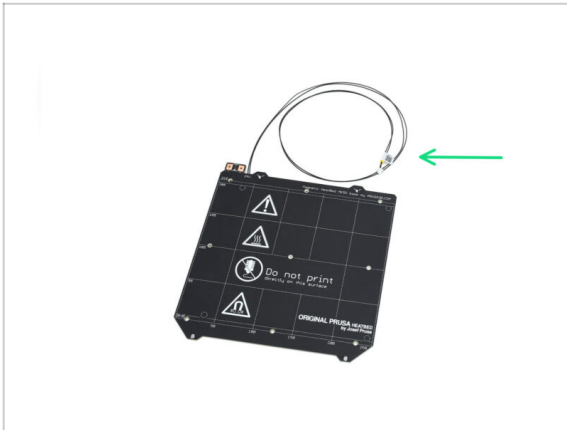

- ◆ You have successfully reworked the heatbed into the CORE One version. **Save it for later use.**

## STEP 16 Gearbox Cover Preparation



- ◆ **For the following steps, prepare:**
- ◆ Gearbox Cover CORE One (1x)
- ⓘ From the Printed Parts box.

## STEP 17 Nextruder Rework



- ◆ Take the Nextruder assembly.
- ◆ Open the Idler.
- ◆ Loosen the three screws on the gearbox but do not remove them yet.
- ◆ Carefully remove the screws while holding the assembly together to prevent it from coming apart.
- ◆ Remove the cover, while keeping the rest of the gearbox together.

## STEP 18 Nextruder Rework 2



- ◆ Apply more grease between the gears if your gearbox lacks lubrication.  
If there is already sufficient lubricant, you can leave it as is.
- ◆ Install the CORE One gearbox cover.
- ◆ Fix the assembly together using the three M3x25 screws you have removed earlier.
- ◆ **Save the reworked Nextruder for later use.**

## STEP 19 Bearings Check



- ◆ Earlier, you have removed at least three LM8UU bearings from your printer.
- 📌 Only two of this type of bearings will be used to build the CORE One.
- Check each bearing for seamless movement by attaching it to a smooth rod and sliding it back and forth.
  - Select two of the best-performing bearings for later use.
  - ◆ Set aside the remaining bearing(s).

## STEP 20 Parts Check

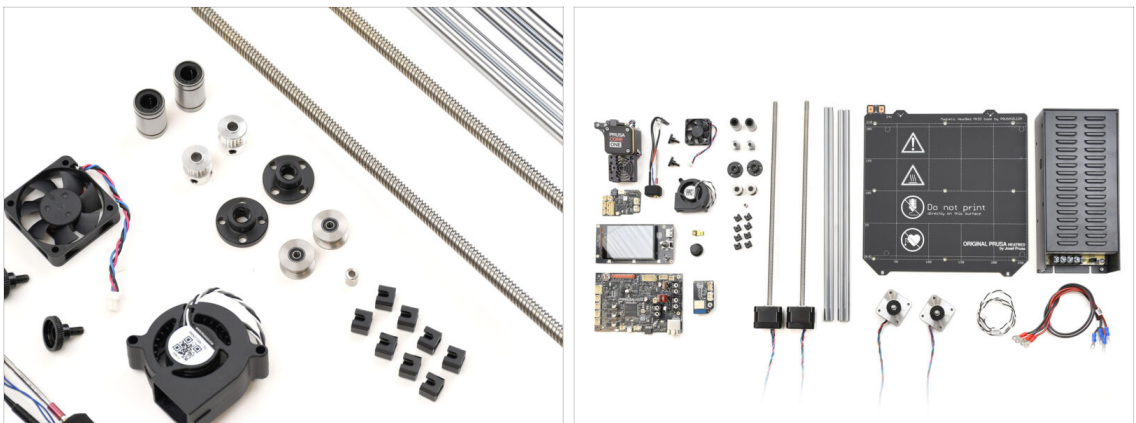

- ◆ The disassembly and preparation part is over.
- ⚠ In the following steps, **we will list the required parts one by one**. Check that you have everything listed.

## STEP 21 Parts Recap 1



- LM8UU Bearing (2x)
- GT2-16 Pulley (2x)
- Trapezoid Nut (2x)
- Idler Pulley (2x)
- Heatbed Spacer
- Expansion Joint (8x)

## STEP 22 Parts Recap 2

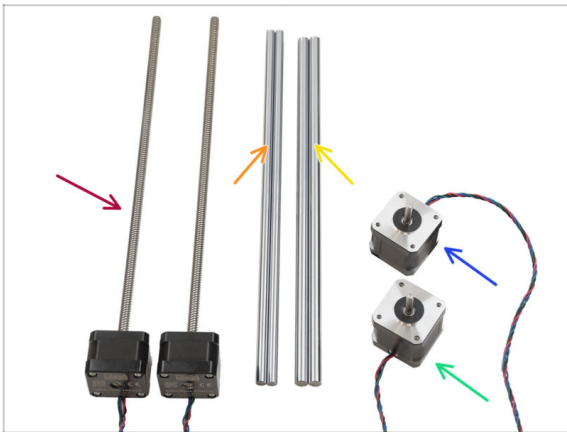

- Z-motor (2x)
- Rod 8x330 (2x)
- Rod 10x325 (2x)
- Y-Motor
- X-Motor

### STEP 23 Parts Recap 3

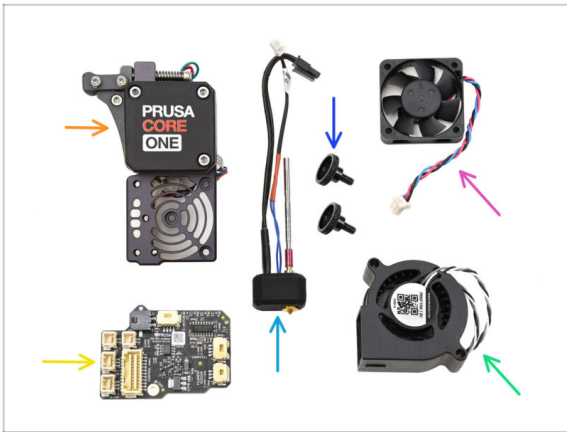

- Nexttruder Assembly
- Nozzle Assembly
- Thumb Screw (2x)
- Hotend Fan
- LoveBoard
- Print Fan

### STEP 24 Parts Recap 4

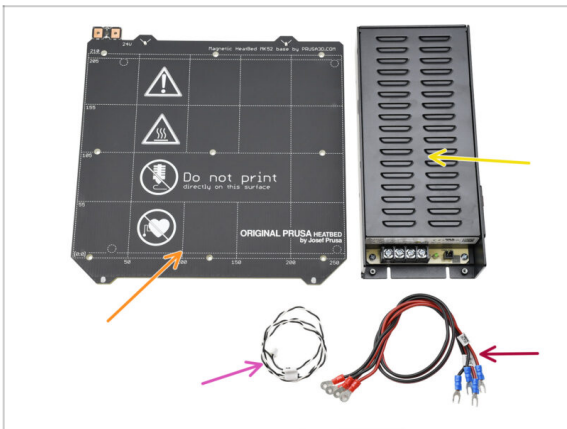

- Heatbed
- PSU
- Power Panic Cable
- PSU Power Cable (2x)



## 2. Base assembly



## STEP 1 Tools necessary for this chapter

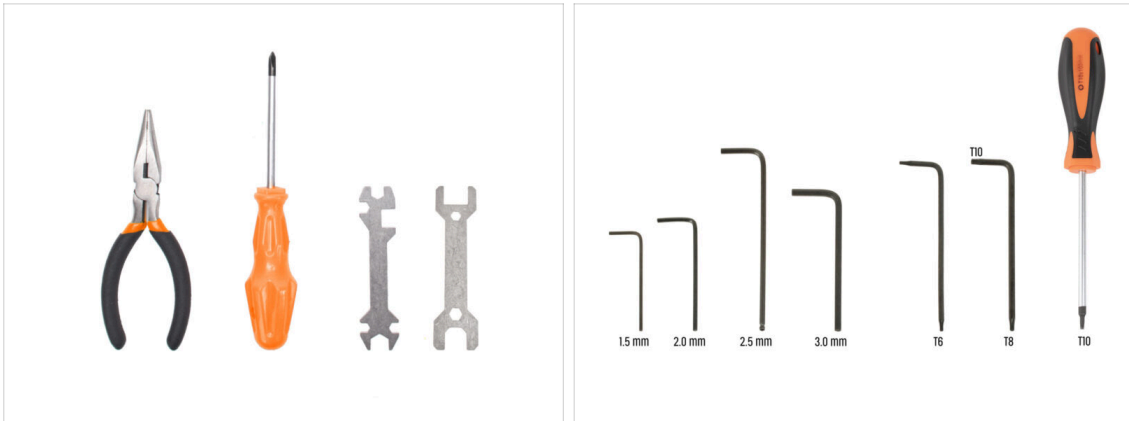

● For this chapter, please prepare:

- Wrench 13-16
- 2.5mm Allen key
- T10 torx key / T10 torx screwdriver

## STEP 2 Base assembly: parts preparation

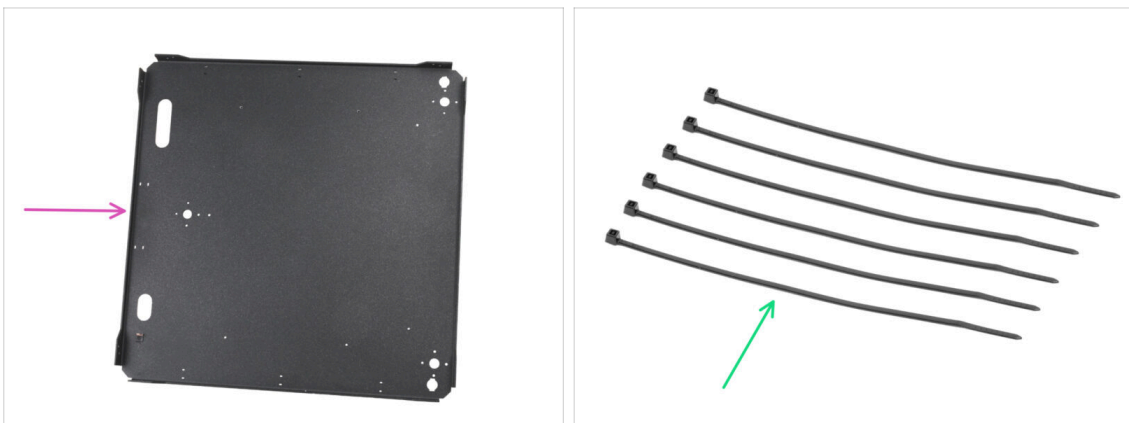

● For the following steps, please prepare:

- Bottom panel (1x) found in the Metal parts 1/3 package
- Zip tie (6x) found in the Electronics & Fasteners package

### STEP 3 Inserting the zip ties

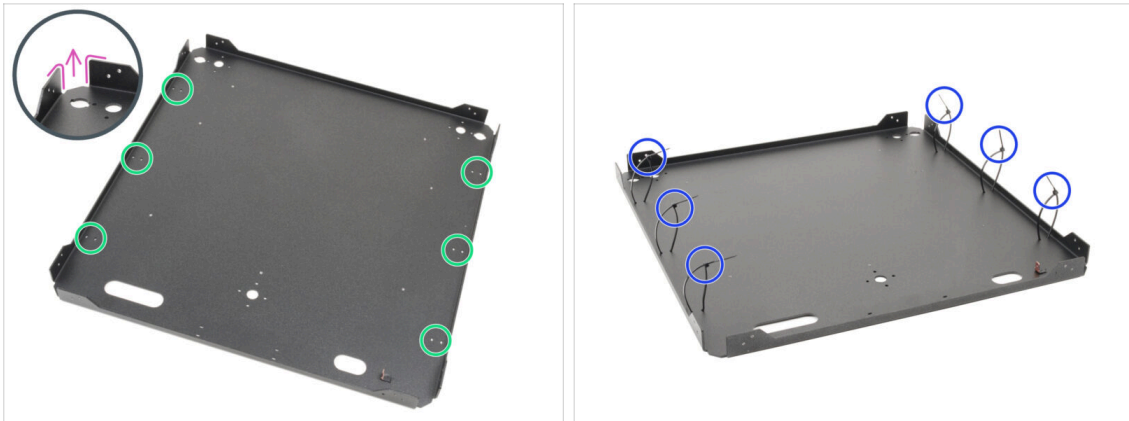

- ◆ Turn the bottom panel so that the bends of the plate are facing upwards.
- ◆ Note the twin holes for the zip ties around the perimeter of the panel.
- ◆ Insert six zip ties through the holes, placing them along both sides and partially tightening them, engaging only the first few teeth.
- ⚠ **Do not fully secure them yet, as we will route cables through them later.**
- ⓘ Note: The orientation of the zip tie heads (inside or outside the metal sheet) doesn't matter.

### STEP 4 Base assembly: parts preparation (Part 1)

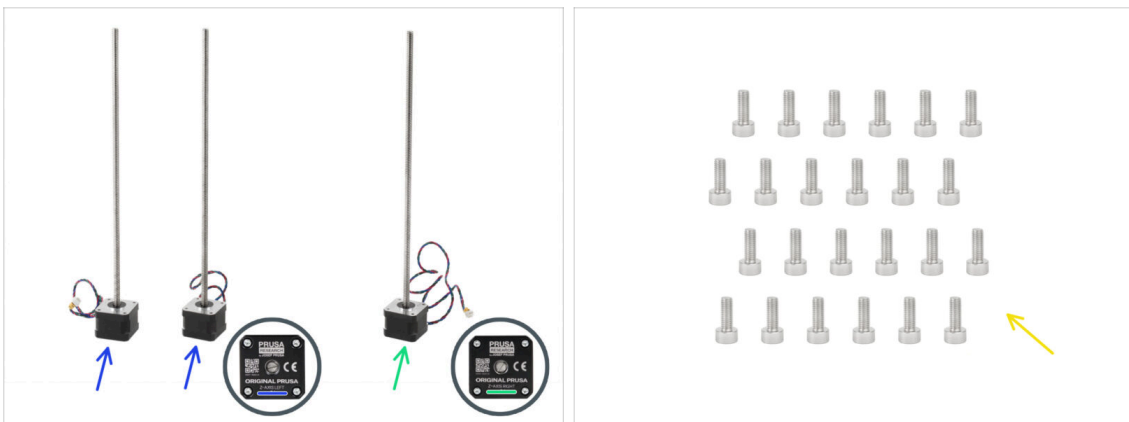

- ◆ **For the following steps, please prepare:**
- ◆ Z-axis left motor (2x)
  - 📌 One of these motors is in the electronics & chamber parts box.
- ◆ Z-axis right motor (1x)
- ◆ M3x8 screw (24x) *found in the Electronics & Fasteners package.*

## STEP 5 Base assembly: parts preparation (Part 2)

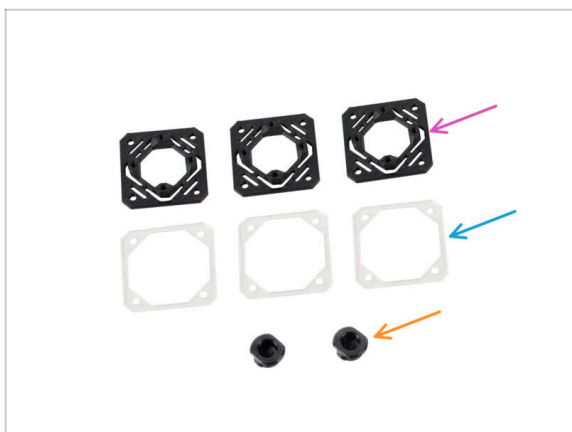

◆ Z-motor-mount (3x) found in the Printed parts package

◆ Motor washer (3x) found in the Electronics & Chamber parts package

◆ Z-rod-mount (2x) found in the Printed parts package

ⓘ **Important:** If the Motor washers are not included in your package, your kit contains the new version of the Z-motor-mount, which does not require Motor washers.

◆ The new version of the Z-motor-mount was released in 05/2026.

## STEP 6 Installing the motor mounts

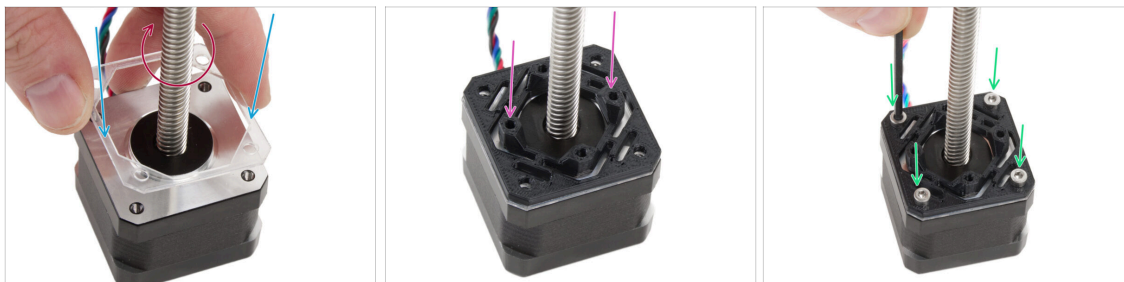

◆ Try to rotate the threaded rods on each Z motor to make sure they are not completely blocked in rotation.

◆ Attach one transparent motor washer pad on each Z motor.

◆ Place one Z-motor-mount on each motor washer. **The protrusions on the part must be facing upwards.**

◆ Align holes with all the parts.

◆ Join all parts together with four M3x8 screws.

◆ Follow the same procedure for all motors.

## STEP 7 Installing the rear motor

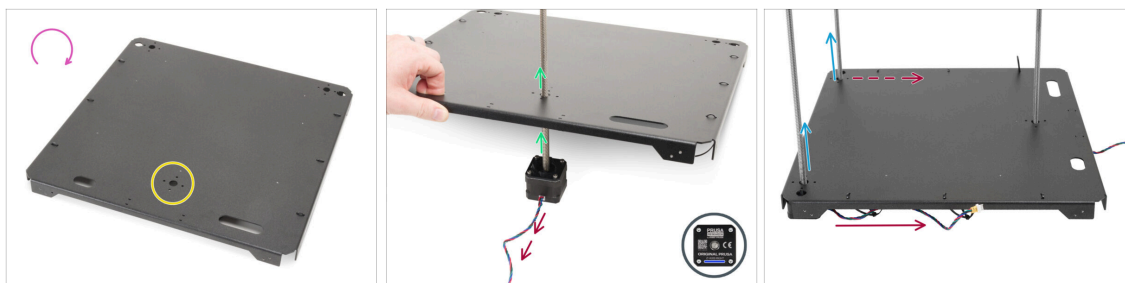

- ✿ Turn the bottom panel upside down.
- Locate the circle hole in the middle of the panel back side.
- Take the **Z motor right** - the motor with the longest cable. Labeled ZR on the cable.
- Push the motor threaded rod through the panel and align the holes in the panel with the holes in the motor assembly.
- ⚠ **The motor cable must point outwards (towards you).**
- Push both Z-axis motor left through the bottom panel.
- **The motor cables must point to the rear motor side.**
- ⓘ In the following instructions, we will refer to the **front** and **rear** sides of the assembly. The **front side has TWO motors**, while the **rear side has ONE motor**. We will remind you along the way, but it's good to keep this in mind :).

## STEP 8 Securing the rear motor

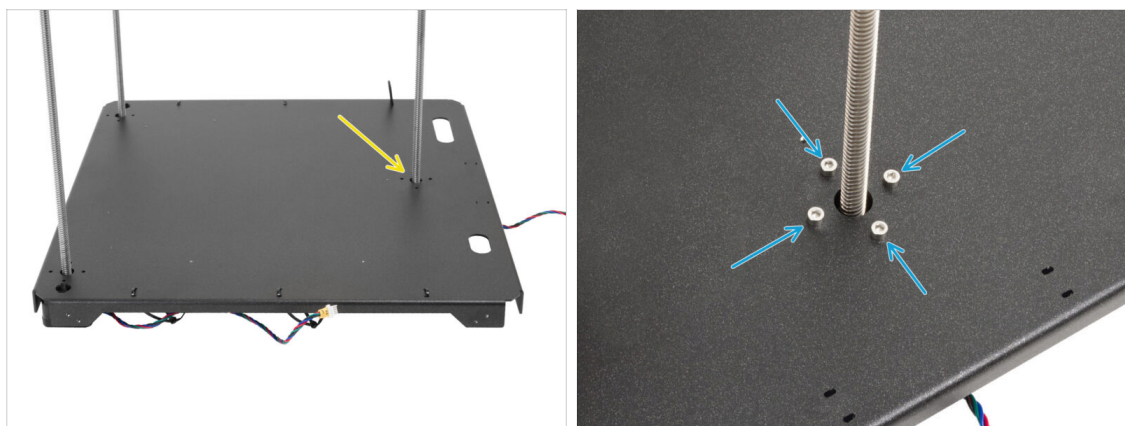

- Begin securing the motors, starting from the rear motor.
- Insert and fully tighten four M3x8 screws into the **rear motor**.
- ⚠ **Make sure the screws stay straight and do not tilt as you tighten them.**
- ⚠ **Do not overtighten the screws, as they thread directly into the plastic part. For a final tightening, use the shorter part of the key as a handle to apply the correct amount of torque.**

## STEP 9 Installing the front motor right

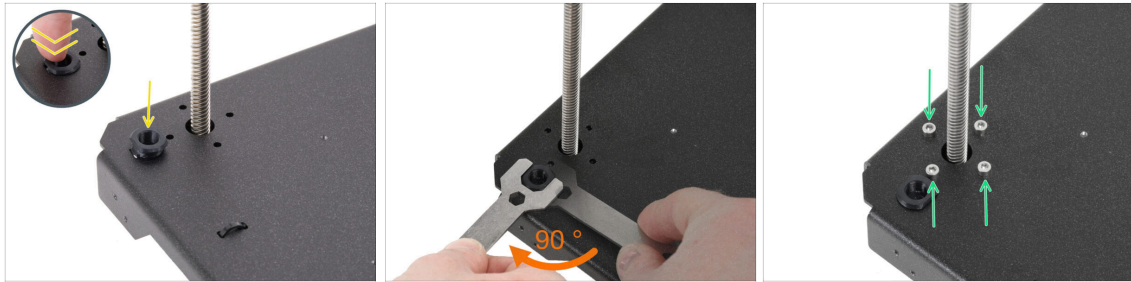

- ◆ First, insert the rod-mount into the opening next to the front right Z motor.
- ◆ Use the 13-16 wrench to rotate the rod mount 90 degrees, locking it into place.
- ◆ Secure the motor using four M3x8 screws. Tighten them completely.  
⚠ Make sure the screws stay straight and do not tilt as you tighten them.

## STEP 10 Installing the front motor left

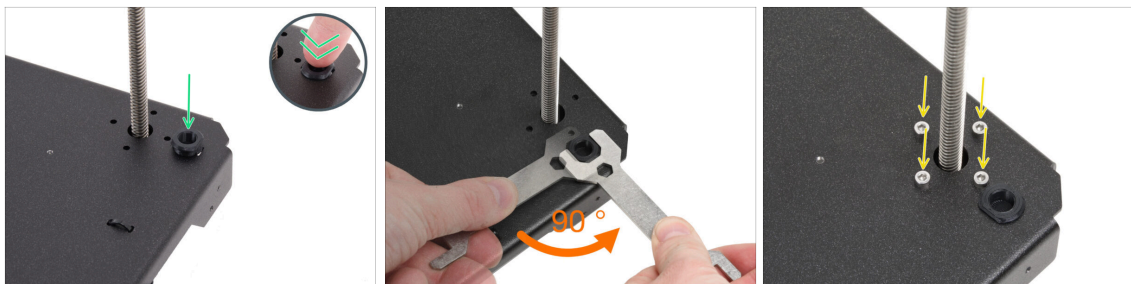

- ◆ Let's move to the front left motor (from the front view).
- ⚠ Ensure, the motor cable still points to the rear side.
- ◆ Insert the rod-mount into the opening next to the front right Z motor.
- ◆ Use the 13-16 wrench to rotate the rod mount 90 degrees, locking it into place.
- ◆ Secure the motor using four M3x8 screws. Tighten them completely.  
⚠ Make sure the screws stay straight and do not tilt as you tighten them.
- ◆ Place the whole assembly aside for a while.

**STEP 11** Bottom frame: parts preparation

◆ For the following steps, please prepare:

⚠ **Be very careful when handling sharp sheet metal parts to avoid injury or damage.**

⚠ Metal sheet profiles may look identical at first glance, but there are some differences. **DOUBLE-CHECK** to pick the correct ones.

- ◆ Front profile (1x) **notice the cutouts** - found in the Metal parts 1/3 package
- ◆ Rear profile (1x) **with two holes on the flat side** - found in the Metal parts 1/3 package
- ◆ Universal profile (2x) **no holes on the flat side** - found in the Metal parts 1/3 package
- ◆ Spacer pin (2x) found in the Electronics & Fasteners package
- ◆ M3x4rT screw (4x)

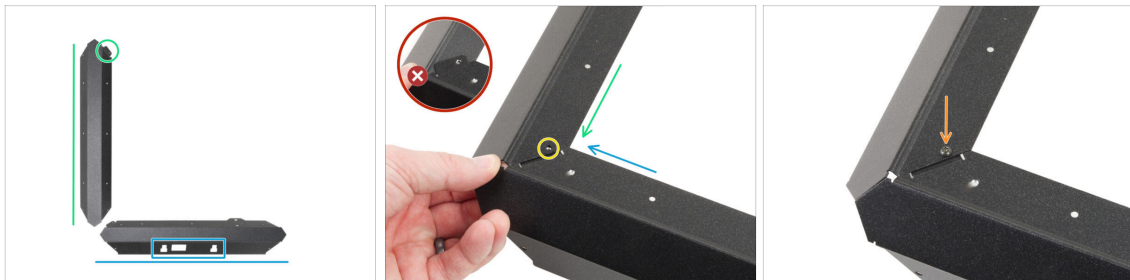
**STEP 12** Assembling the bottom profile: front + left

⚠ **Be very careful when handling sharp sheet metal parts to avoid injury or damage.**

- ◆ Place the front profile according to the picture. The cutouts must be facing you.
- ◆ Place one of the universal profiles on the left side. Orient the part according to the picture. **Use the flange as a guide.**
- ◆ Attach the two profiles together.
  - ⚠ **The flange of the front plate (blue arrow) must be inserted **under** the left universal profile (green arrow), not on top of it.**
- ◆ Align the holes in both parts.
- ◆ Join both parts together with the M3x4rT screw.

### STEP 13 Assembling the bottom profile: left + rear

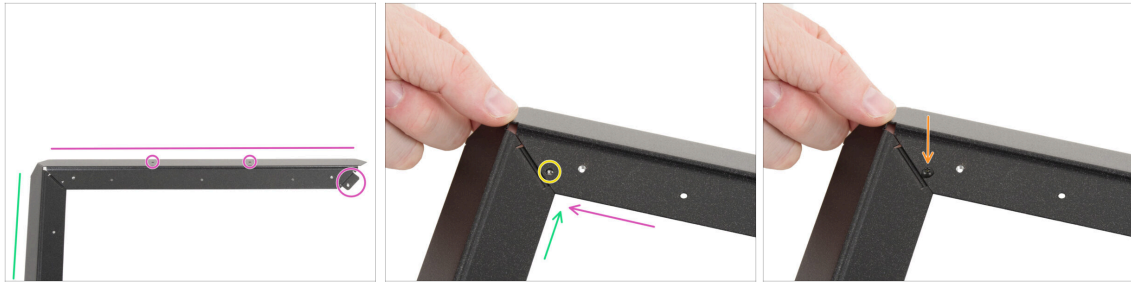

- According to the picture, place the rear profile (with two holes on the flat side) to the universal left profile. Orient the part according to the picture. **Use the flange as a guide.**
- Join the rear profile with the universal left profile together.
  - ⚠ **Make sure the flange is under the rear profile, not on top.**
- Align the holes in both parts.
- Join both parts together with the M3x4rT screw.

### STEP 14 Assembling the bottom profile: right



- Attach the universal right profile between the rear and front profile. **Ensure that:**
  - The **rear** end is **above** the rear profile flange.
  - The **front** flange is inserted **under** the front profile.
- Secure the left profile with M3x4rT on both ends.

### STEP 15 Inserting the spacer pins



- ◆ Insert the spacer pin into the hole in the front profile protrusion.
- ◆ Push firmly on the spacer pin so that it fits perfectly into the hole.
- ◆ Use the same procedure for the second spacer pin.

### STEP 16 Anti-vibration feet: parts preparation



- ◆ **For the following steps, please prepare:**
- ◆ Anti-vibration foot (4x) found in the *Electronics & Chamber parts package*
- ◆ M3x4rT screw (8x)

## STEP 17 Installing the anti-vibration feet



- Place the bottom frame according to the picture. The front profile must be facing you.

 Before applying the anti-vibration feet, **wipe the metal profiles with isopropyl alcohol** and let them dry. This ensures proper adhesion.

- Peel off the protective layer from all anti-vibration feet.

 **Carefully peel off only the protective film from each anti-vibration foot. If the adhesive layer starts to come off with the film, stop and peel from a different corner.**

- Stick one anti-vibration foot in each corner of the frame. Align it with the outer edge of the flat side of the profile.

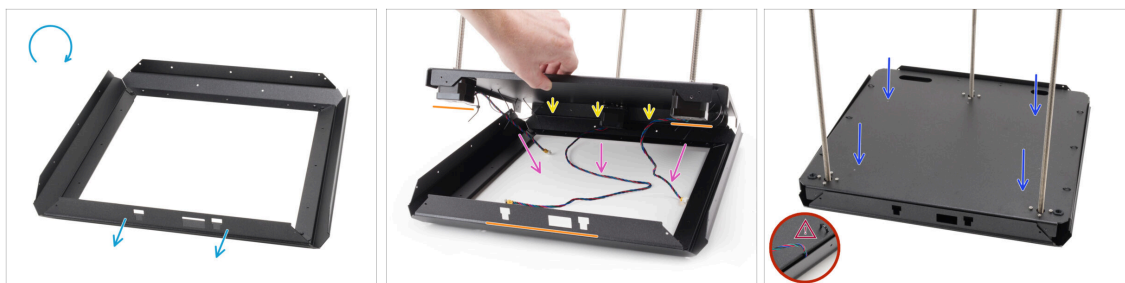
**STEP 18** Installing the bottom frame

- Turn the bottom frame upside down. **The front profile must be facing you.**
  - Attach the rear side of the bottom panel assembly to the rear side of the bottom frame.
    - Ensure that the front side of the bottom panel assembly (with two motors) aligns with the front profile of the bottom frame (with cutouts).
  - Place all the motor cables inside the center area of the bottom frame to prevent pinching.
  - Slowly and carefully lower the bottom panel assembly into the bottom profile.
    - Ensure the assembly fits completely **inside the bottom profile.**
    - Make sure no part of the bottom panel assembly extends outside the bottom frame
- ⚠ Double-check that no cables are pinched.**

**STEP 19** Mounting the bottom frame: right side

- Focus on the front right corner and right side.
- Slightly lift one of the corners of the bottom panel assembly.
- Align the threaded hole in the bottom panel with the hole in the profile.
- Join both parts together with the M3x4rT screw.
- Move to the rear corner of the right side.
- Align the holes in the base and the profile and secure it with the M3x4rT screw.

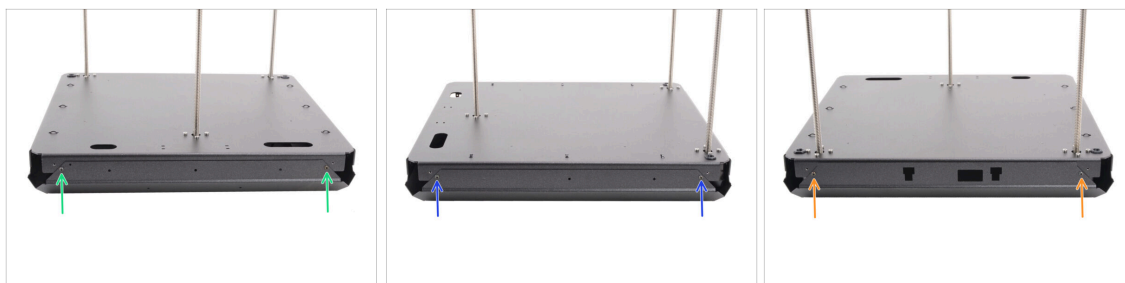
**STEP 20** Mounting the bottom frame: rear + left + front

- Move to the rear side of the assembly (side with one Z motor).
- Align holes in the base assembly and the profile and secure it with two M3x4rT screws.
- Focus on the left side of the assembly.
- Align holes in the base assembly and the profile and secure it with two M3x4rT screws.
- Turn the assembly with the front profile facing you (profile with cutouts).
- Align holes in the base assembly with the profile and secure them using two M3x4rT screws.

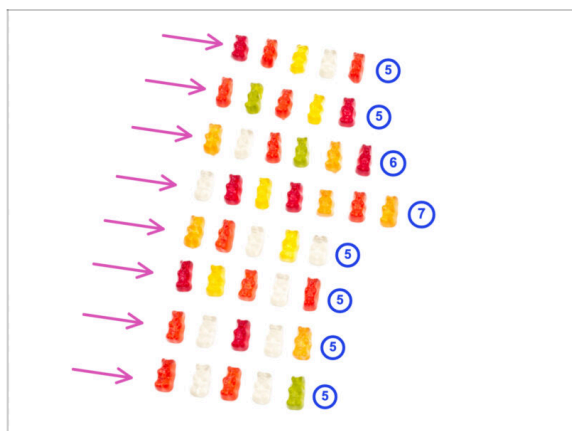
**STEP 21** Haribo time

- It's time to reward yourself!
- Stack your gummy bears in eight rows.
- Arrange the number of gummy bears in each row as shown in the picture.
  - ⓘ If you don't get the exact number in the last row, we recommend finding the nearest candy store and buying the missing ones.
- Eat the first row.

**STEP 22** Done



- ◆ **Congratulations!** You just assembled the **base assembly**.
- ◆ Set the assembly aside for now and let's move to the next chapter.

### 3. Back assembly



## STEP 1 Tools necessary for this chapter

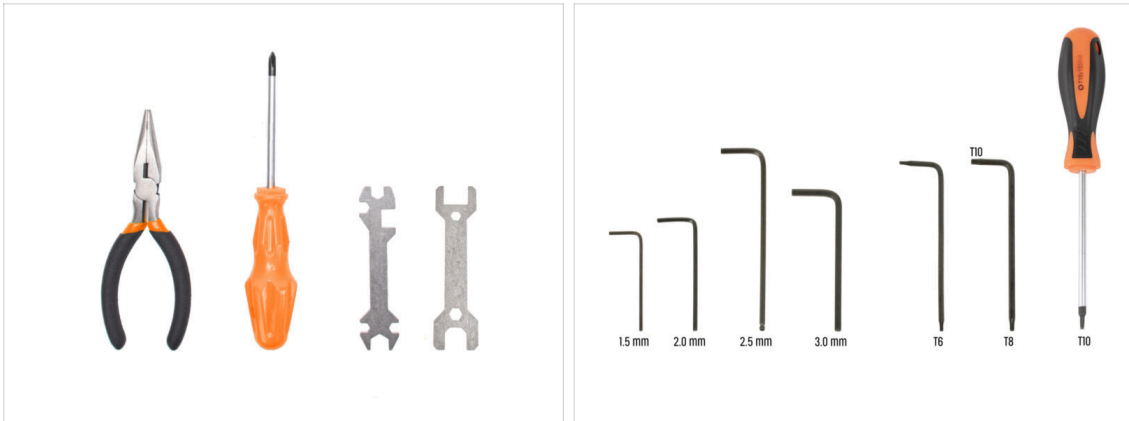

- For this chapter, please prepare:
- Philips (PH2) screwdriver
- Needle-nose pliers
- 2.5mm Allen key
- T10 torx key / T10 torx screwdriver

## STEP 2 xBuddy: parts preparation I.

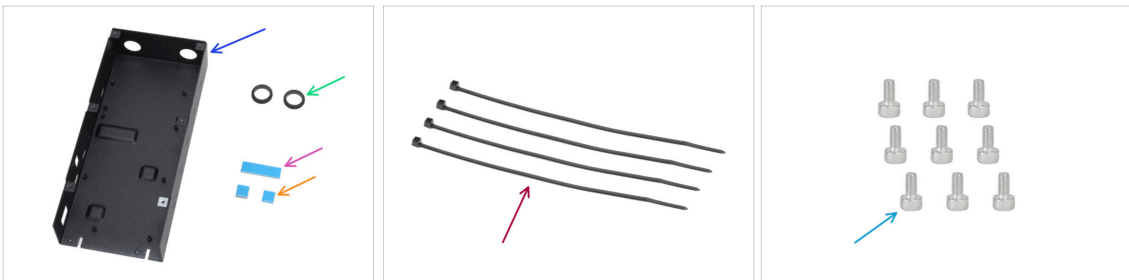

- For the following steps, please prepare:
- CORE One xBuddy box (1x) found in the Metal parts 3/3 package
- Grommet 19/16 mm (2x) found in the Electronics & Fasteners package
- Thermal pad 40x12x2.2 mm (1x) found in the Electronics & Fasteners package
- Thermal pad 12x12x2.2 mm (2x) found in the Electronics & Fasteners package
- Zip tie (4x)
- M3x6 screw (9x)
- **i** The list continues in the next step...

### STEP 3 xBuddy: parts preparation II.

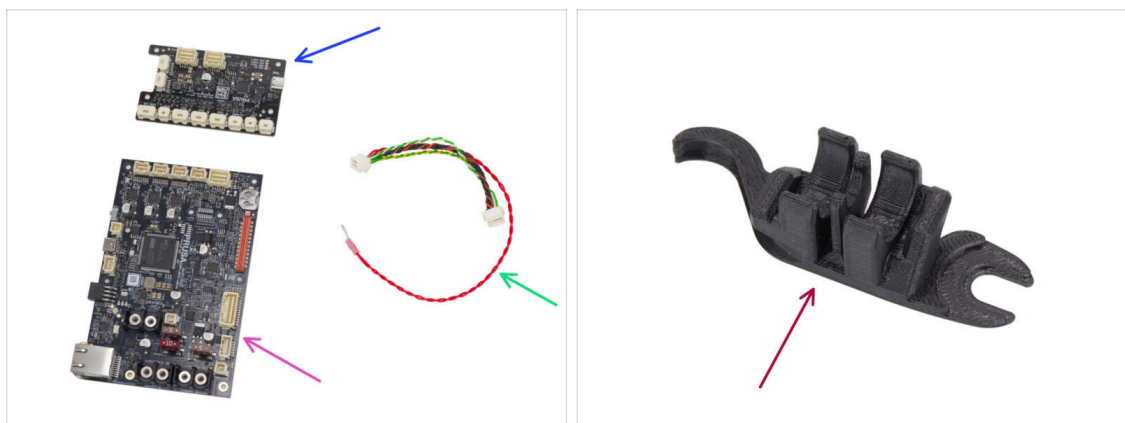

- ◆ xBuddy extension board (1x) *found in the Electronics & chamber package*
- ◆ xBuddy board (1x)
- ◆ xBuddy extension cable (1x) *found in the Electronics & Fasteners package*
- ◆ Assembly-multi-tool (1x) *found in the Printed parts package*

### STEP 4 Applying the thermal pads

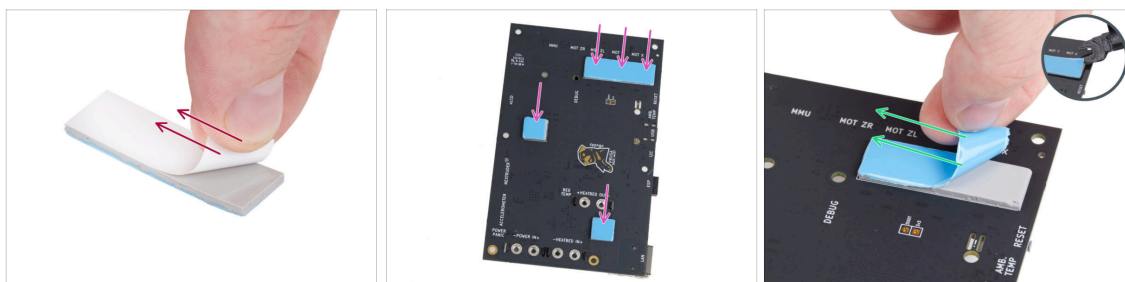

- ◆ Peel off the white protective layer from all thermal pads.
  - ⚠ **Always touch the sides of the electronics board while manipulating it. Avoid touching the chips, capacitors and other parts of the electronics.**
- ◆ Attach the pads onto the back of the xBuddy board. There are markings that indicate the correct size and positions.
  - ⓘ Ensure the pad attachment surface is clean and degreased.
- ⚠ **For the protection of the board's electronic components, we strongly recommend placing the xBuddy board on the soft pad. You can use the original xBuddy bubble wrap package.**
- ◆ Peel off the blue protective layer from all thermal pads.
  - ⓘ Pro tip: If the edge of the layer is difficult to lift, you can use the thin side of the Assembly-multi-tool to help separate the protective layer.

## STEP 5 Installing the xBuddy

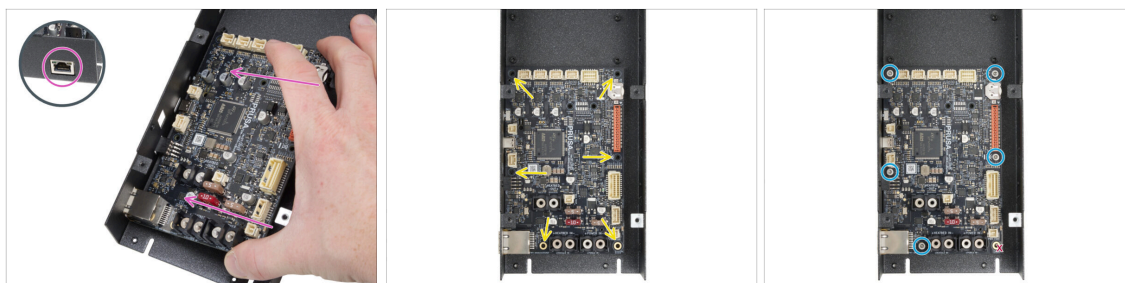

**⚠ Always touch the sides of the electronics board while manipulating it. Avoid touching the chips, capacitors and other parts of the electronics.**

- Insert the xBuddy board to the xBuddy box.
  - Make sure the Ethernet connector is properly inserted into the hole in the xBuddy box.
  - **Before fully securing**, align the board's holes with the xBuddy box's threaded standoffs.
  - Fix the position of the xBuddy board by inserting five M3x6 screws. Do not fully tighten the screws. A few turns are enough for now.
- ⚠ **Put aside your instinct and leave the hole on the bottom right empty.**
- **Fully tighten all five screws. But very carefully**, otherwise you can damage the electronics board.

## STEP 6 Installing the xBuddy extension

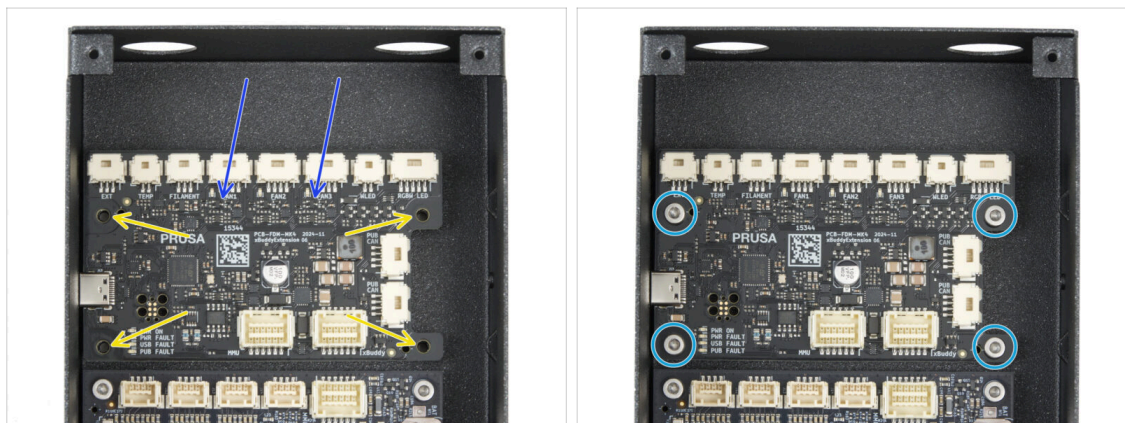

- Insert the xBuddy extension board to the xBuddy box above the xBuddy board. Notice the part orientation.
- Before fully attaching it completely, center the holes in the board with the holes (columns) in the xBuddy box.
- Fix the position of the xBuddy extension board by inserting four M3x6 screws. Tighten them completely.

## STEP 7 Installing zip ties



- ◆ Take a closer look at to the xBuddy box. There are six perforations on the metal case.
- ⚠ **Proceed very carefully. Be careful not to damage the connectors or capacitors on the xBuddy board.**
- ◆ Attach the hook on the Assembly-multi-tool below the first perforation on the left.
- ◆ Push the zip tie through the perforation and into the Assembly-multi-tool. It will guide the zip tie into the electronics box.
- ⚠ **Note the correct orientation of the zip tie. The teeth on the zip tie must be on the visible side.**
- ◆ Repeat the process at the indicated perforations.
  - ◆ Skip the third and sixth perforations.

## STEP 8 Connecting the xBuddy extension board

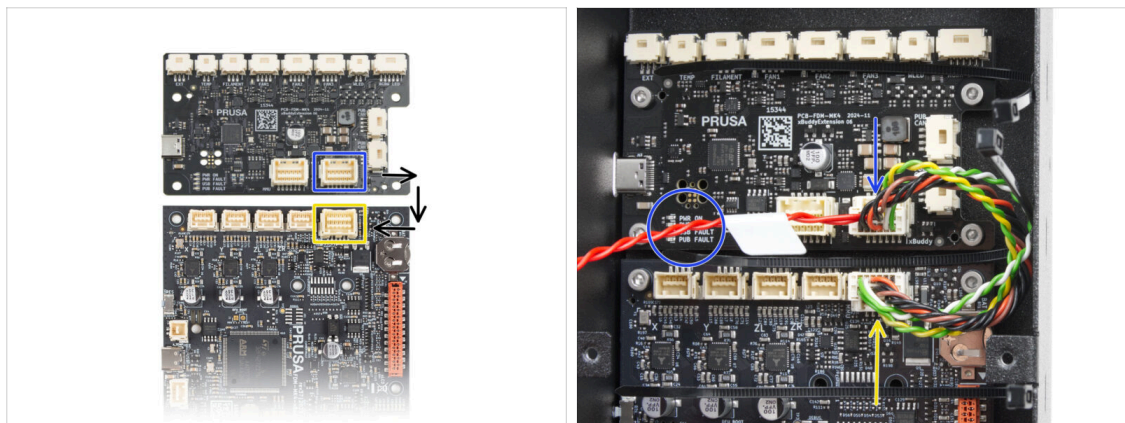

- ◆ Plug the xBuddy extension connector with the free red cable to the xBuddy extension board.
  - ◆ Leave the red cable free for now.
- ◆ Plug the other end of the xBuddy extension cable to the xBuddy board.

## STEP 9 Inserting grommets: xBuddy box



- Insert both grommets into both circle holes in the xBuddy box.
- Gently compress the grommet and fit it into the metal sheet, ensuring the groove locks into place

## STEP 10 Wi-Fi: parts preparation



- **For the following steps, please prepare:**
- ESP-WiFi (1x) *reused from the MK4S*
- CORE-One-Wifi-cover (1x) *found in the Printed parts package*
- M3x12 screw (1x)
- M3x6 screw (2x)

#### STEP 11 Assembling the Wi-Fi



- ✦ Insert two M3x6 screw to the xBuddy box assembly from the right side. **Do not tighten them completely.** Leave at least a 4 mm (0.16 in) gap.
- ✦ Insert the ESP-WiFi module into the WiFi-cover, positioning it just below the bridge on the left side.
- ✦ On the other side, ensure the connector fits correctly into the hole in the cover.

#### STEP 12 Installing the Wi-Fi assembly

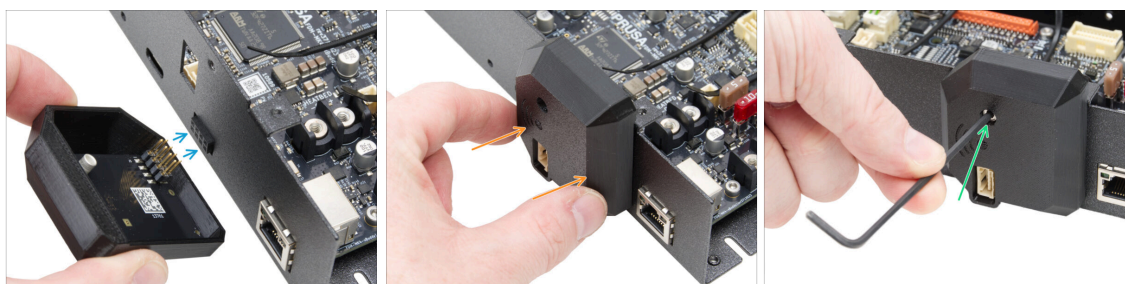

- ⚠ **Be very careful when handling and connecting the ESP module to avoid bending and damaging the pins.**
- ✦ Take the WiFi cover assembly and connect the ESP module pins to the connector in the xBuddy.
- ✦ Close the WiFi cover carefully, ensuring the pins of the ESP module are properly engaged in the connector on the xBuddy.
- ✦ Secure the cover with the M3x12 screw.
- ✦ Put the assembly aside for a while.

## STEP 13 PSU assembly: parts preparation

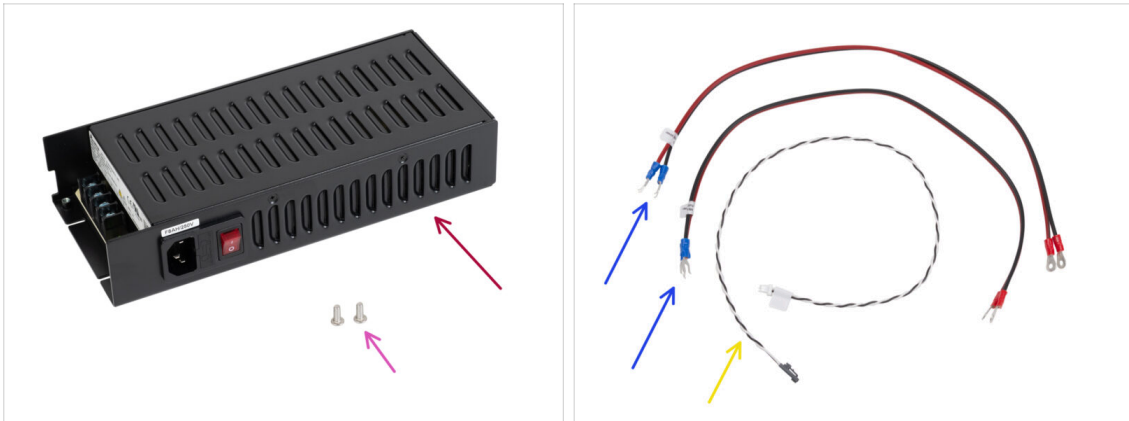

● For the following steps, please prepare:

● Delta PSU 240 W 24 V (1x) *power supply*

● M4x6r screw (2x)

● xBuddy power cables (2x)

● Power panic cable (1x)

ⓘ The power panic cable may look different, depending on your MK4S printer / xBuddy board version.

## STEP 14 Preparing the PSU

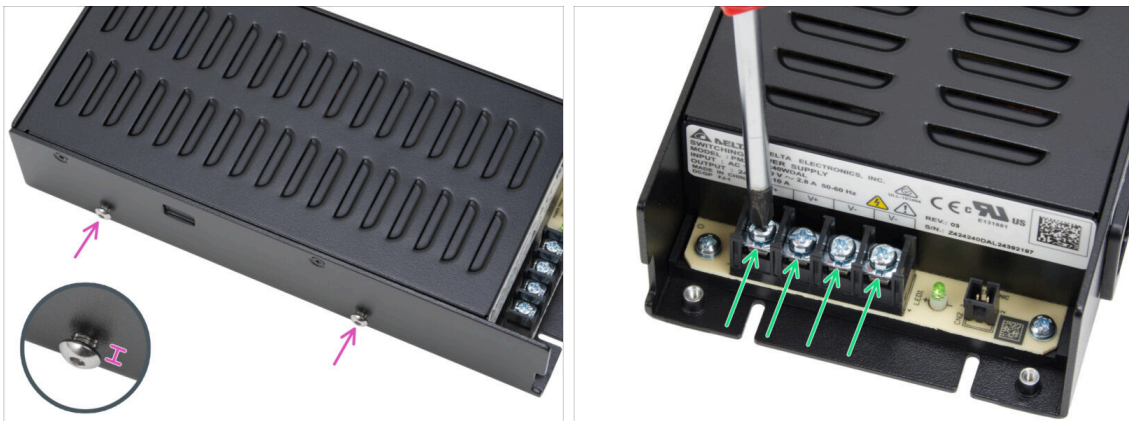

● Insert two M4x6r screws into the left side of the PSU. **Do not tighten them completely.** Leave at least a 4 mm (0.16 in) gap between the screw head and the PSU.

● Slightly loosen all four power terminal screws on the PSU. **Do not remove them.** 3-4 turns are enough.

## STEP 15 Power cables info

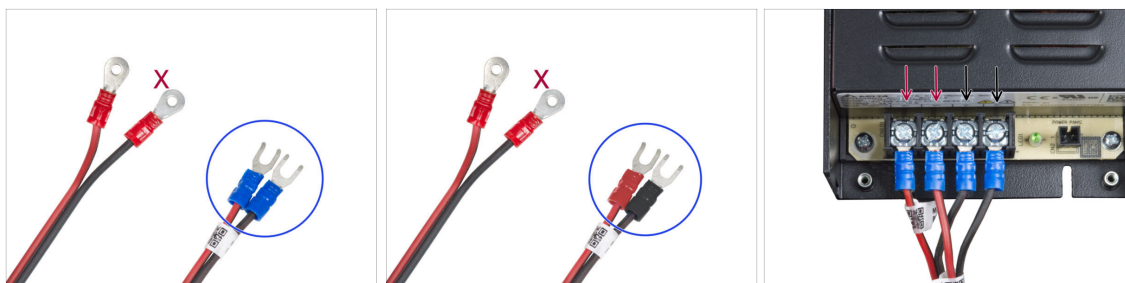

- i** In the following steps, we will be connecting the power cables one by one. The terminal screws are installed on the PSU already. Loosen them but **don't remove them completely** so they don't get mixed up with the other type of screws used on the xBuddy board side of the cable. Each of the two power cables has two leads. One has a prevailing **red color = positive / +**  
 One has a prevailing **black color = negative / -**
- Note that the power cables have different connectors on each end. For now, prepare the U-shaped connectors (crimping tube color may vary).
- **Note that the polarity of the terminals on the PSU is:**

  - Positive (V+)
  - Positive (V+)
  - Negative (V-)
  - Negative (V-)
- i** The red cable (positive) may have a black stripe on it. Similarly, the black cable (negative) can have a red stripe on it.
- ⚠** **Do not connect any cables yet, wait until you have been prompted.**

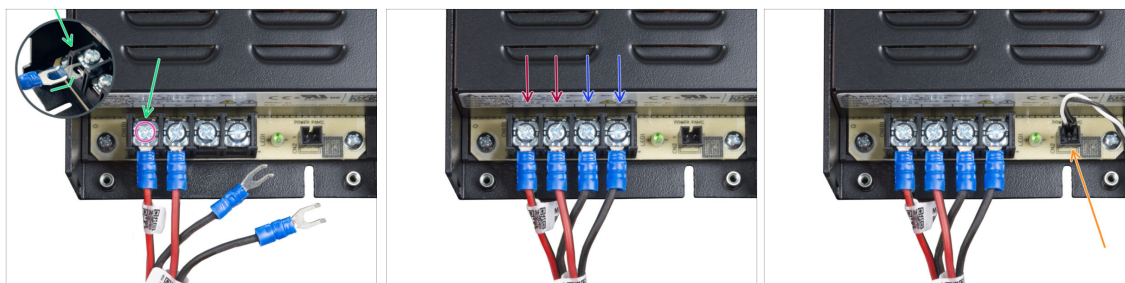
**STEP 16** Connecting the PSU

- Take the RED wire and slide the fork connector all the way into the first (positive) terminal from the left on the bottom of the PSU. Make sure the steel washer is above the "fork" connector.
- Tighten the terminal screw firmly.
- Use the same procedure to connect the second red wire to the second terminal slot from the left.
- Connect two black wires to the third and fourth terminal slots using the same procedure.
- Plug the black connector of the power panic cable to the right most connector.
- Put the assembly aside for a while.

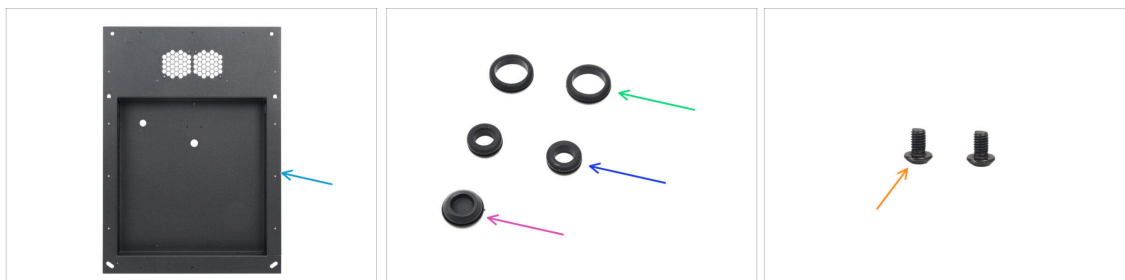
**STEP 17** Back panel: parts preparation

- **For the following steps, please prepare:**
- Back panel (1x) found in the Metal parts 1/3 package
- Grommet 19/16 mm (2x) large one - found in the Electronics & Fasteners package
- Grommet 13.5/10 mm (2x) small one - found in the Electronics & Fasteners package
- Sealing plug 15.5 mm (1x) found in the Electronics & Fasteners package
- M3x4rT screw (2x)

## STEP 18 Installing grommets: back panel top



- Position the back panel as shown in the first image. Use the two oval holes as a reference.
- Insert the sealing plug into the center hole.
  - **The sealing plug is not symmetrical.** Insert the side with the smaller diameter facing downward.
- Insert one small grommet to the left circle hole.
- Insert one small grommet into the oval hole.

## STEP 19 Installing grommets: sides

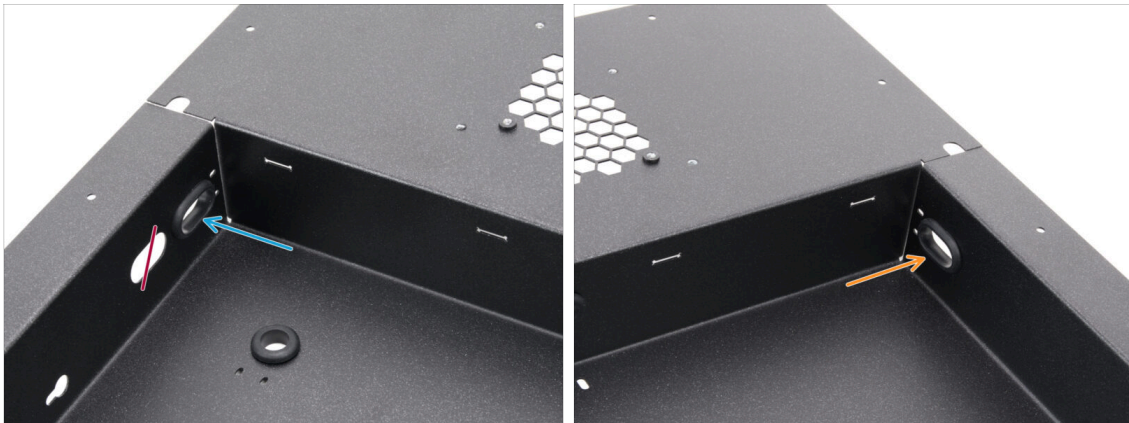

- Focus on the left top side of the back panel and locate two oval holes.
- Insert one large grommet into the oval hole closest to the corner.
- Move to the right top side of the back panel and insert one large grommet to the oval hole.

## STEP 20 Aligning the PSU

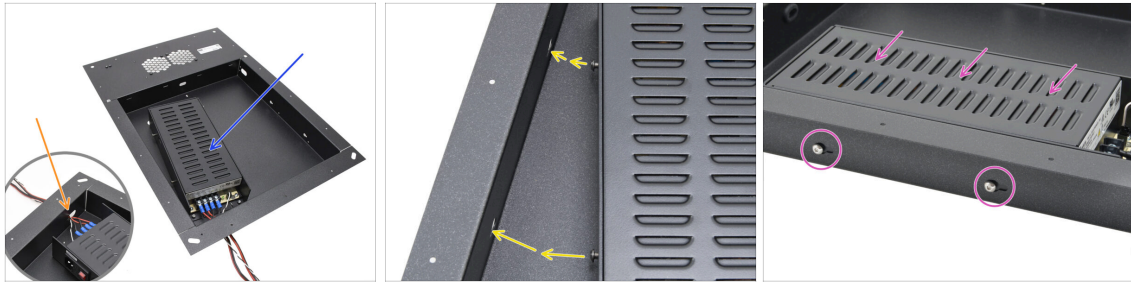

- ◆ Carefully insert the PSU into the rear panel pocket.
- ◆ Push the cable bundle through the opening on the bottom of the panel.
- ◆ Align the screws on the PSU to the holes on the left side of the back panel.
- ◆ Slide the PSU so that the screws go through the holes.

## STEP 21 Mounting the PSU

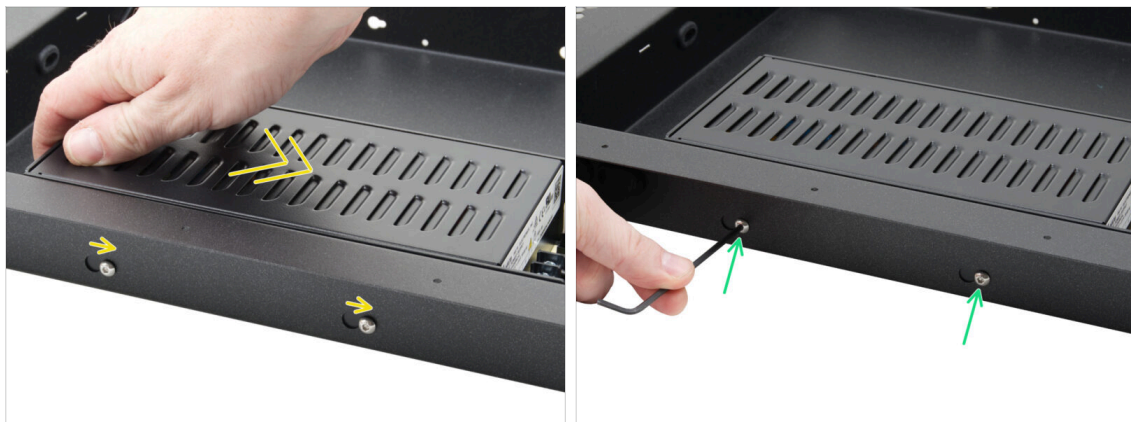

- ◆ Gently slide the PSU so that the position of the screws moves to the end position of the keyhole-shaped holes.
- ◆ Maintain the PSU position and fully tighten both screws.

## STEP 22 Aligning the xBuddy box assembly

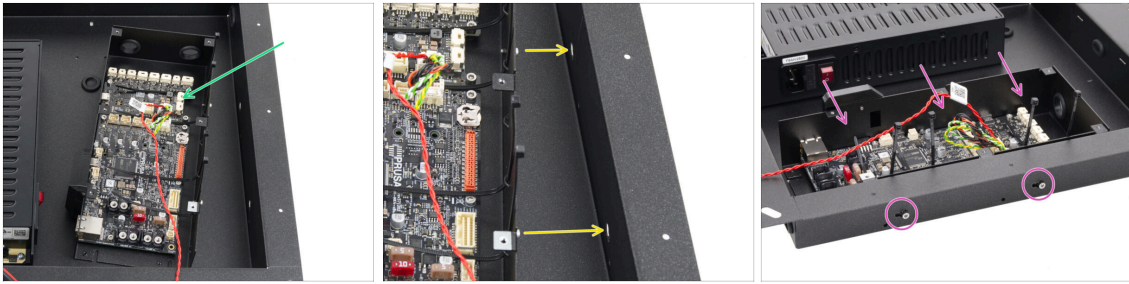

- ◆ Carefully insert the xBuddy box assembly into the rear panel pocket.
- ◆ Align the screws on the xBuddy box to the holes on the right side of the back panel.
- ◆ Slide the xBuddy box so that the screws go through the holes.

## STEP 23 Mounting the xBuddy box

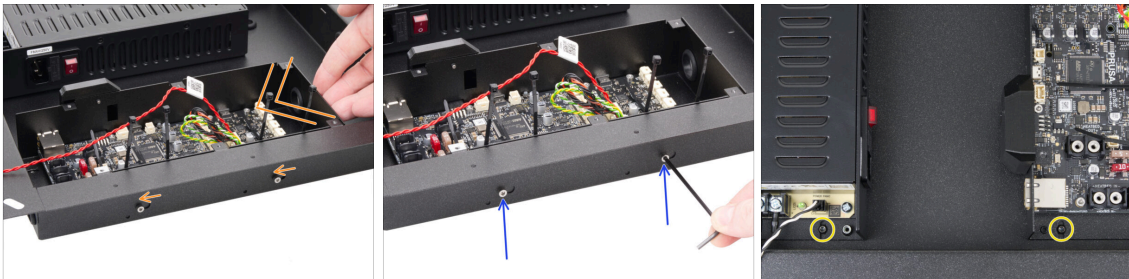

- ◆ Gently slide the xBuddy box assembly so that the position of the screws moves to the end position of the keyhole-shaped holes.
- ◆ Maintain the xBuddy box position and fully tighten both screws.
- ◆ Fix the PSU and xBuddy box assembly to the back panel by tightening the two M3x4rT screws.

## STEP 24 PSU-cable-cover: parts preparation

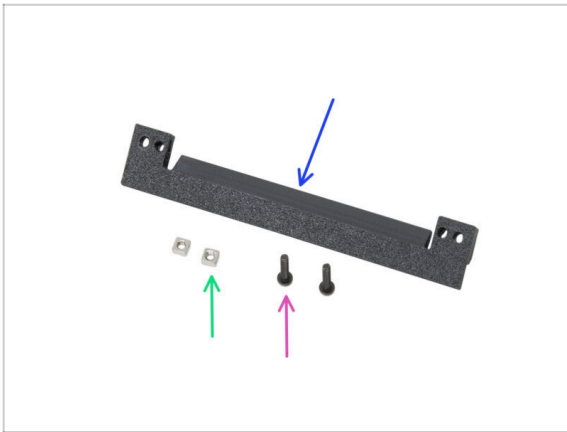

- For the following steps, please prepare:
- PSU-cable-cover (1x) found in the Printed parts package
- M3nS nut (2x)
- M3x10rT screw (2x)

## STEP 25 Preparing the PSU-cable-cover

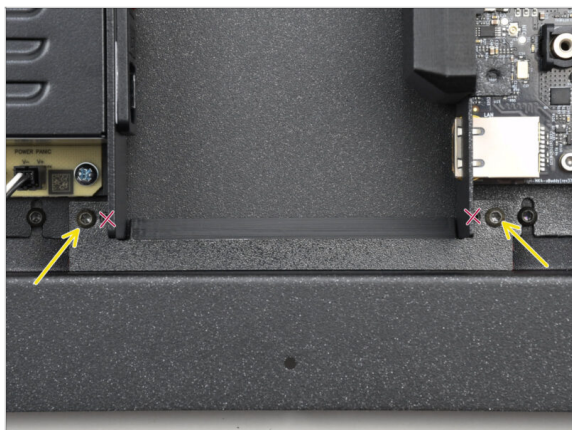

- Insert one M3nS nut into the hole on each end of the PSU-cable-cover.
- Ensure the holes are aligned.

**STEP 26** PSU-cable-cover installation

- ◆ Attach the PSU-cable-cover inbetween the PSU and the xBuddy box.
- ◆ Secure the cover with two M3x10rT screws in the outermost holes of the part.

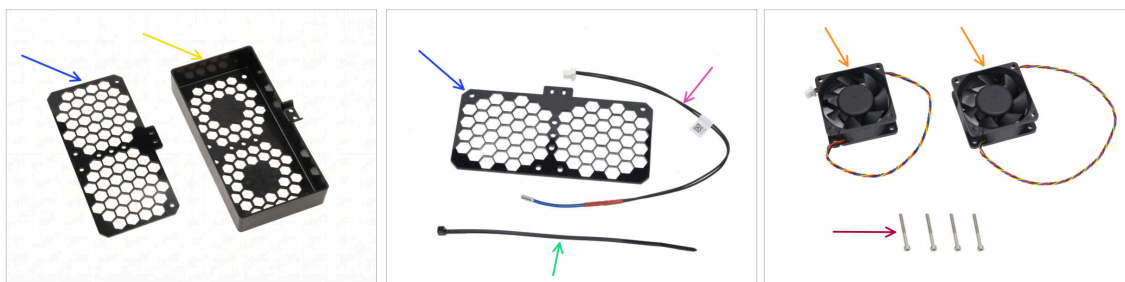
**STEP 27** Chamber fans: parts preparation

◆ **For the following steps, please prepare:**

- ◆ Fan grid (1x) *found in the Electronics & Chamber parts package*
- ◆ **Part update:** We have replaced the older flat fan grid with a new enclosing fan grid.
- 📌 **The assembly process remains exactly the same for both versions.** Please refer to the pictures in the next step to see how the new version looks and how to properly route the cables.
- ◆ Chamber thermistor 260 mm (1x) *found in the Electronics & Chamber parts package*
- ◆ Zip tie (1x)
- ◆ Cooling fan (2x) *found in the Electronics & Chamber parts package*
- ◆ M3x30 screw (4x)

## STEP 28 New fan cover - visual reference

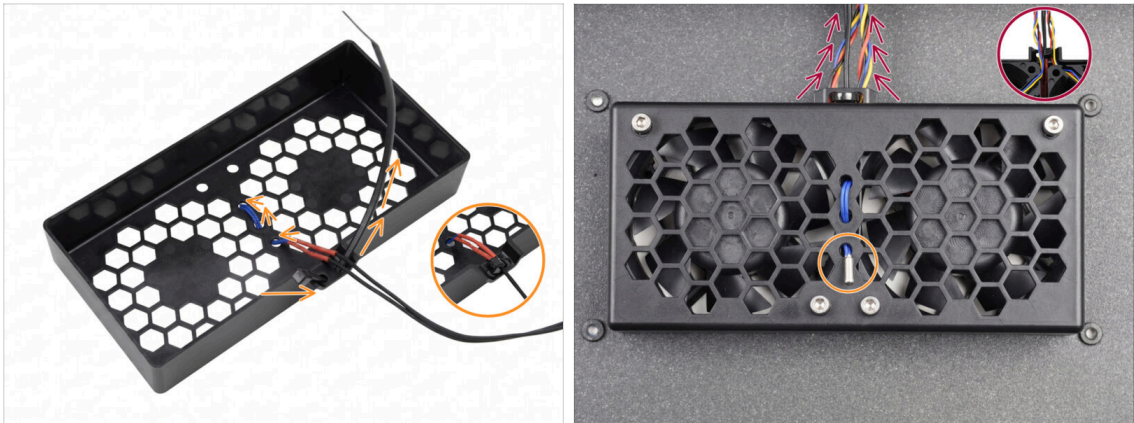

- i** The images in this step are for visual reference only. The assembly procedure for the new enclosing fan cover is exactly the same as the older version.
- 🟡** When assembling, pay close attention to the orientation. Unlike the older version where both sides were the same, the new fan cover has a specific inside and outside.
- 🟠** The second image shows the fans and proper cable routing fully installed under the new cover. It is intended for visual reference only and does not change the assembly procedure.
- ⚠️** This step is for visual reference only. Do not assemble any parts until instructed in the following steps.

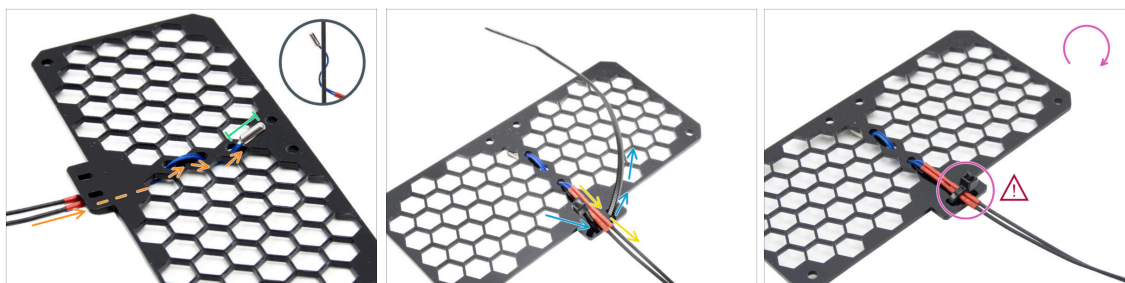
**STEP 29** Assembling the fan grid

- Guide the thermistor cable under the grid. Thread it in the direction shown in the picture.
- ⓘ The **older (flat) fan grid has identical sides**. If you have the **new fan cover**, use the inside of the cover as **shown in the previous visual reference step**.
- Leave the whole thermistor part sticking out.
- Turn the grid over and push the zip tie through the pair of holes on the grid's protrusion.
- Route the thermistor cable in between the zip tie parts.
- Carefully secure the thermistor cable by tightening the zip tie. **Do not overtighten it, it may damage the cable.**
- ⚠ **Make sure that the pawl of the zip tie is located on the opposite side of the thermistor.**

**STEP 30** Attaching the fans

- Place and orient the back panel according to the picture. The grid cutouts must be facing you.
- Attach both fans to the grid in the back panel.
- ⚠ **The side of the fan without the sticker must be facing up.**
- Orient the fans so that the cables run from the corners in the centre.
- Let the cables hang freely for now, ensuring they are not pinched during handling.

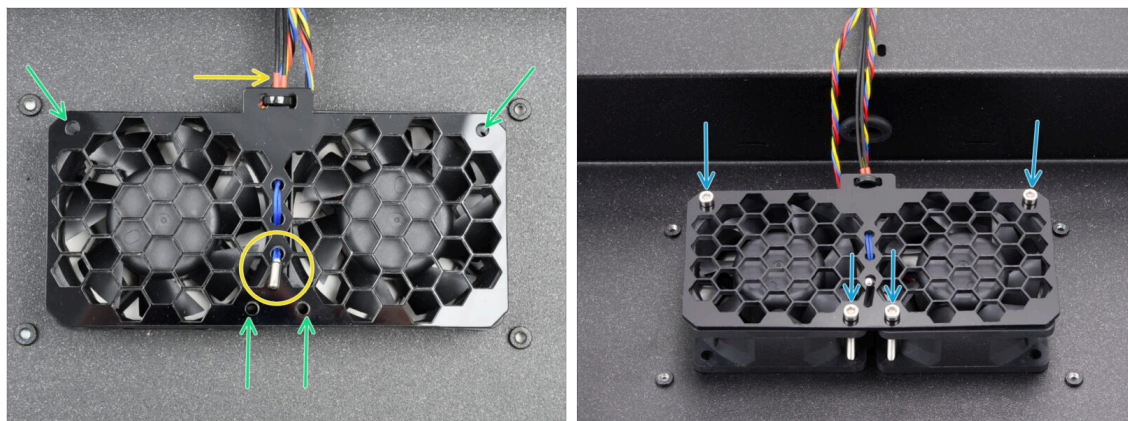
**STEP 31** Covering the cooling fans

- Place the fan grid assembly on the cooling fans.
  - ⚠ **Make sure that the thermistor is pointing up and its cable runs under the grid.**
- Align holes in the fans, fan grid and the back panel.
- Secure the fan assembly to the back panel with four M3x30 screws.
  - ⚠ **Do not overtighten the screws to avoid damaging the grid.**

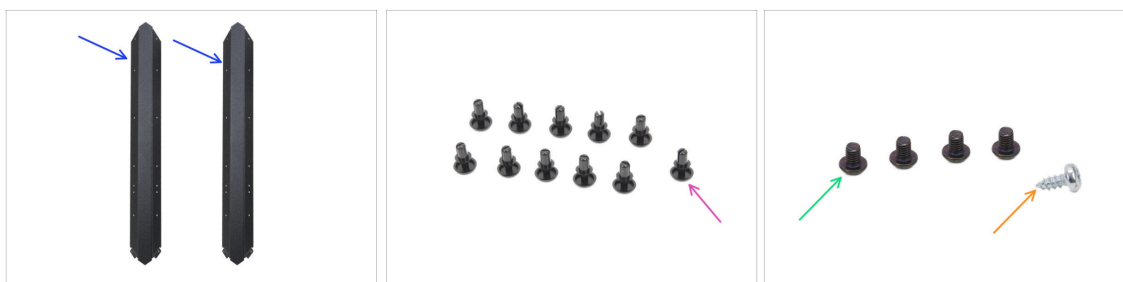
**STEP 32** Rear profiles: parts preparation

- **For the following steps, please prepare:**
- Rear profile (2x) found in the Metal parts 1/3 package
  - ⓘ Take two of the longer ones.  
Note that the other two longer ones differ by having cutouts.
- Nylon rivet (11x)
- M3x4rT screw (4x)
- 2.9x6.5sT self-tapping screw (1x)

## STEP 33 Installing the rear profiles



- ◆ Take the bottom assembly and turn it so the rear side (with one motor in the center) faces you.
- 📌 Focus on the right rear corner—the side with the longest oval opening in the bottom panel.
- ◆ Attach the rear profile to the right corner, using the **end without flanges**.
- ◆ Align the hole on the rear side and secure it with the M3x4rT screw.
- ◆ Secure the corner on the other side with a second M3x4rT screw - each corner will be secured with two M3x4rT screws.
- ◆ Proceed the same with the second rear profile on the rear left corner.

## STEP 34 Mounting the back panel

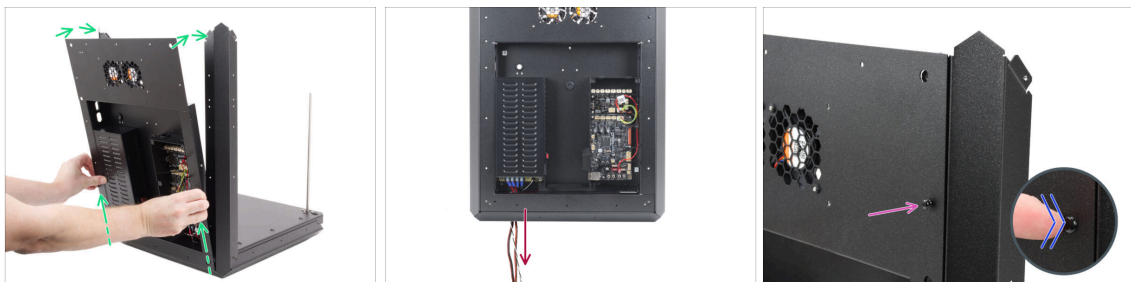

- ◆ Slightly lift the back assembly and gently place it on the base assembly and rear profiles.
- ◆ Pull the power cables through the opening in the bottom assembly.
- ◆ Insert one nylon rivet through the rear panel and rear profile on the top right side.
- ◆ Push the rivet head with your finger until it is fully seated.

## STEP 35 Securing the Back panel



- Install all eleven nylon rivets around the back panel assembly to secure it.
  - Install the 2.9x6.5 self-tapping screw into the bottom left opening on the back panel.
-  Don't overtighten to avoid stripping the self-tapping thread.

## STEP 36 Power Terminal Screws Preparation



- **For the following steps, prepare:**
- 6-32 Power Terminal Screw (4x)

## STEP 37 Connecting the power cables

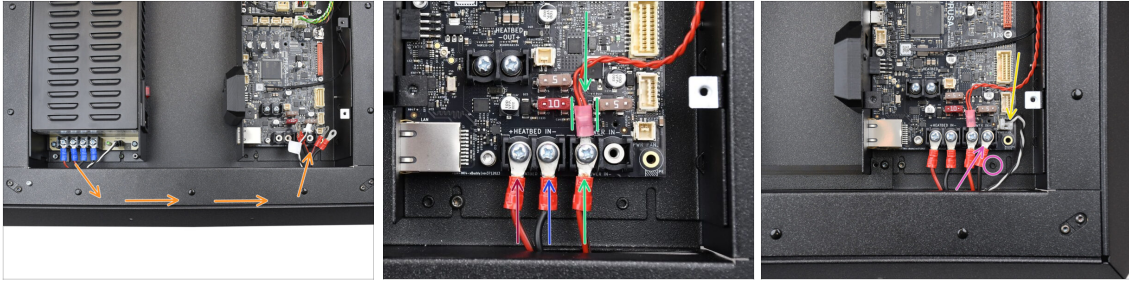

- 🟠 Guide the power cable bundle through the rear panel, towards the xBuddy board.
- 🔴 Take one red cable from the PSU and connect it to the leftmost terminal on the xBuddy board using the 6-32 terminal screw. Tighten it firmly but do not overtighten.
- 🟠 Attach the black PSU cable to the second terminal. Tighten it firmly, but avoid overtightening.
- 🟢 Take the second red cable from the PSU and stack it with the red cable from the extension board. Secure **both cables together** in the third terminal using the terminal screw.
- 🔗 Carefully guide the xBuddy extension cable between the fuses, ensuring it does not press against any of them.
- 🟡 Attach the last black PSU cable to the xBuddy, **making sure it does not obstruct the threaded hole underneath**.
- 🟡 Connect the power panic cable to the bottom right connector on the xBuddy board.

## STEP 38 Stepper splitter: parts preparation

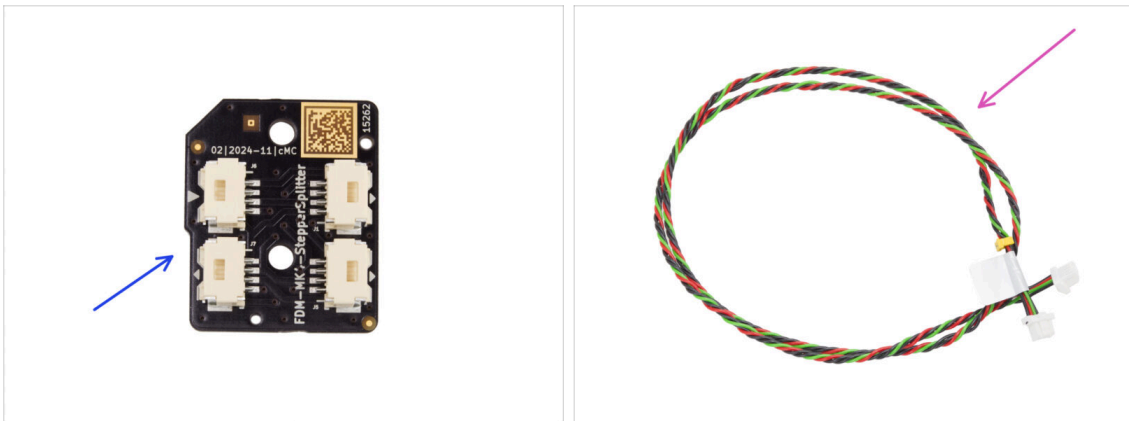

- 🟡 **For the following steps, please prepare:**
- 🟠 Stepper splitter (1x) *found in the Electronics & Chamber parts package*
- 🟡 Stepper splitter cable (1x) *found in the Electronics & Fasteners package*

## STEP 39 Guiding the Stepper splitter cable



- Very carefully turn the assembly on its back (back panel).
  - **It is recommended to support the rear of the assembly** with a soft, raised pad to prevent it from resting on the protruding Wi-Fi module.
  - ⓘ Tip: Use the foam padding from the sheet metal parts package or an empty cardboard box.
- Guide the Stepper splitter cable through the three zip ties on the left side.
  - For now, leave the side with the label hanging freely outside.
- Guide the Z-axis motor R cable through the three zip ties on the left side.
  - ⚠ **Do not tighten the zip ties at this moment.**

## STEP 40 Connecting the Stepper splitter

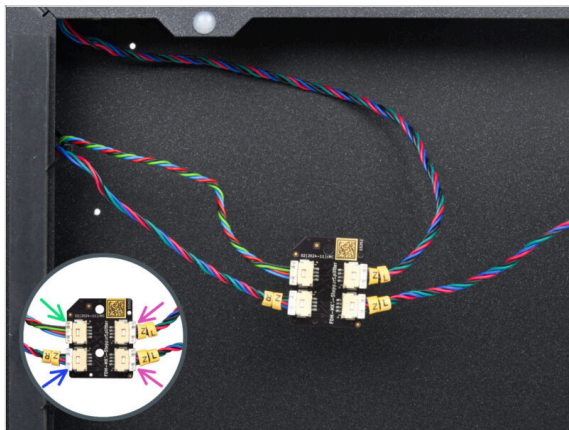

- **Connect the Z motor cables to the stepper splitter:**
  - Stepper splitter cable
  - Z-axis motor R
  - Z-axis motor L
  - Z-axis motor L

## STEP 41 Mounting the Stepper Splitter

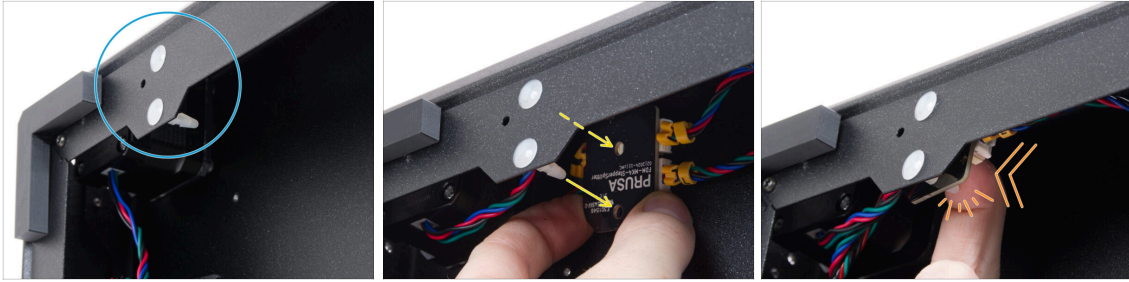

- ◆ Locate two spacer pins in the bottom frame.
- ◆ From the inside of the frame, prepare the Stepper splitter and attach its holes opposite the pins.
  - ◆ Check the correct orientation of the part by the logo on the board. **The logo is upside down.**
- ◆ Push the aligned Stepper Splitter onto the pins until you feel a click - this secures the Stepper Splitter. Push in the center of the board.
- ⓘ It is necessary to apply a significant pressure to seat the part in. Yet, be very careful not to damage the components.

## STEP 42 LCD cable: parts preparation

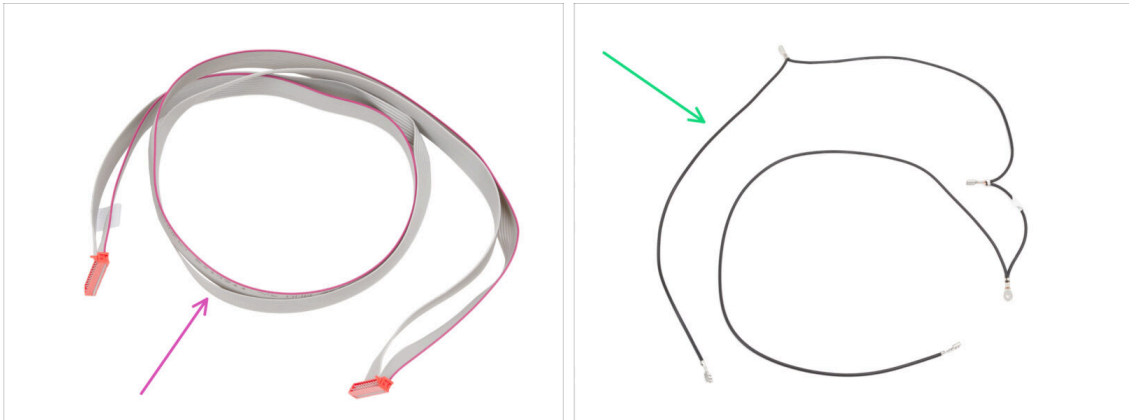

- ◆ **For the following steps, please prepare:**
- ◆ xLCD cable (1x) found in the *Electronics & Fasteners* package
- ◆ Main FE cable (1x) found in the *Electronics & Fasteners* package

**STEP 43** Guiding the LCD cable

- ◆ Guide the Stepper splitter cable through the oval hole to the electronics.
- ◆ Take the end of the xLCD cable with the QR code label.
- ◆ Push a few centimeters of the xLCD cable (the end with the QR code label) through the oval hole in the bottom panel.
  - ⓘ The cable must be slightly folded to pass through the hole.
- ◆ Guide the xLCD cable through the zip ties on the left side of the frame.
- ◆ Guide the xLCD cable through the rectangular opening in the front profile. Keep protruding approximately 6 cm (2.36 in).
  - ◆ Leave the cable hang freely for now.

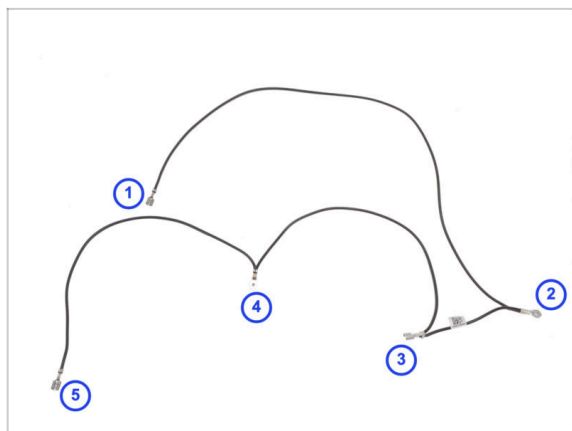
**STEP 44** Main FE cable INFO

- ◆ Lay out the Main FE cable as shown in the picture, ensuring each connector is positioned accordingly.
- ◆ The connectors are numbered in the picture for reference only. This numbering will be used in the following steps to help with proper connections.
  - ⓘ Note: We will always indicate which connector to use in the following steps. However, it's a good idea to remember this overview for easier assembly.

### STEP 45 Connecting the FE cable (no 3.)

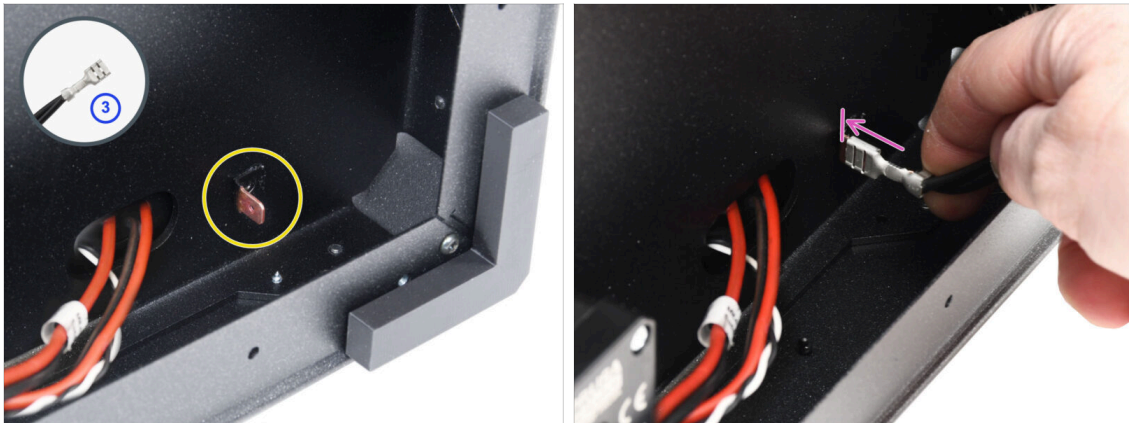

- ◆ Prepare the connector number 3.
  - ⓘ That's the female faston connector in the middle of the cable.
- ◆ Locate the male Faston connector in the bottom right corner.
- ◆ Slide the FE cable connector completely onto the Faston connector.

### STEP 46 Guiding the FE cable (no. 2)

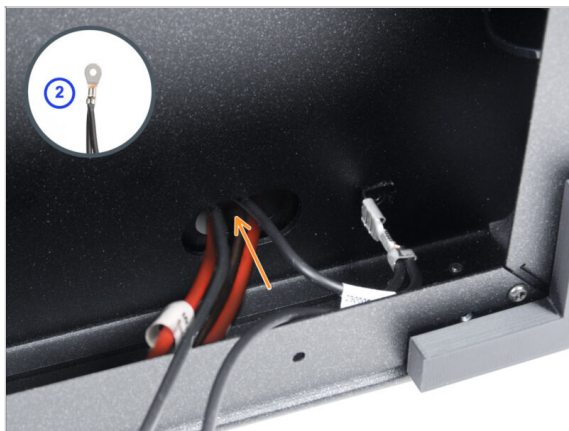

- ◆ Take the FE cable connector number 2.
  - ⓘ The round connector nearby.
- ◆ Insert the connector loosely into the hole in the bottom panel.

### STEP 47 Guiding the FE cable (no. 1)



- ◆ Take the connector number 1 and guide it through the zip ties on the right side of the frame.
- ⓘ That is the long part with just one faston connector at the end.
- ◆ Push the connector through the rectangular opening in the front profile. Keep protruding approximately 6 cm (2.36 in).
- ◆ Leave the cable hang freely for now.
- ◆ Tighten all three zip ties. Cut off the excess.

### STEP 48 Guiding the FE cable (no. 4 and 5)

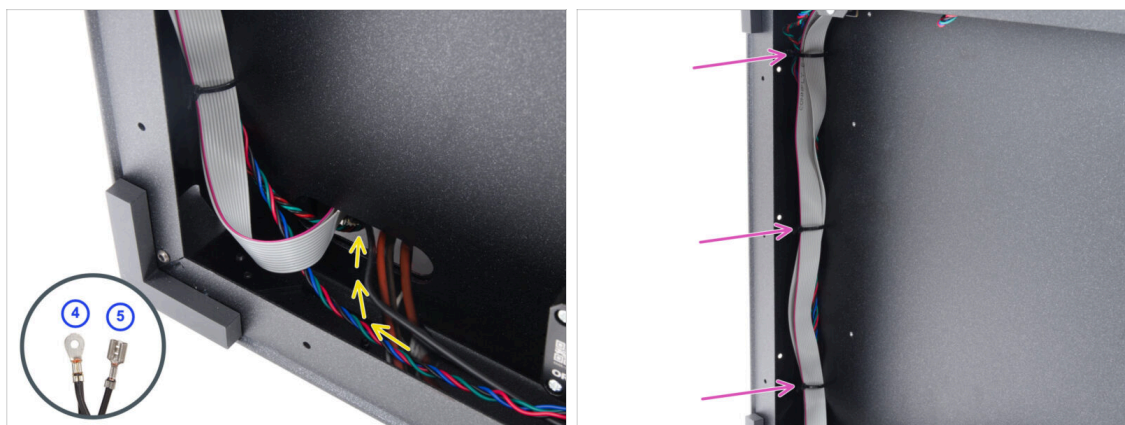

- ◆ Take the FE cable connectors number 4 and 5.
- ◆ Push both connectors through the leftmost hole in the bottom. Leave them free for now.
- ◆ Tighten all three zip ties on the left side of the frame. Cut off the excess.
- ◆ There's no need to fully tighten the zip ties. However, the cables must still be easy to move for any necessary length adjustment during connection.

## STEP 49 Cable Bundle Cleanup

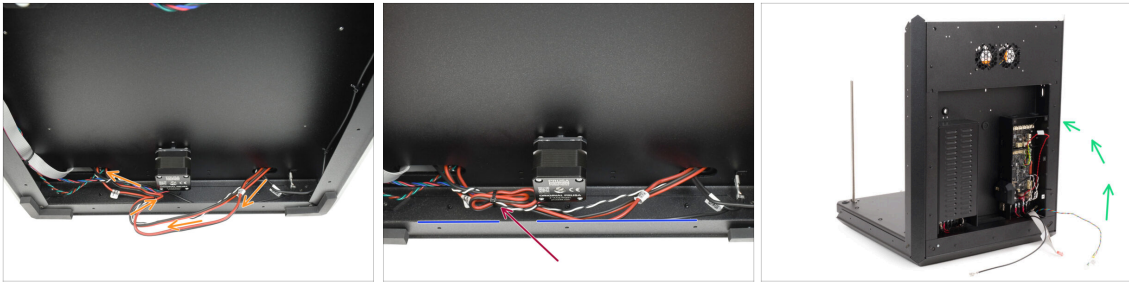

- 🟠 On the bottom, loop the power cable bundle around the Z-motor cable to shorten it.
- 🔴 Secure the loop to the Z-motor cable with a zip-tie.
  - 🟠 Make sure the cables are kept at a reasonable distance from the metal profile, while also preventing them from being overly tight.
  - ⚠️ This prevents cables from hanging below the metal profiles, where they could get caught and damaged. High current flows through these cables, so damaging them might cause a serious harm to the printer and its surroundings!
- 🟢 Carefully lift the printer upright.

## STEP 50 FE cable - xBuddy: parts preparation

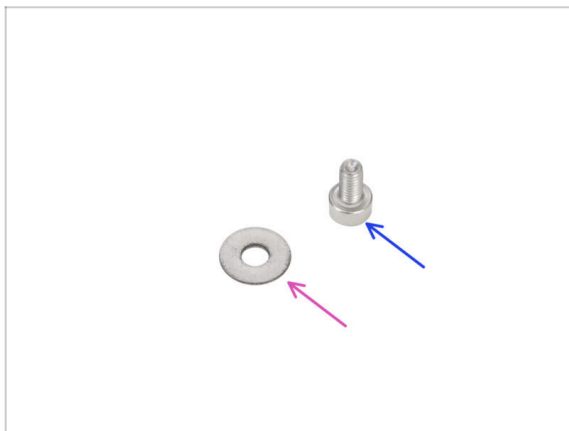

- 🔴 For the following steps, please prepare:
  - 🟠 M3w washer (1x)
  - 🟠 M3x6 screw (1x)

## STEP 51 Connecting the FE cable: xBuddy



- ◆ Put the printer back on its feet. And focus on the rear side.
- ◆ Take the connector number 4 and connect it to the xBuddy using the M3x6 screw and M3w washer.
- ⚠ **The M3 washer must be between the screw head and the connector.**
- ◆ Guide the FE cable (number 5) alongside the xBuddy box and pass it through the right-side holes out of the box.
- ◆ Guide the Stepper splitter cable alongside the xBuddy box and connect it to the second slot from the right in the top row on the xBuddy board (labeled ZR).

## STEP 52 Plugging the xLCD cable

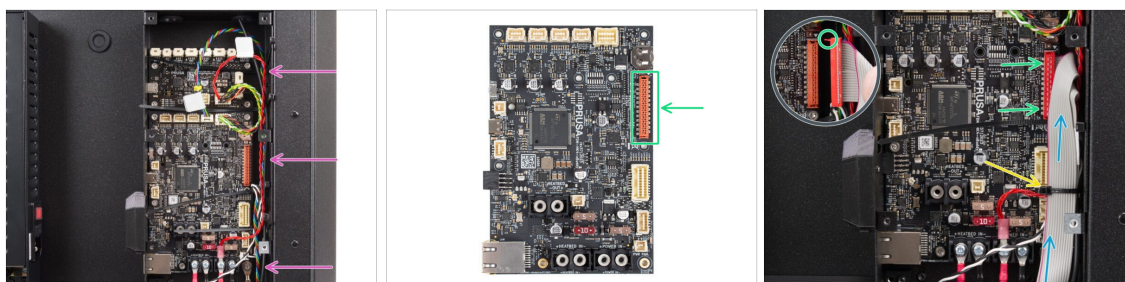

- ◆ Arrange the cables as shown - route all cables along the right side of the xBuddy box.
- ⚠ **Make sure all the cables guide through the zip ties in the xBuddy box, not under them.**
- ◆ Place the xLCD cable over the other cables and route it upwards.
- ◆ Connect the xLCD to the slot on the right side of the xBuddy. **Note the safety latch on the xLCD cable connector. The latch must fit into the upper side of the connector.**
- ◆ Secure the cable arrangement by tightening the bottom zip tie.
- ⚠ **Do not overtighten the zip tie, as it may damage the wires.**
- ◆ Carefully cut off the excess length of the zip tie. **Avoid cutting cables!**

## STEP 53 PSU-cover: parts preparation



- For the following steps, please prepare:
- CORE-One-PSU-cover (1x) found in the Printed parts package
- M3x10 screw (2x)

## STEP 54 Connecting the FE cable: PSU



- Remove the screw from the PSU board. **Do not discard it!**
- Ensure the FE connector (number 2) is routed into the PSU compartment.
- Insert the removed screw through the FE cable connector and screw it back to the PSU board.
- Note the correct orientation of the connector.
- Rotate the connector counter-clockwise, positioning it so it doesn't block the threaded hole underneath.
- Attach the PSU-cover over the PSU connectors and secure with two M3x10 screws.

## STEP 55 Haribo time



- Time to recharge for the next chapter!
- Eat the second row.
- ⚠ **No cheating**—eat only the number shown!

## STEP 56 Done



- Congratulations! The back assembly is installed.
- Now continue to the next chapter.

## 4. Heatbed assembly

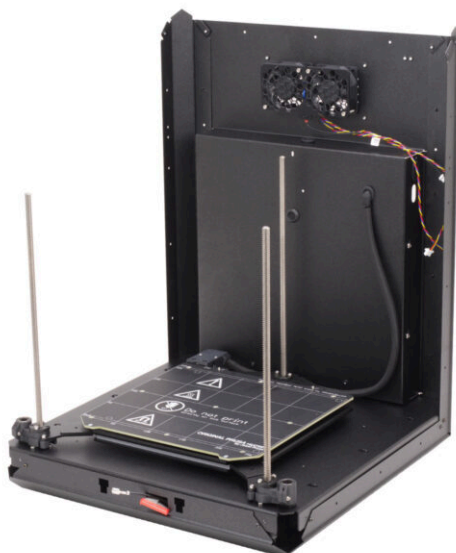

## STEP 1 Tools necessary for this chapter

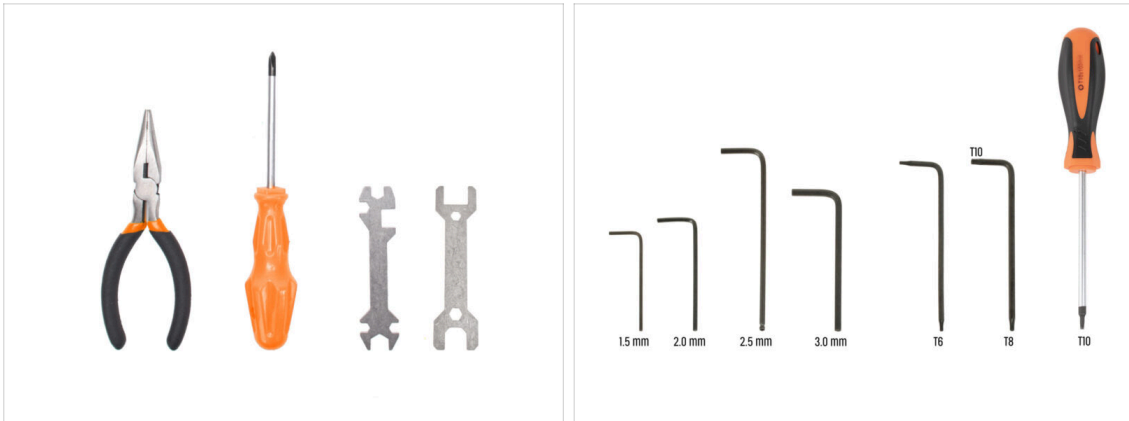

● **For this chapter, please prepare:**

- Needle-nose pliers
- Universal wrench
- Wrench 13-16
- Philips (PH2) screwdriver
- 2.5mm Allen key
- 2.0mm Allen key
- T10 torx key / T10 torx screwdriver

## STEP 2 Heatbed: parts preparation

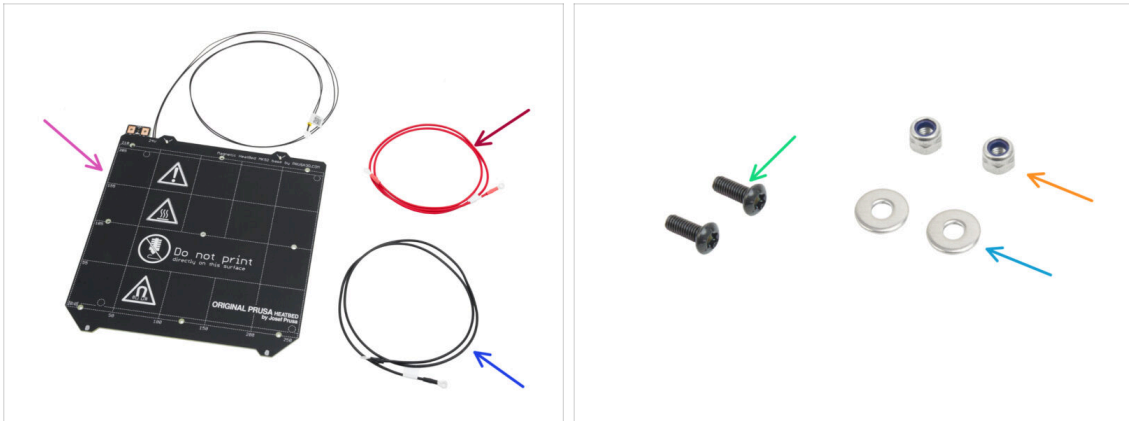

### For the following step please prepare:

- Heatbed MK52 24V (1x)
- Heatbed cable red (1x) *found in the Electronics & Fasteners package*
- Heatbed cable black (1x) *found in the Electronics & Fasteners package*
- M3x10rT screw (2x)
- M3nN nut (2x)
- M3w washer (2x)

## STEP 3 Heatbed Cable Assembly 1

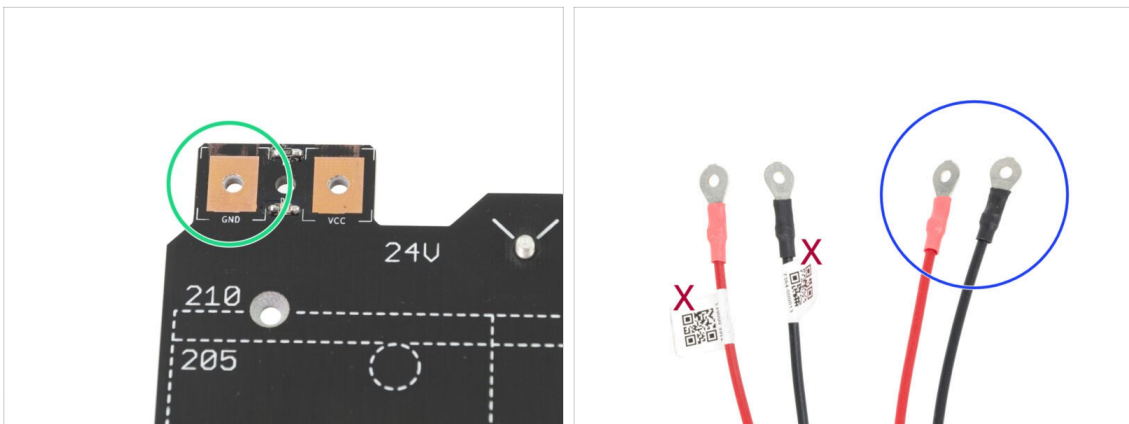

- Follow the polarity markings on the heatbed:

The pad labeled **GND** should be coupled with the **BLACK WIRE**.

- Take both power cables. Note the labels on each. Use the unlabeled ends for the heatbed connection.

## STEP 4 Heatbed Cable Assembly 2

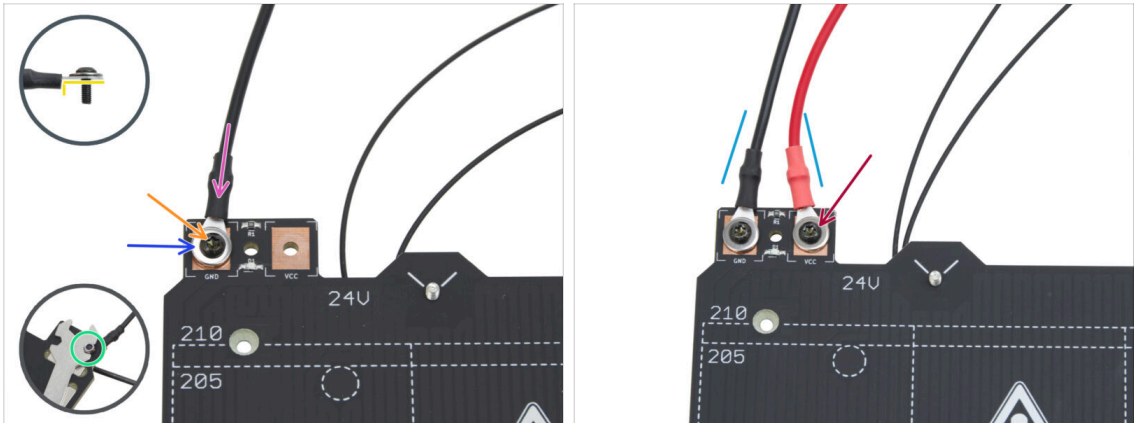

- Place the black cable onto the "GND" pad.
- Orient the lug connector with the thicker part facing downward.
- Place the M3w washer on top of the connector.
- Insert the M3x10rT screw through all the components.
- Attach the M3nN nut onto the M3x10rT screw from below and tighten it slightly.
- Using the same technique, attach the red cable to the "VCC" pad.
- Guide the heatbed cables slightly inward in a "V" shape, **then fully tighten the nuts from below.**

## STEP 5 Bed-cable-cover-bottom: parts preparation

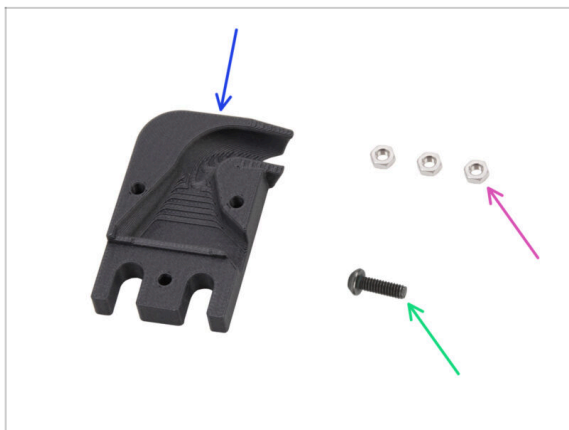

- **For the following steps, please prepare:**
- Bed-cable-cover-bottom (1x)
- M3n nut (3x)
- M3x10rT screw (1x)

## STEP 6 Attaching the cable cover

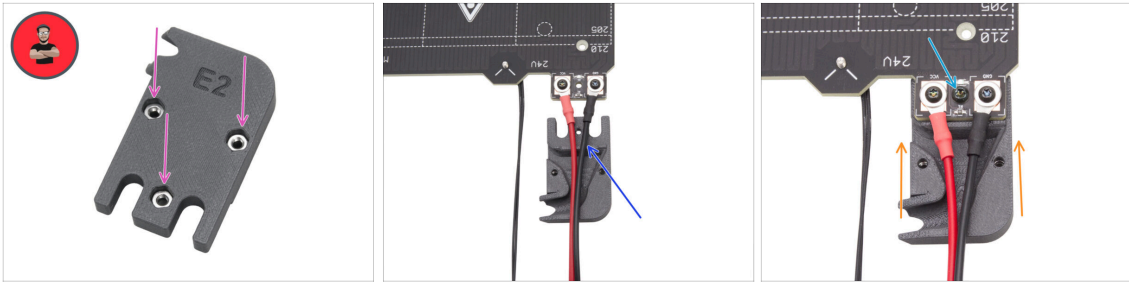

- ◆ Insert three M3n nuts into the Bed-cable-cover-bottom part.
- ⓘ Pro tip: Use the screw-pulling technique.
- ◆ Make sure the nuts are fully inserted and held in place.
- ◆ Insert the Bed-cable-cover-bottom under the heatbed cables. Note the orientation of the part.
- ◆ Slide the Bed-cable-cover-bottom under the cable joint of the heatbed.
- ◆ Line up the hole in the heatbed with the cable cover and secure it with the M3x10rT screw.

## STEP 7 Heatbed carriage: parts preparation



- ◆ **For the following steps, please prepare:**
- ◆ Heatbed carriage (1x) *found in the Metal parts 1/3 package*
- ◆ Expansion joint (8x)
- ◆ M3x4r screw (8x)
- 🔩 The Fasteners package includes both M3x4r and M3x4rT screws. Make sure you have the correct type prepared.

## STEP 8 Preparing the heatbed carriage

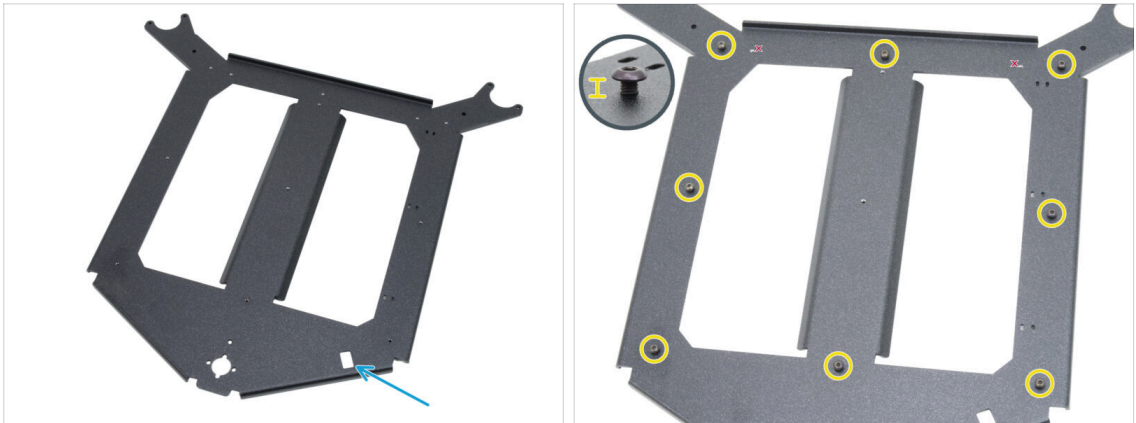

- Place the heatbed carriage in front of you in the same orientation as in the picture.
- Make sure the **rectangular cutout is facing you on the right side**.
- Insert eight M3x4r screws around the heatbed carriage.
- ⚠ **Do not tighten completely, leave a gap of approximately 3 mm (0.12 in).**

## STEP 9 Installing the expansion joints



- Attach one expansion joint to any M3x4 screw in the same orientation as shown.
- Note the U-shaped "groove" for the screw inside the expansion joint - point it towards the screw.
- Slide the expansion joint onto the screw.
- Grasp the expansion joint in the rectangular cutout of the universal wrench.
- Position the key with the expansion joint in its correct orientation as shown in the illustration.
- **Maintain the expansion joint in the correct position** and firmly tighten the M3x4r screw through the expansion joint with a 2.0 mm Allen key.
- ⚠ **Repeat this procedure for all other expansion joints. Follow their correct position!**

## STEP 10 RGB LED strip: parts preparation

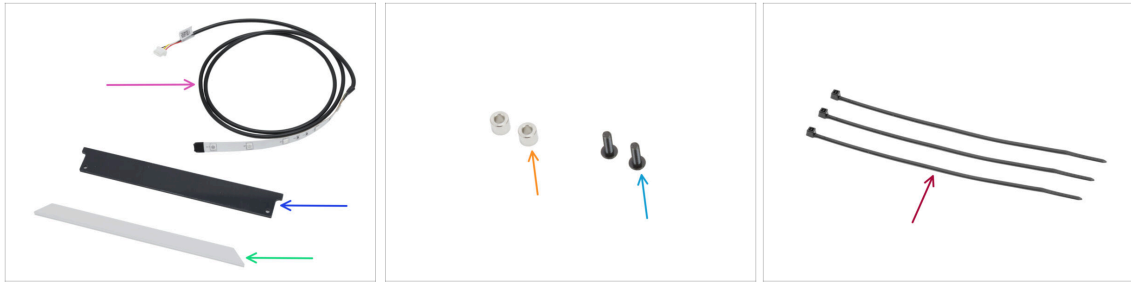

### For the following steps, please prepare:

- RGB LED strip 166 mm (1x) *found in the Electronics & Fasteners package*
  - ⚠ **Avoid direct contact with the LED and resistors on the LED strip.**
- LED status cover (1x) *found in the Electronics & Chamber parts package*
- LED strip diffuser (1x) *found in the CoreXY parts + Hinges set package*
- Spacer 3.2/6x5 mm (2x) *found in the Electronics & Fasteners package*
- M3x10rT screw (2x)
- Zip tie (3x)

## STEP 11 Installing the LED strip

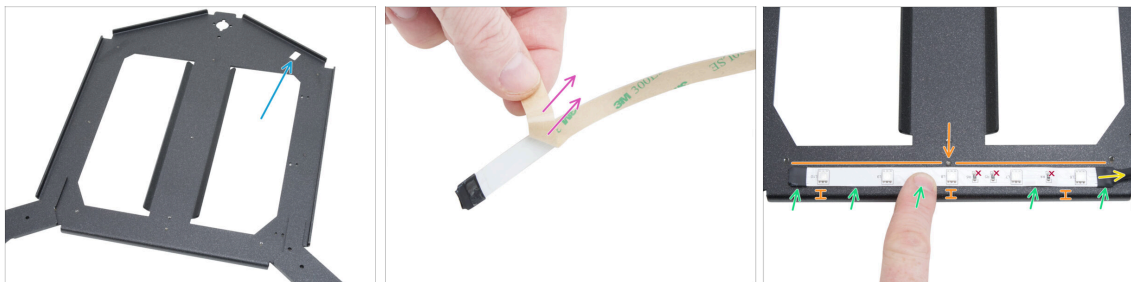

- Place the heatbed carriage in front of you in the same orientation as in the picture.
  - Make sure the **rectangular cutout is far from you and on the right side**.
- Carefully peel off the protective (paper) layer from the RGB LED strip.
  - ⚠ **After removing the protective layer, the RGB LED strip is adhesive.**
- Stick the RGB LED strip evenly to the front of the heatbed carriage, approximately 3 mm (0.12 in) from the folded edge. Align the middle LED with the screw on the carriage.
  - The RGB LED strip **cable must point to the right**.
- After sticking, press lightly on the blank areas of the strip to ensure adhesion. **Do not touch LEDs and resistors!**

## STEP 12 Attaching the LED strip diffuser

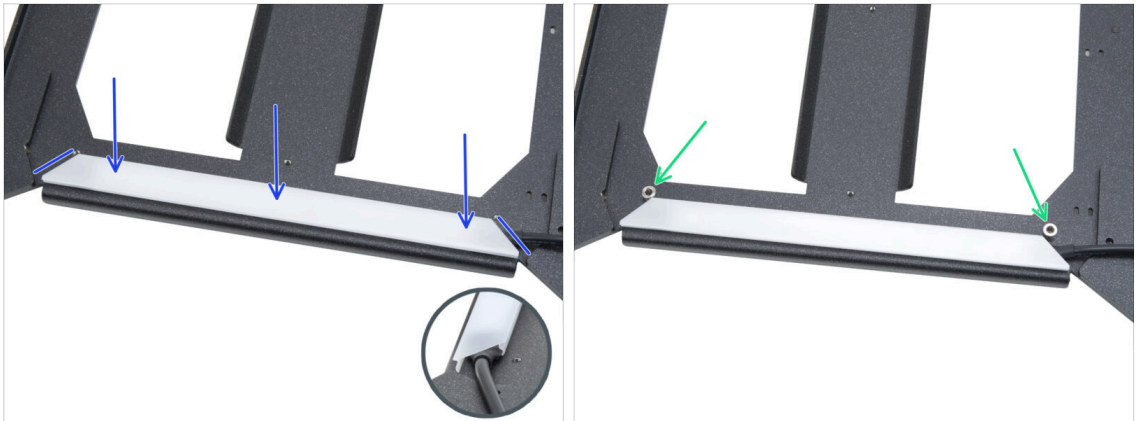

- ◆ Place the LED strip diffuser over the RGB LED strip. Note the orientation of the part - according to the beveled edges.
- ◆ Place two spacers 3.2/6x5 mm on the holes in the edges of the LED assembly.

## STEP 13 Covering the RGB LED strip

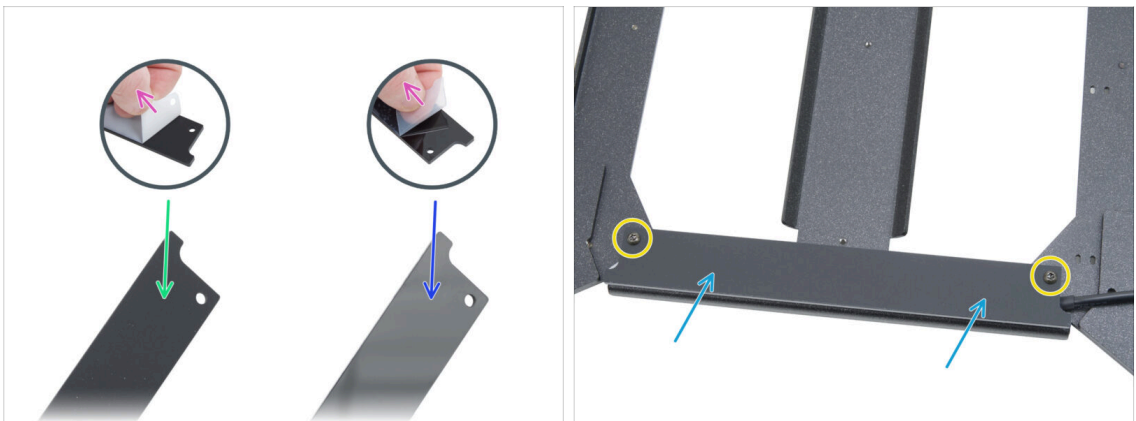

- ◆ From both sides of the LED status cover, peel off the protective layers.
- ◆ Note that one side of the cover is matte.
- ◆ The other side of the cover is glossy.
- ◆ Attach the LED strip cover to the assembly, **matte side up**.
- ◆ Secure all parts together by inserting and tightening two M3x10rT screws. **Do not overtighten the screws**, as it may crack the cover.

## STEP 14 Guiding the RGB LED strip cable

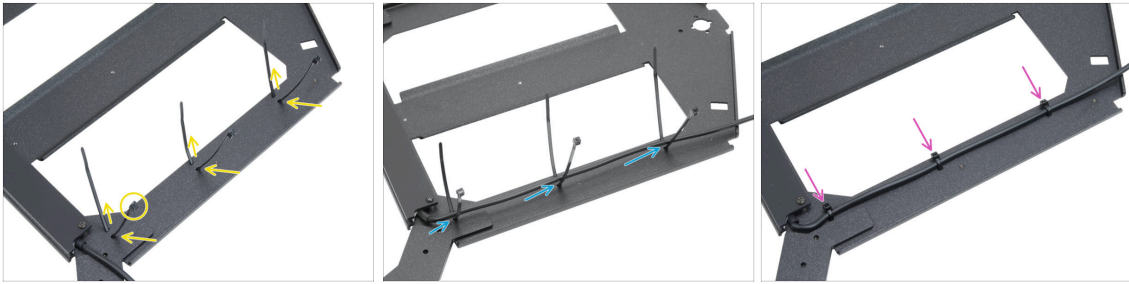

- ✦ Thread the three zip ties along the **RIGHT SIDE** of the heatbed carriage. Make sure the zip tie heads are facing outward.
- ✦ Guide the RGB LED strip cable through all zip ties.
- ✦ Then tighten all three zip ties. Cut off excess zip ties.

## STEP 15 Bearing Lubrication Preparation



- ✦ **For the following steps, prepare:**
  - ✦ LM8UU Bearing (2x) *removed from the MK4S printer*
  - ✦ Prusa lubricant applicator 8mm (1x)
  - ✦ Prusa lubricant (1x)
  - ✦ Several paper towels to wipe oil and grease from the bearing surface.
- ⚠ **Use the lubricant wisely, less is better! Using too much of the lubricant may cause issues.**

## STEP 16 Bearing Lubrication



**i** Use any piece of fabric as a pad to protect your working surface from grease.

**!** **Make sure the bearing is clean inside.**

- Wipe the preservative oil off the bearing surface with a paper towel.
- It is necessary to lubricate all 4 rows of balls inside the bearing.
- Screw the tube into the applicator.
- Carefully slide the entire bearing onto the applicator.

## STEP 17 Bed mounts: parts preparation

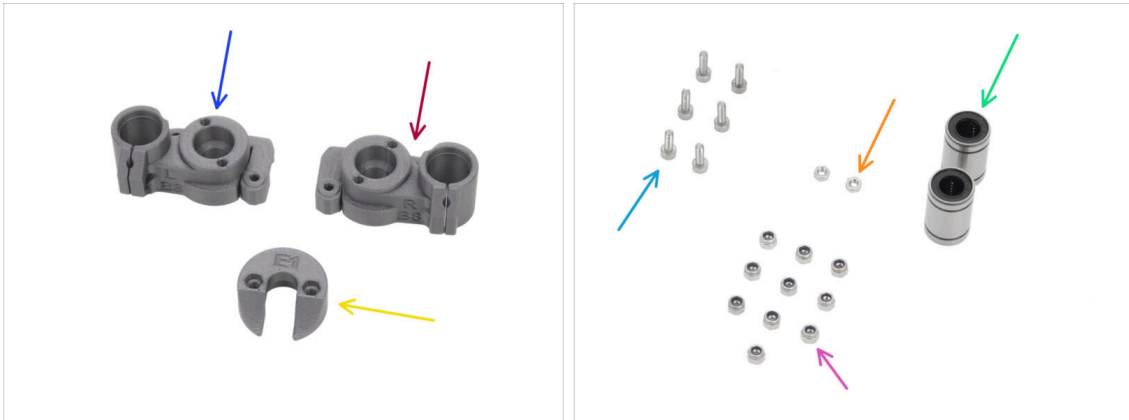

**■** For the following steps, please prepare:

- CORE-One-bed-mount-left (1x) *found in the Printed parts package*
- CORE-One-bed-mount-right (1x) *found in the Printed parts package*
- CORE-One-bed-spacer-rear (1x) *found in the Printed parts package*
- LM8UU bearing (2x) *freshly lubricated*
- M3x10 screw (6x)
- M3n nut (2x)
- M3nN nut (10x)

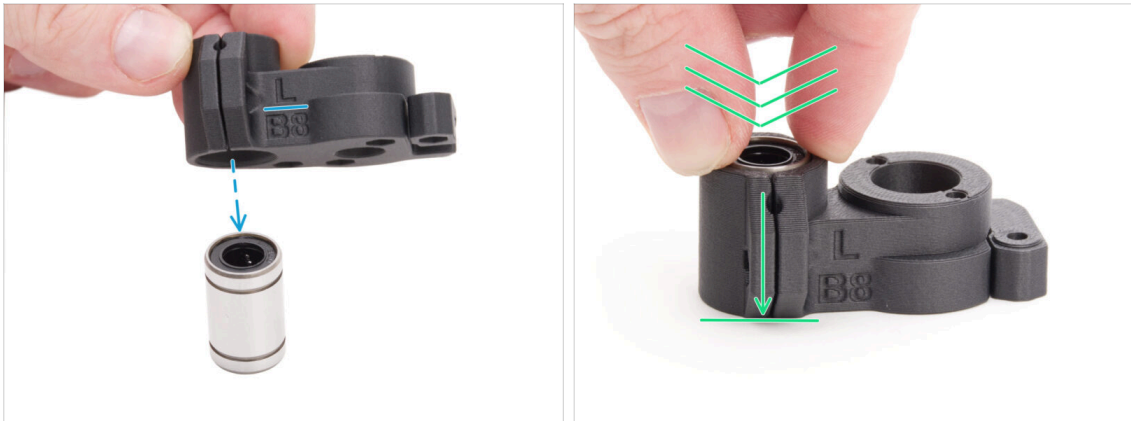
**STEP 18** Assembling the bed mounts

- Place the CORE-One-bed-mount-left onto the bearing, ensuring the correct orientation.
- Press the part onto the bearing, applying more force to ensure it moves all the way down. You will feel a click, indicating that the plastic part and bearing are correctly seated.
- ⚠ **The bearing must be fully enclosed within the part and must not protrude.**
- Follow the same procedure with CORE-One-bed-mount-right.

**STEP 19** Securing the bed mounts

- Insert one M3n nut into the CORE-One-bed-mount-left.
- Position the CORE-One-bed-mount-left according to the picture:
  - Position the bearing so that two ball rows face the bottom of the part, not just one.
- Keep the bearing in the position and secure it by inserting and tightening one M3x10 screw.
- ⚠ **Ensure that the top surface of the bearing is flush with the top surface of the plastic part.**
- Follow the same procedure with CORE-One-bed-mount-right.

## STEP 20 Bed mounts: inserting the nuts



- ◆ Insert four M3nN nuts into both bed mounts.
- ◆ Make sure they are inserted completely inside.

## STEP 21 Assembling the CORE-One-bed-spacer-rear



- ◆ Insert two M3nN nuts into the CORE-One-bed-spacer-rear.
- ◆ Insert the nuts down as much as possible.



Set the assembled part aside in a safe place. It will be needed in a later step.

## STEP 22 Installing the bed-mount-right



- ◆ Turn the heatbed carriage piece with the "forks" facing you and with the **expansion joints facing up**.
- ◆ Take the CORE-One-bed-mount-**right** part and slide it **under the right fork** - with the bearing on the right.
- ◆ Fix it with two M3x10 screws.

**STEP 23** Installing the bed-mount-left

- Take the One-bed-mount-**left** part and slide it **under** the **left** fork - with the bearing on the left.
- Fix it with two M3x10 screws.

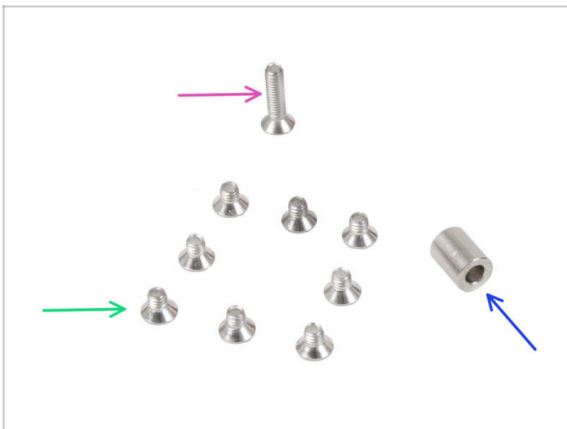
**STEP 24** Mounting the heatbed: parts preparation

- **For the following steps, please prepare:**
- M3x12bT screw (1x)
  - ⓘ The screw may also be labeled M3x12cT.
- Spacer 6x3.1x8 mm (1x) *from the disassembled printer*
- M3x4bT screw (8x)
  - ⓘ The screw may also be labeled M3x4cT.

## STEP 25 Mounting the heatbed

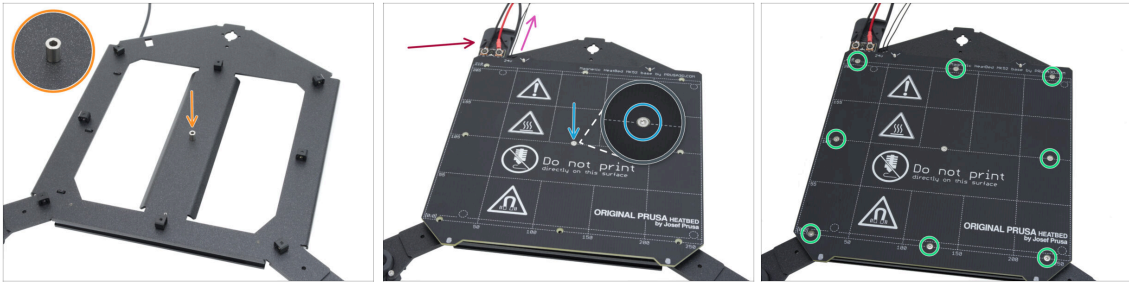

- ◆ Place the spacer onto the heatbed carriage on the side with the expansion joints and align it with the hole in the center.
- ◆ Put the heatbed on the heatbed carriage and secure it by the M3x12bT. **Do not fully tighten the screw yet.**
  - ◆ Make sure the heatbed thermistor cable (the thinnest pair) is routed alongside the heatbed power cables. Do not route it around or across any expansion joints.
- ⚠ **Ensure the correct orientation of the part. Use the heatbed cables as a guide.**
- ◆ Insert the M3x4bT screws into the remaining holes in the heatbed. **Do not fully tighten the screws yet.**

## STEP 26 Tightening the heatbed

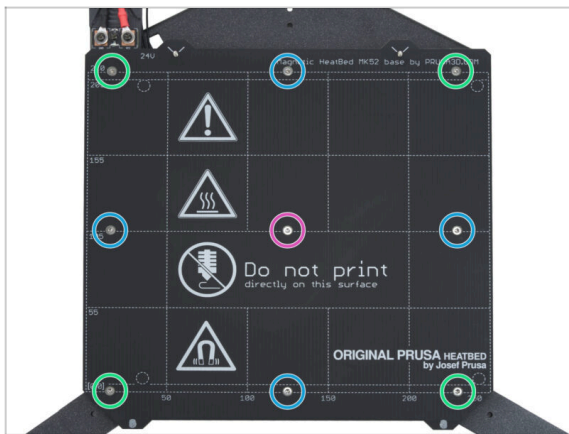

- ⚠ **IMPORTANT:** The heatbed must be tightened in a specific order. Repeat the sequence multiple times, ensuring the final tightening after at least two rounds.
- ◆ After all screws are in place, tighten them in the following sequence:
  - ◆ Center screw
  - ◆ First four screws (edges)
  - ◆ Last four screws (corners)
- ⚠ Tighten the screws gently, but firmly.

## STEP 27 Covering the cables: parts preparation

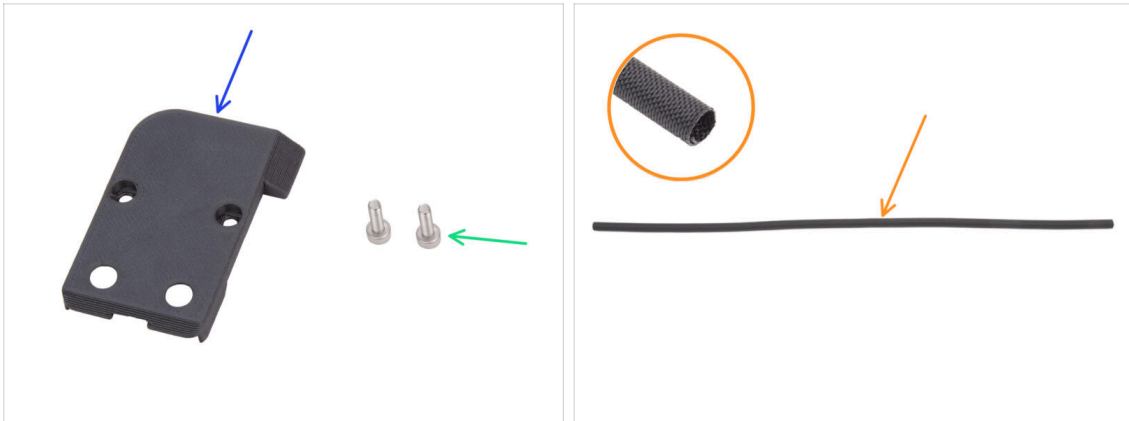

◆ For the following steps, please prepare:

- ◆ CORE-One-bed-cable-cover-top (1x) found in the Printed parts package
- ◆ M3x10 screw (2x)
- ◆ Textile sleeve 520 x 8 mm (1x) found in the Electronics & Chamber parts package

## STEP 28 Guiding the heatbed cables

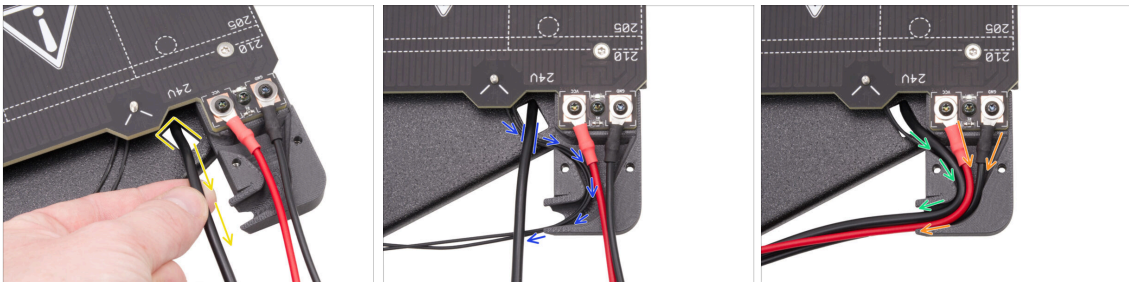

- ◆ Pull the RGB LED strip cable from the bottom through the rectangular cutout to the top.
- ◆ Guide the heatbed thermistor cable under the RGB LED cable, and insert the heatbed thermistor cable into the cable channel in the cable cover.
- ◆ Route the RGB LED strip cable through the cable channel.
- ◆ Guide the heatbed power cables through the cable channel.

## STEP 29 Covering the heatbed cables

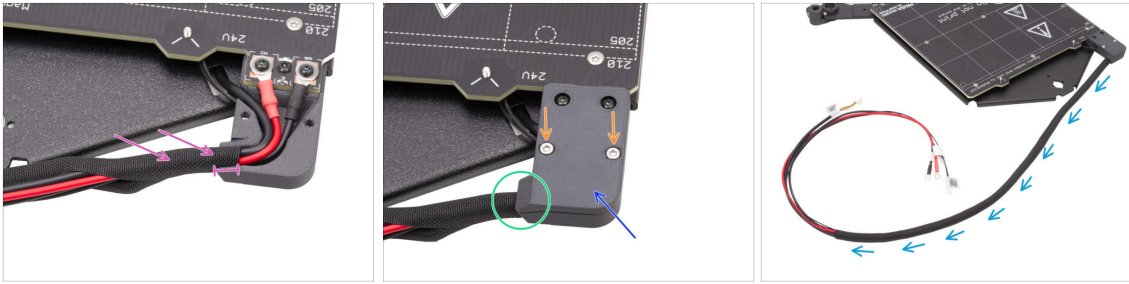

- ◆ Thread approximately 5 cm (2 in) of the textile sleeve onto the heatbed cable bundle and slide the textile sleeve 1 cm (0.39 in) into the cable channel.
- ◆ Attach the CORE-One-bed-cable-cover-top on the heatbed cables.
- ◆ Make sure the textile sleeve is still in place - inside the cable cover. **Do not pull on the textile sleeve.**
- ◆ Secure the top cover with two M3x10 screws.
- ◆ Wrap the rest of the textile sleeve around the cable bundle.

## STEP 30 Mounting the heatbed: parts preparation



- ◆ **For the following steps, please prepare:**
- ◆ Trapezoidal nut (3x)
  - ⓘ Two of these trapezoidal nuts are from the disassembled printer. The last one is in the Electronics and Chamber parts package.
- ◆ M3x18 screw (6x)

## STEP 31 Attaching the heatbed assembly

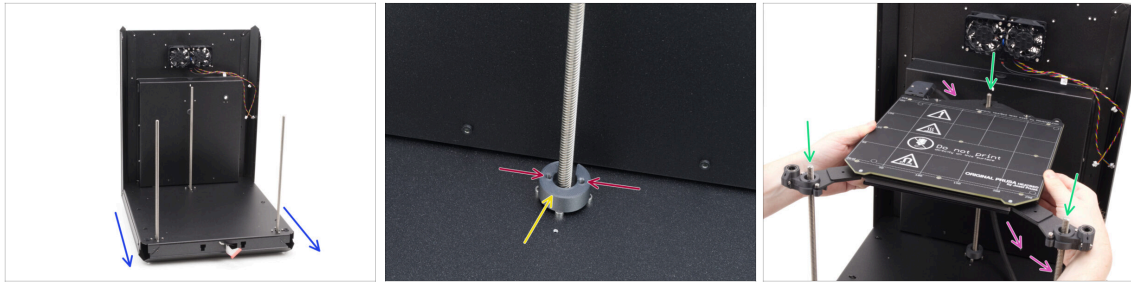

- Take the back and base assembly and orient the front side towards you.
- Place the CORE-One-bed-spacer-rear onto the rear motor screw heads, making sure it stays in place.
  - ⚠ Note the orientation of the part and holes as shown. The holes must be parallel to the motor screw heads.
- Very carefully thread the heatbed assembly onto the threaded rods of the Z motors, then gently lay it down onto the base.
  - ⚠ Keep in mind that there is a spacer on the rear motor. Avoid the spacer by the heatbed cable.
- The heatbed cable must run **under the heatbed and behind the rear motor.**

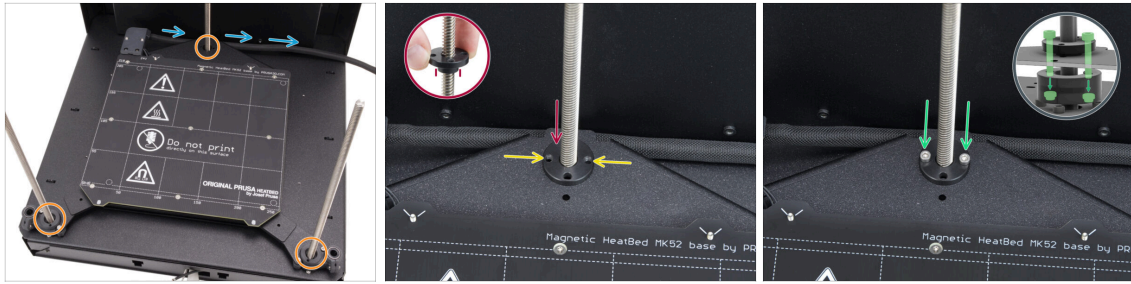
**STEP 32** Mounting the heatbed assembly: rear motor

- ◆ Ensure the heatbed assembly is seated correctly—all threaded rods pass through the correct holes.
- ◆ Double-check that the heatbed cable bundle (textile sleeve) runs properly—it **must go under the heatbed assembly** and **behind the threaded rod** of the rear motor.
- ◆ Manually thread the trapezoidal nut onto the rear Z motor. Screw the nut all the way down until it seats into the heatbed carriage.
  - ⚠ Ensure the correct orientation of the part. **The protruding section must face downwards.**
- ◆ Align the holes in the trapezoidal nut, carriage and bed-spacer-rear.
  - i It doesn't matter which holes you use in the trapezoidal nut.
  - i Tip: You can push a 1.5 mm Allen key through the holes in all the parts to align them.
- ◆ Secure the trapezoidal nut, heatbed carriage and bed-spacer-rear together with two M3x18 screws.

**STEP 33** Mounting the heatbed assembly: front motor left

- ◆ Manually thread the trapezoidal nut onto the **left** Z motor. Screw the nut all the way down until it seats into the plastic part.
  - ⚠ Ensure the correct orientation of the part. **The protruding section must face downwards.**
- ◆ Align the holes in the trapezoidal nut with those in the plastic part. Either pair of holes can be used.
- ◆ Secure all the part together with two M3x18 screws.

### STEP 34 Mounting the heatbed assembly: front motor right



- ◆ Manually thread the trapezoidal nut onto the **right** Z motor. Screw the nut all the way down until it seats into the plastic part.
- ⚠ Ensure the correct orientation of the part. **The protruding section must face downwards.**
- Align the holes in the trapezoidal nut with those in the plastic part. Either pair of holes can be used.
- Secure all the part together with two M3x18 screws.

### STEP 35 Attaching the heatbed cables I.

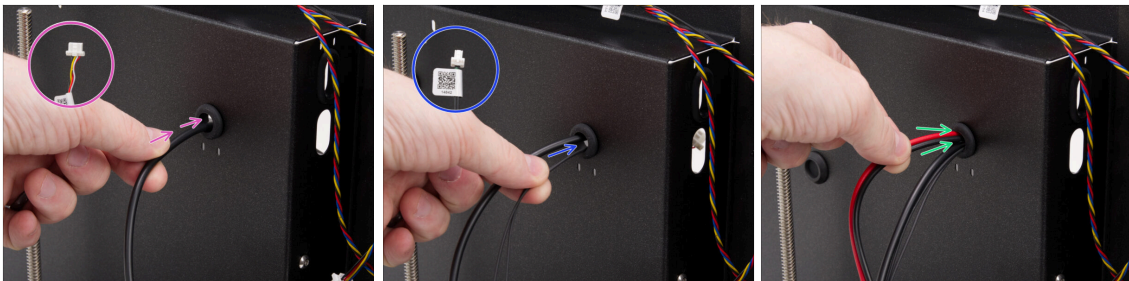

- ◆ Locate the grommet hole at the top right of the rear assembly and push the heatbed cables through in the following order:
  - ◆ Guide the RGB LED strip cable through the hole first.
  - ◆ Route the thermistor cable through.
  - ◆ Finally, insert both power cables through the hole.

### STEP 36 Attaching the heatbed cables II.

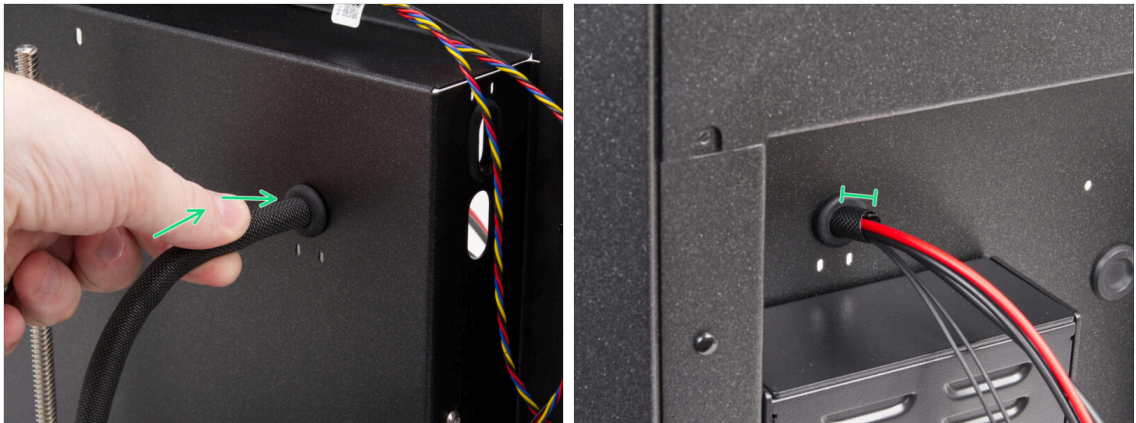

- Push the heatbed cables and the textile sleeve through the grommet hole.
- ⬛ No more than 1 cm (0.39 in) of the textile sleeve should protrude from the back side.

### STEP 37 Securing the heatbed cables: parts preparation

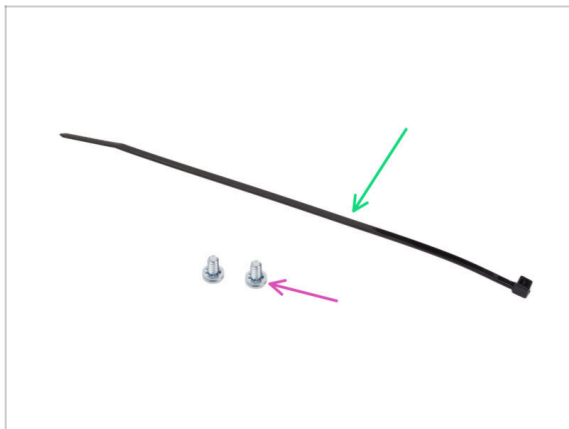

- ⬛ **For the following steps, please prepare:**
- Zip tie (1x)
- 6/32" terminal screw (2x)

### STEP 38 Securing the textile sleeve

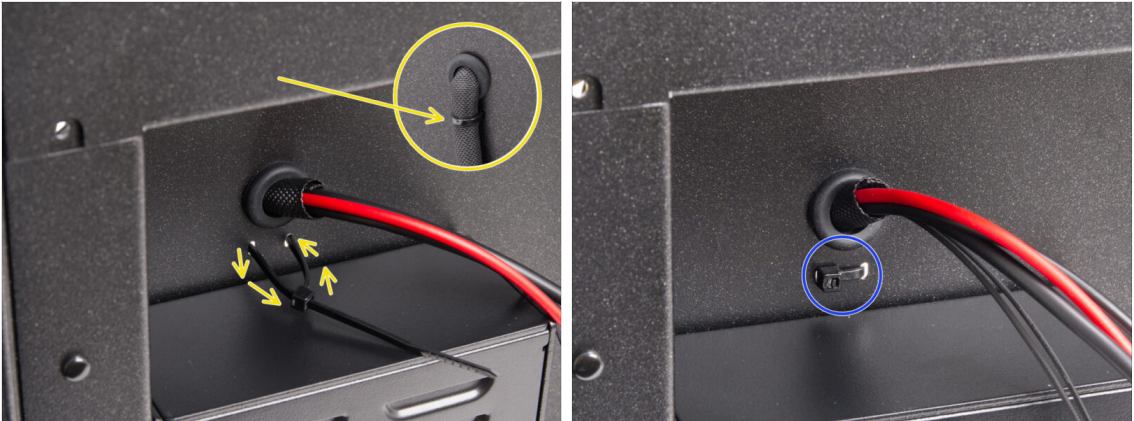

- Guide the zip tie through the two holes under the heatbed cables and make a loop around the heatbed cable bundle (textile sleeve) on the inside.
- Tighten the zip tie firmly and cut off the excess.

### STEP 39 Guiding the heatbed assembly cables

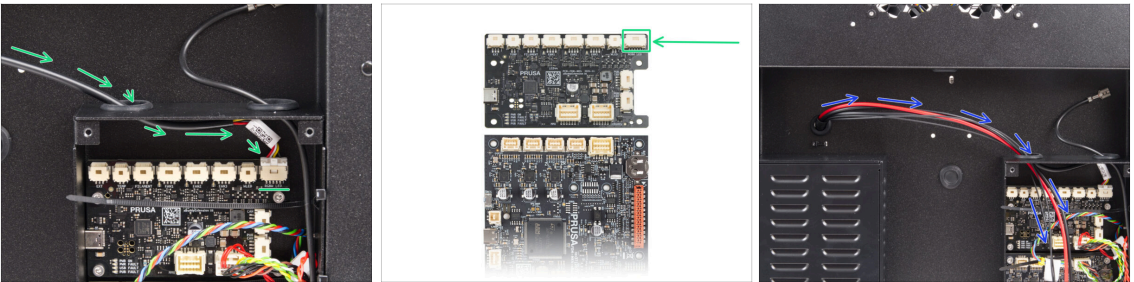

- Route the RGB LED strip cable through the left hole in the xBuddy box and connect it to the first slot on the xBuddy board labeled 'RGBW LED.'
- Connect it to the first slot from the right on the xBuddy extension board.
- Guide the heatbed power cables along with the thermistor through the left hole. Leave the cables hanging freely for now.

## STEP 40 Connecting the heatbed power cables

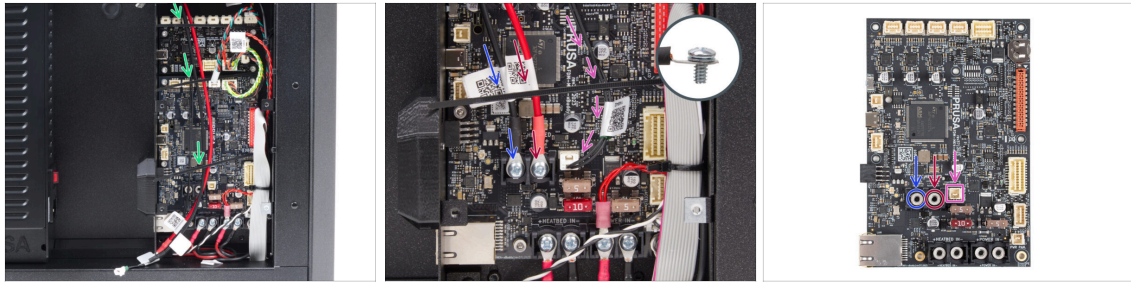

- ◆ Ensure that none of the heatbed cables run over the zip ties—they must be guided underneath.
- ◆ Using the 6-32 terminal screw, connect the **black** power cable to the **left** terminal on the xBuddy board. Tighten firmly.
- ◆ Using the 6-32 terminal screw, connect the **red** power cable to the **right** terminal. Tighten firmly.
- ◆ Plug the heatbed thermistor connector to the connector next to the power terminals.

## STEP 41 Haribo time

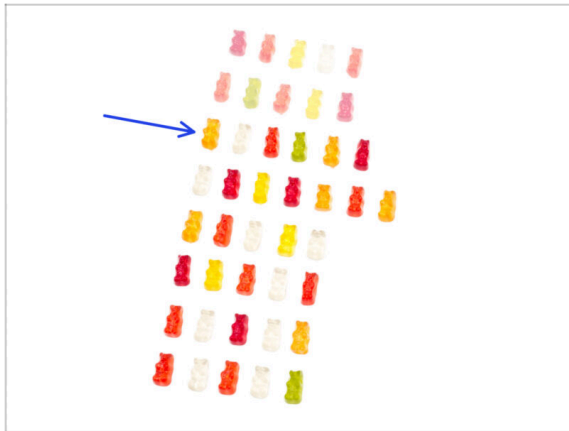

- ◆ Time for another quick energy boost!
- ◆ Eat the third row.
- ◆ With one extra treat. You deserve it!

## 5. CoreXY assembly

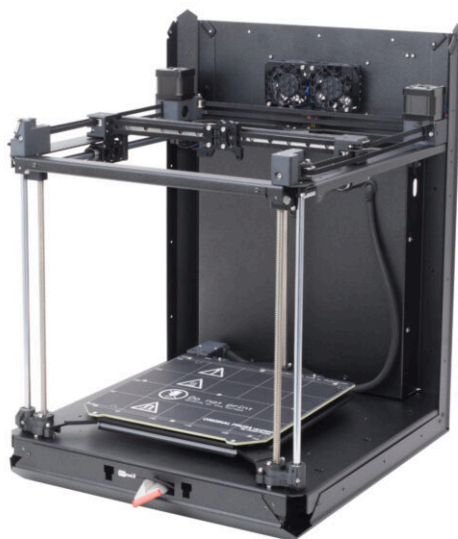

## STEP 1 Tools necessary for this chapter

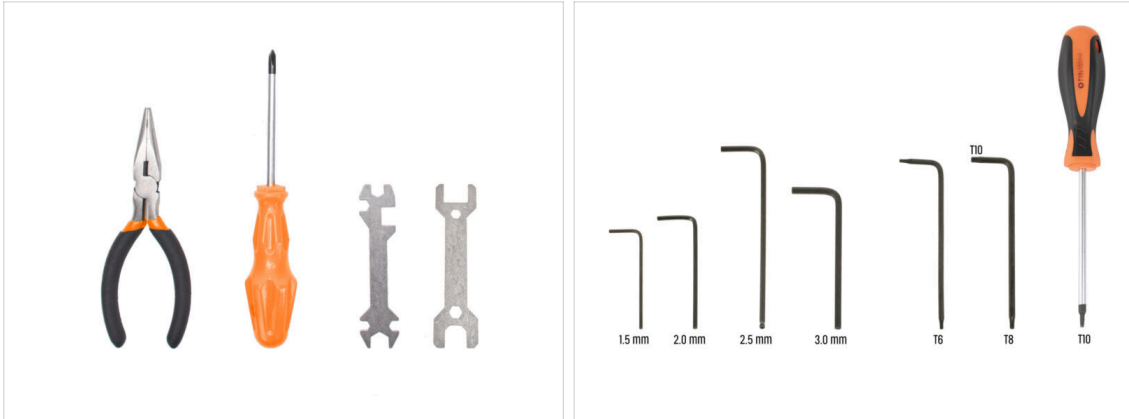

● **For this chapter, please prepare:**

- Needle-nose pliers
- 2.0mm Allen key
- 2.5mm Allen key
- T10 torx key / T10 torxy screwdriver

## STEP 2 Rod holders: parts preparation

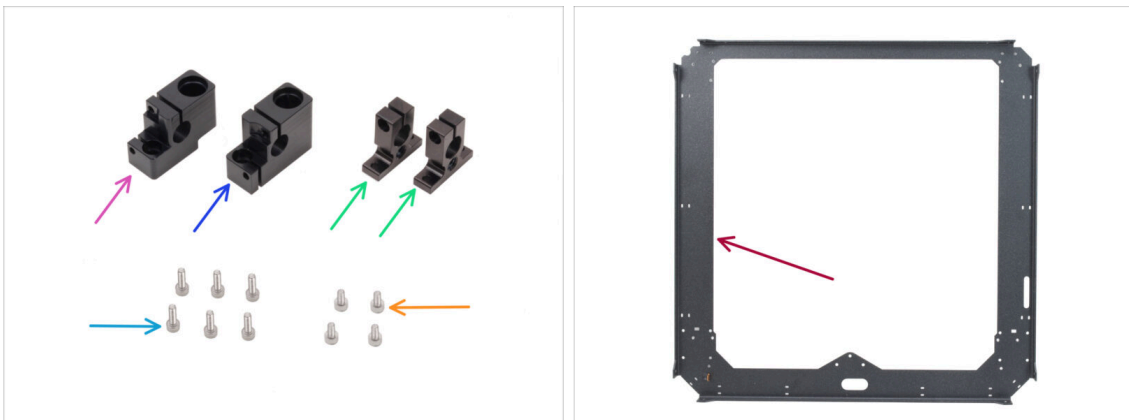

● **For the following steps, please prepare:**

- Rod holder left (1x) *found in the CORE XY parts + hinges + HB set package*
- Rod holder right (1x) *found in the CORE XY parts + hinges + HB set package*
- Rod holder rear (2x) *found in the CORE XY parts + hinges + HB set package*
- M3x10 screw (6x)
- M3x6 screw (4x)
- CoreXY plate (1x) *found in the Metal parts 1/3 package*

### STEP 3 Assembling the rod holders

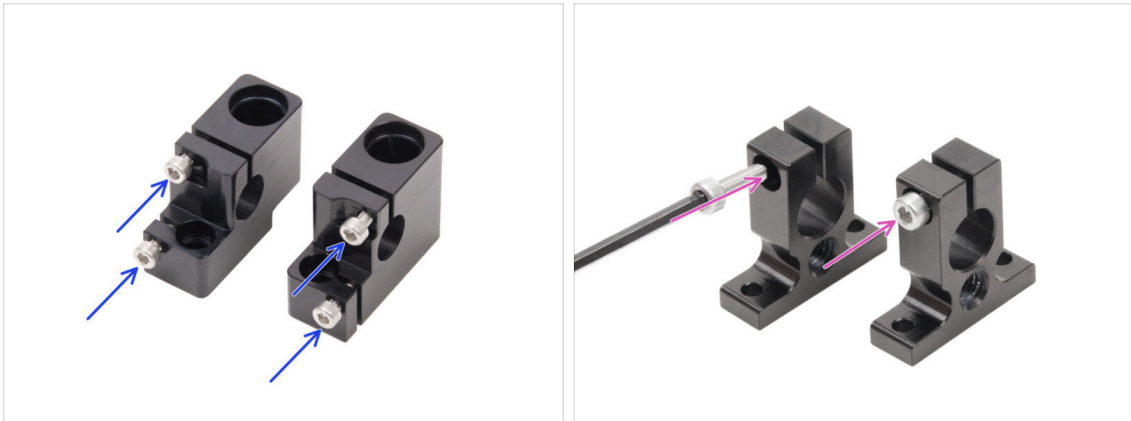

- ◆ Insert two M3x10 screws into the Rod holder left and two into the Rod holder right.
  - ◆ **Do not tighten them completely, a few turns are enough for now.**
  - ◆ Insert one M3x10 screw into each Rod holder rear. Insert from the **side with the screw head hole**.
    - ◆ **Do not tighten them completely, a few turns are enough for now.**

### STEP 4 Preparing the front rod holders



- ◆ Place the CoreXY plate as shown - the **bent parts of the plate must point upwards**.
  - ◆ Divide the Rod holder left and the Rod holder right into the sides of the front:
    - ⚠ **Ensure you are preparing the correct part for the correct side. Use the chamfers on both parts as a reference for alignment.**
    - ◆ **Rod holder left**
    - ◆ **Rod holder right**

## STEP 5 Installing the front rod holders



- ◆ Place the Rod holder left to the left front corner on the corresponding threaded holes.
- ◆ Secure it with two M3x6 screws.
- ◆ Place the Rod holder right to the right front corner on the corresponding threaded holes.
- ◆ Secure it with two M3x6 screws.

## STEP 6 XY carriage: parts preparation

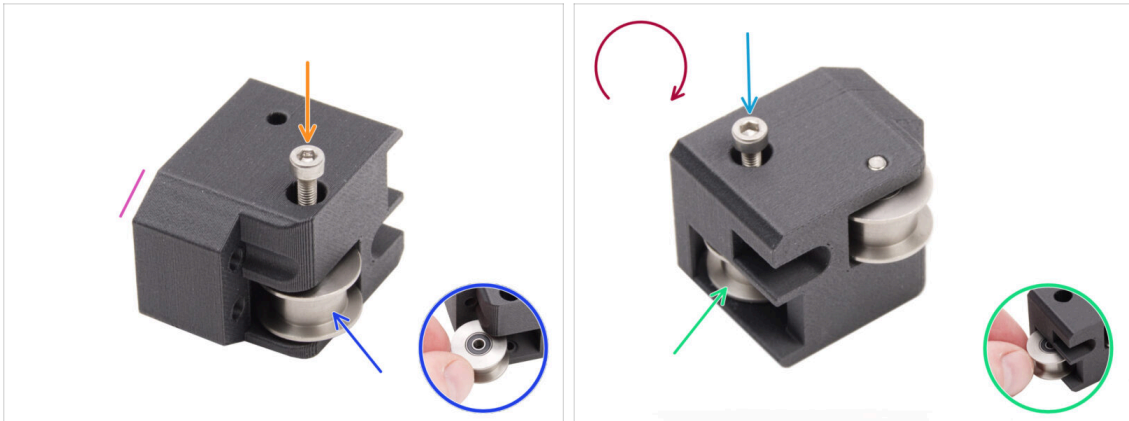

- ◆ **For the following steps, please prepare:**
- ◆ Linear holder left (1x) *found in the Metal parts 1/3 package*
- ◆ Linear holder right (1x) *found in the Metal parts 1/3 package*
- ◆ XY-carriage (2x) *found in the Printed parts package (appearance may vary, the assembly process is the same)*
- ◆ LM10LUU linear bearing (2x) *found in the CORE XY parts + hinges + HB set package*
- ◆ GT2-20 Idler pulley (4x) *found in the Electronics & Fasteners package*
- ◆ M3x8rT black screw (8x)
- ◆ M3x18 screw (10x)

**STEP 7** Assembling the XY-carriages

- ◆ Take one of the XY-carriage and orient it as shown. Use the beveled side as a guide.
- ◆ Insert the GT2-20 Idler pulley into the XY-carriage.
- ◆ Push one M3x18 screw through the pulley and tighten it completely down.
- ◆ Turn the part upside down.
- ◆ Insert another GT2-20 Idler pulley into the XY-carriage.
- ◆ Secure it with the M3x18 screw. Tighten it completely down.
- ◆ Repeat the same procedure with the second XY-carriage.

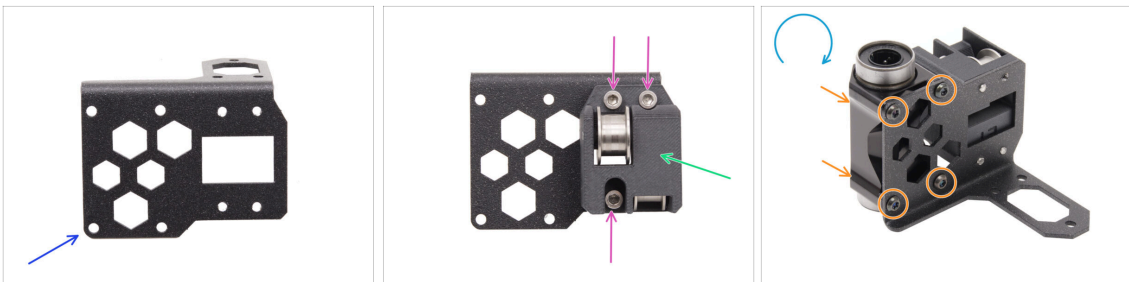
**STEP 8** Assembling the linear holder left

- ◆ Prepare the Linear holder **left** and position it as in the picture.
- ◆ Attach one of the XY-carriages to the Linear holder.
- ◆ Install it to the Linear holder with three M3x18 screws.
- ◆ Turn the Linear holder upside down.
- ◆ From the XY-carriage side, attach the LM10LUU linear bearing to the holder and secure it with four M3x8rT screws.

## STEP 9 Assembling the linear holder right

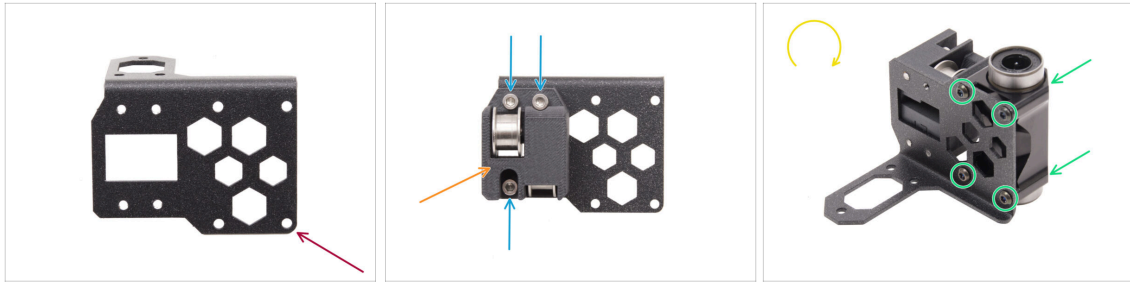

- ◆ Prepare the Linear holder **right** and position it as in the picture.
- ◆ Attach one of the XY-carriages to the Linear holder.
- ◆ Install it to the Linear holder with three M3x18 screws.
- ◆ Turn the Linear holder upside down.
- ◆ From the XY-carriage side, attach the LM10LUU linear bearing to the holder and secure it with four M3x8rT screws.

## STEP 10 Attaching the linear holder assemblies

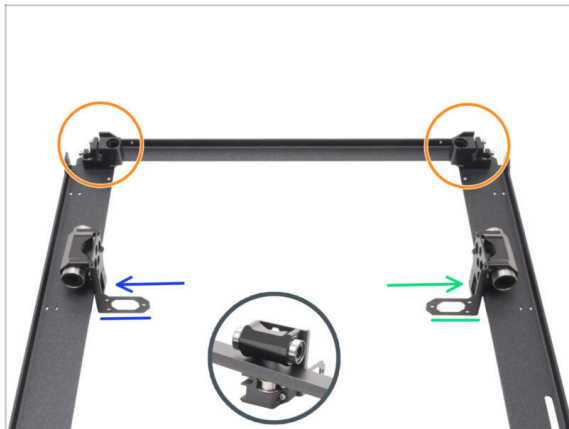

- ◆ Position the CoreXY plate as shown in the picture, ensuring the front rod holders are facing up.
- ◆ Slightly lift the CoreXY plate and from the plate's inner side loosely attach the Linear holder of the assemblies.
  - ◆ **Linear holder left**
  - ◆ **Linear holder right**
- ⓘ The linear holders are now only loosely seated.

## STEP 11 Smooth rods INFO

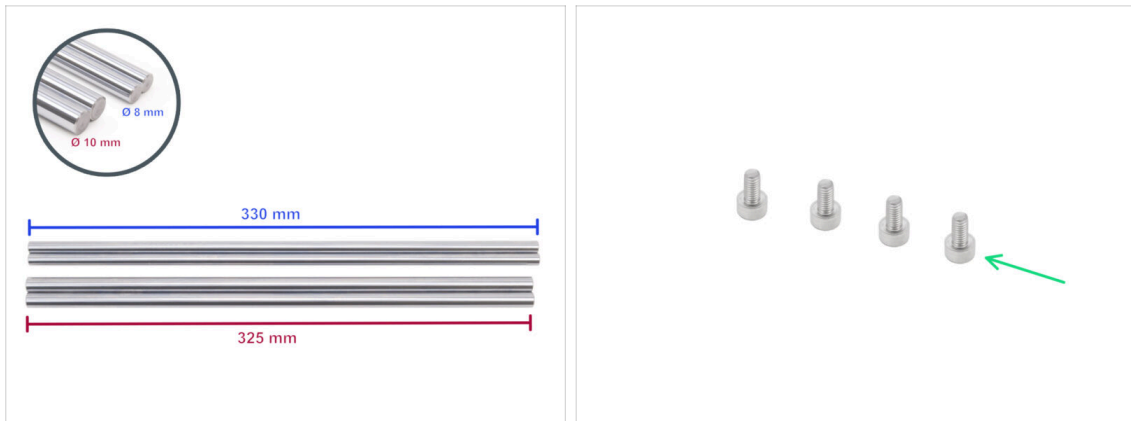

- ◆ The printer requires different smooth rod sizes. Ensure you have the correct ones:
  - ◆ Smooth rod 330 x 8 mm (2x)
  - ◆ Smooth rod 325 x 10 mm (2x)  
*originally from the Z-axis,*  
**are needed for the following steps.**
- ◆ **Also prepare:**
  - ◆ M3x6 screw (4x)

## STEP 12 Mounting the smooth rods



- ◆ Slide both rear rod holders onto both 10mm smooth rods.
- ◆ Line up the ends of the rods with the holders.
- ◆ Push both 10mm smooth rods through the LM10LUU bearing to the front rod holders.
  - ◆ Make sure the screws on the rear rod holders are pointing out of the frame.
- ◆ Line up the front end of the 10mm smooth rods with the front rod holders.

## STEP 13 Securing the rear rod holders

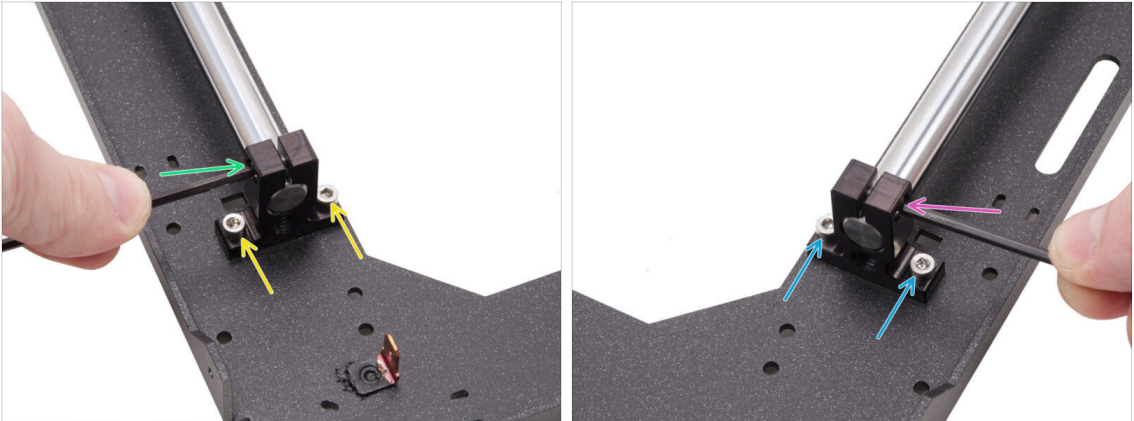

- Line up the left rear rod holder with the threaded holes in the plate.
- Fix it with two M3x6 screws.
- Firmly tighten the screw in the rod holder.
- Line up the right rear rod holder with the threaded holes in the plate.
- Fix it with two M3x6 screws.
- Firmly tighten the screw in the rod holder.

## STEP 14 Securing the front rod holders

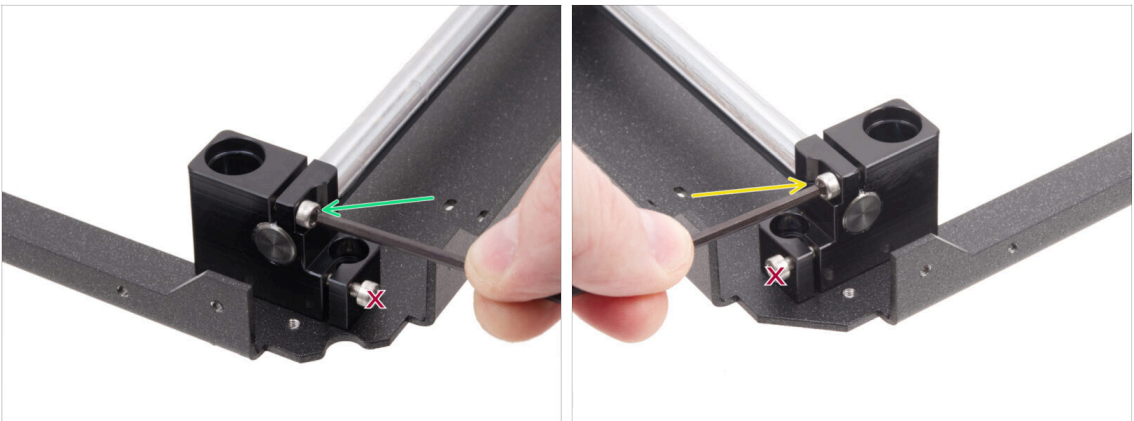

- Focus on the front left holder (now on the right) and secure the rod by tightening the screw in the holder.
- ⚠ **Do not tighten the bottom screw.**
- Focus on the front right holder (now on the left) and secure the rod by tightening the screw in the holder.
- ⚠ **Do not tighten the bottom screw.**

## STEP 15 Motor mounts: parts preparation

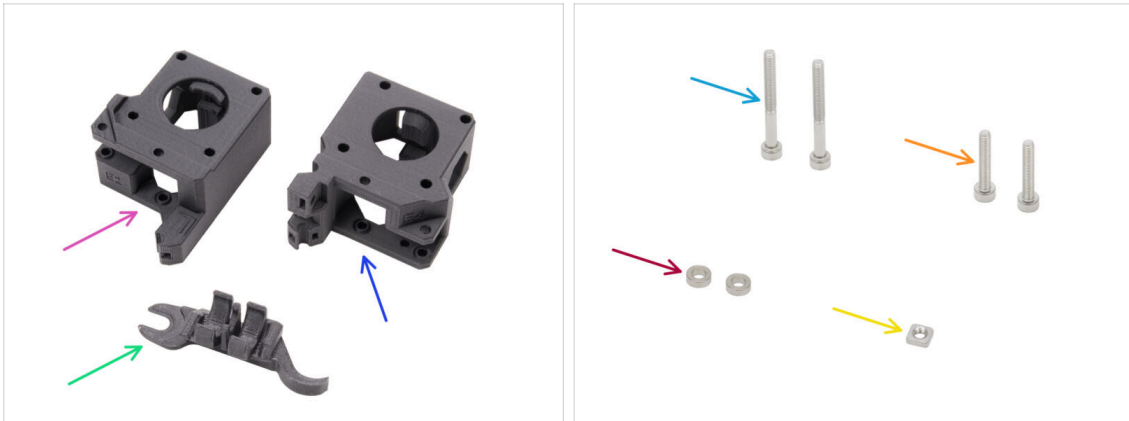

◆ **For the following steps, please prepare:**

- ◆ XY-motor-mount-left (1x) *found in the Printed parts package*
- ◆ XY-motor-mount-right (1x) *found in the Printed parts package*
- ◆ Assembly-multi-tool (1x) *you already used*
- ◆ M3x30 screw (2x)
- ◆ M3x18 screw (2x)
- ◆ Spacer 3.2/6x2 (2x) *found in the Electronics & Fasteners package*
- ◆ M3nS nut (1x)

ⓘ The list continues in the next step...

## STEP 16 Motor mounts: part preparation

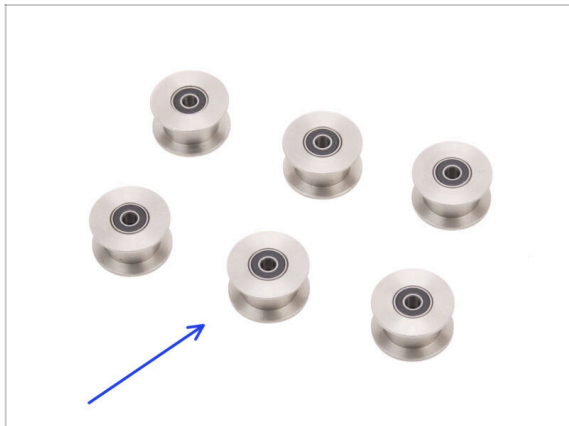

- ◆ GT2-20 Idler pulley (6x) *found in the Electronics & Fasteners package*

**STEP 17** Assembling the XY-motor-mount-right I.

- ◆ Insert one pulley into the lower position in the Assembly-multi-tool.
- ◆ Insert the spacer 3.2 on the pulley.
- ◆ Insert the second pulley into the Assembly-multi-tool.
- ◆ Insert the whole assembly into the XY-motor-mount-right as shown. Note the beveled corner.

**STEP 18** Assembling the XY-motor-mount-right II.

- ◆ Align the holes in both parts and insert the M3x30 screw. Slowly and carefully tighten the screw.
  - ⓘ The plastic part has no pre-cut thread, so the screw will create it as you tighten. Slight resistance is expected.
- ◆ **Stop tightening once the M3x30 screw head reaches the XY-motor-mount. Do not overtighten the screw!**
- ◆ Remove the Assembly-multi-tool.
- ◆ Insert another pulley into the XY-motor-mount-right.
- ◆ Secure it with M3x18 screw. Do not overtighten the screw.
- ◆ Insert the M3nS nut into the XY-motor-mount-right.

## STEP 19 Assembling the XY-motor-mount-left I.



- ◆ Insert one pulley into the lower position in the Assembly-multi-tool.
- ◆ Insert the spacer 3.2 on the pulley.
- ◆ Insert the second pulley into the Assembly-multi-tool.
- ◆ Insert the whole assembly into the XY-motor-mount-left.
- ◆ Position the part according to the picture. Note the bevel next to the screw hole.

## STEP 20 Assembling the XY-motor-mount-left II.

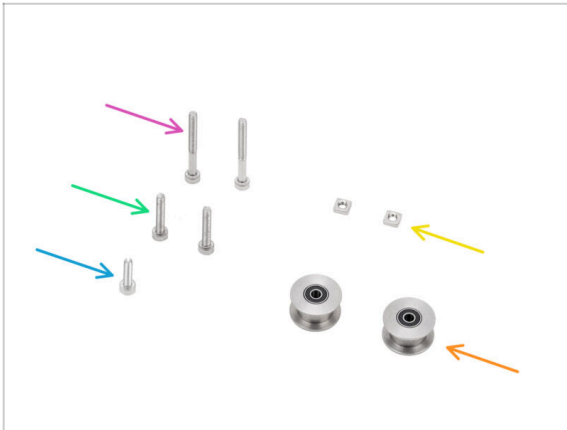

- ◆ Align the holes in both parts and insert the M3x30 screw. Slowly and carefully tighten the screw.
- ⓘ The plastic part has no pre-cut thread, so the screw will create it as you tighten. Slight resistance is expected.
- ◆ **Stop tightening once the M3x30 screw head reaches the XY-motor-mount. Do not overtighten the screw!**
- ◆ Remove the Assembly-multi-tool.
- ◆ Insert another pulley into the part.
- ◆ Secure it with M3x18 screw. Do not overtighten the screw.

**STEP 21** Belt tensioners: parts preparation I.

⬛ For the following steps, please prepare:

🟠 GT2-20 Idler pulley (2x) *you have removed from the MK4S*

🟡 M3x30 screw (2x)

🟢 M3x18 screw (2x)

🟠 M3x12 screw (1x)

🟡 M3nS nut (2x)

ⓘ The list continues in the next step...

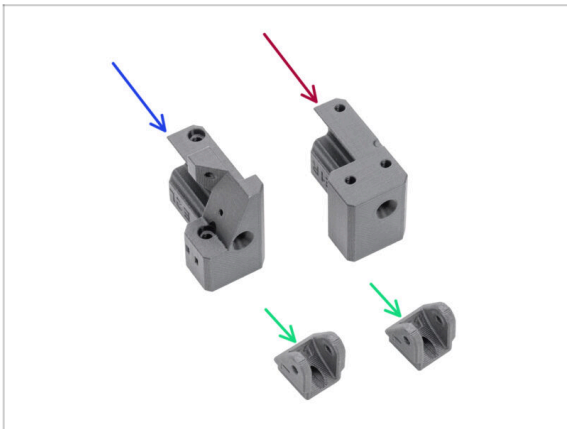
**STEP 22** Belt tensioners: parts preparation II.

⬛ For the following steps, please prepare:

🟠 Belt-tensioner-left (1x) *found in the Printed parts package*

🟡 Belt-tensioner-right (1x) *found in the Printed parts package*

🟢 Belt-tensioner-pulley (2x) *found in the Printed parts package*

## STEP 23 Preparing the tensioner pulleys

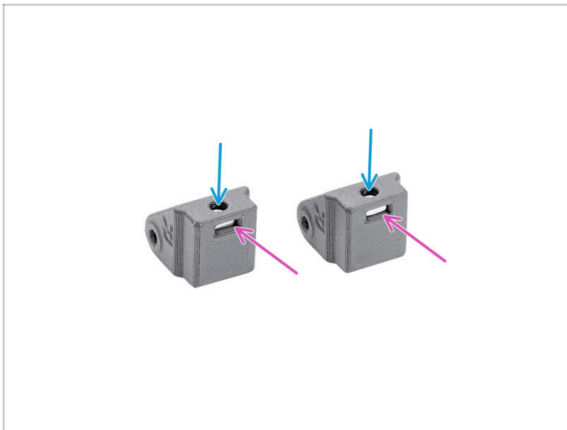

- ◆ Insert one M3nS nut into each Belt-tensioner-pulley.
- ◆ Make sure the nuts are correctly inserted into the parts. The holes in the nuts and the parts **must be aligned**.
- ◆ Keep both parts in this position.

## STEP 24 Assembling the belt tensioner left I.



- ◆ Apply a small amount of Prusa lubricant to the tip of both M3x30 screws.
- ◆ Spread the lubricant evenly around the entire thread.
  - ⓘ Tip: Use the tip of a zip tie to spread the lubricant.
- ◆ Slide the Belt-tensioner-left onto the Belt-tensioner-pulley.
  - ◆ **Ensure the parts are oriented correctly**, as shown.
- ◆ Insert the M3x30 screw through the Belt-tensioner-left into the Belt-tensioner-pulley. **Do not tighten completely!** 3-4 turns are sufficient.

**STEP 25** Assembling the belt tensioner left II.

- Insert the GT2-20 Idler pulley into the Belt-tensioner-pulley.
- Secure it with the M3x18 screw.
  - ⓘ The plastic part has no pre-cut thread, so the screw will create it as you tighten. Slight resistance is expected.
- Insert the M3x12 screw into the Belt-tensioner-left. Tighten slightly—five turns are enough. It must not protrude through the other side.
  - ⓘ Note: This screw, referred to as the tensioning screw, will later be used to adjust the door sensor.

**STEP 26** Assembling the belt tensioner right

- Slide the Belt-tensioner-**right** onto the Belt-tensioner-pulley.
  - **Ensure the parts are oriented correctly**, as shown.
- Insert the M3x30 screw through the Belt-tensioner-right into the Belt-tensioner-pulley. **Do not tighten completely!** 3-4 turns are sufficient.
- Insert the GT2-20 Idler pulley pulley into the Belt-tensioner-pulley-right.
- Secure it with the M3x18 screw.
  - ⓘ The plastic part has no pre-cut thread, so the screw will create it as you tighten. Slight resistance is expected.

## STEP 27 Installing the belt tensioners: parts preparation

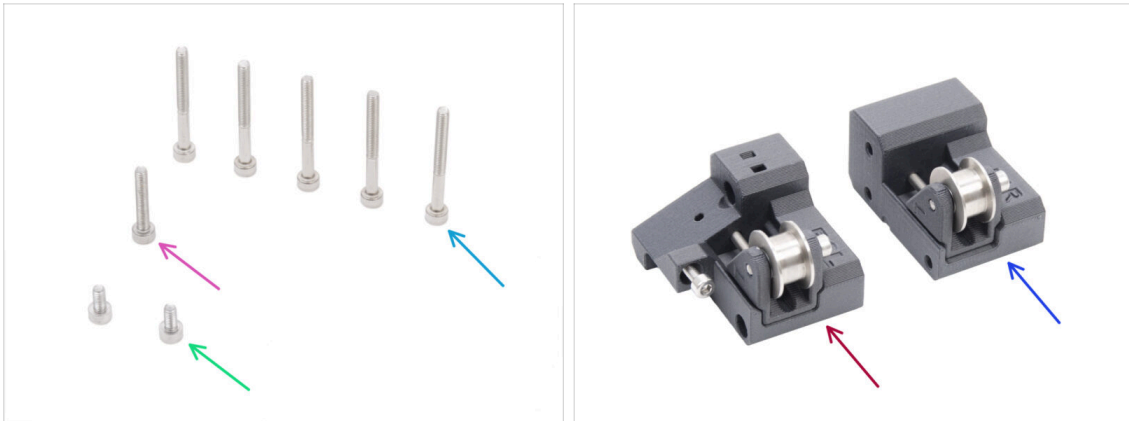

● For the following steps, please prepare:

- M3x30 screw (5x)
- M3x18 screw (1x)
- M3x6 screw (2x)
- Belt tensioner left assembly (1x) *you assembled earlier*
- Belt tensioner right assembly (1x) *you assembled earlier*

## STEP 28 Installing the motor mount left

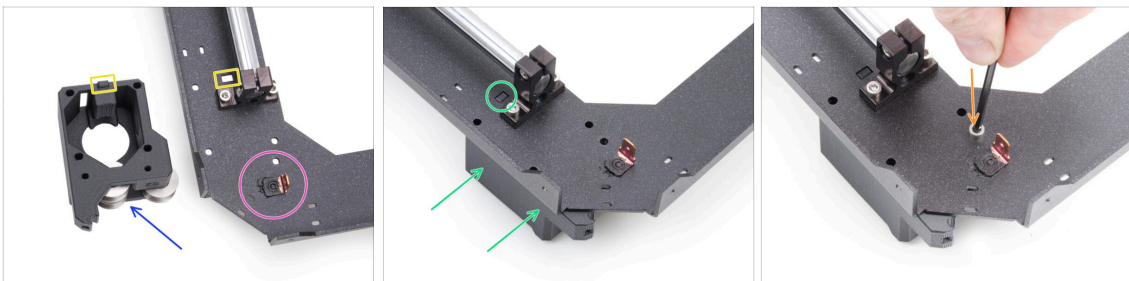

- Locate the corner of the CoreXY plate with the Faston connector on it. It is on the underside of the assembly.
- Position the motor-mount-**left** on the CoreXY plate as shown in the picture.
- Note the rectangular protrusion on the motor-mount-left and the rectangular cutout on the CoreXY plate.
- Slide the motor-mount-left under the CoreXY plate, ensuring the rectangular protrusion fits into the cutout.
- Align the holes in both parts and secure them with an M3x6 screw in the designated hole

## STEP 29 Installing the motor mount right

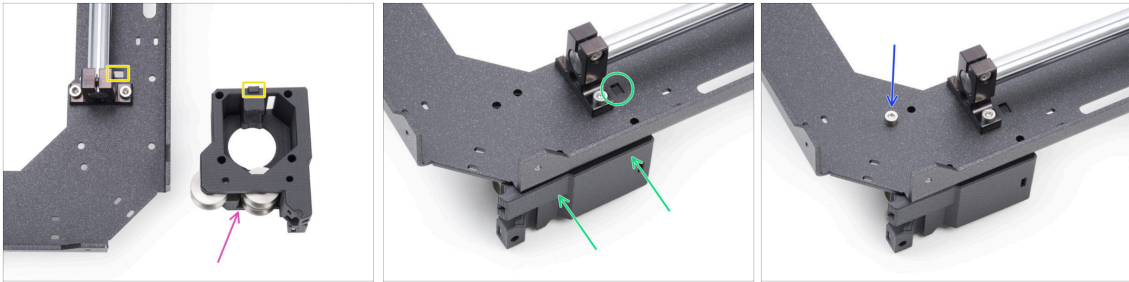

- ◆ Position the motor-mount-**right** on the CoreXY plate as shown in the picture.
- ◆ Note the rectangular protrusion on the motor-mount-right and the rectangular cutout on the CoreXY plate.
- ◆ Slide the motor-mount-right under the CoreXY plate, ensuring the rectangular protrusion fits into the cutout.
- ◆ Align the holes in both parts and secure them with an M3x6 screw in the designated hole

## STEP 30 Installing the belt-tensioner-left

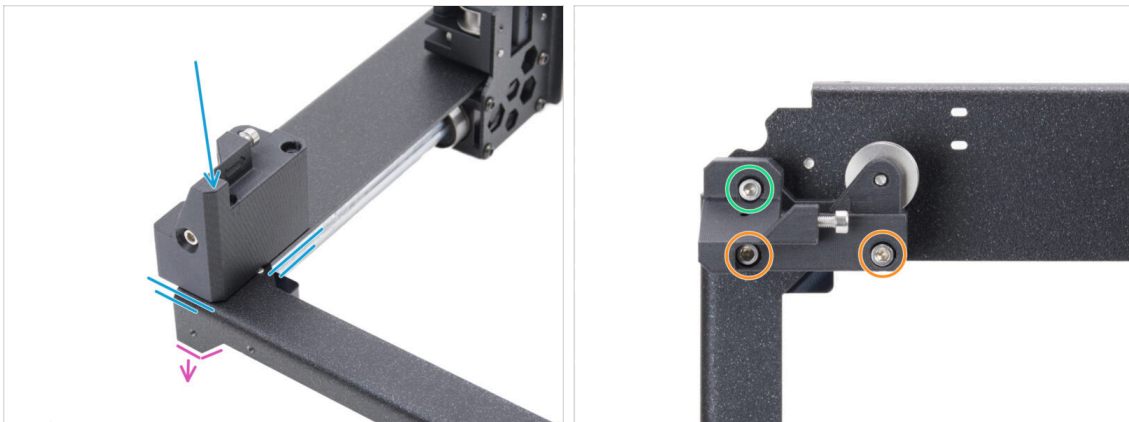

- ◆ Turn the CoreXY assembly upside down so that the bent parts face downward. Focus on the front left corner on the assembly.
- ◆ Place the belt-tensioner-**left** assembly in the front left corner of the CoreXY plate. Align it with the front and inner side edges.
  - ◆ Line up the holes in both parts.
  - ◆ Secure the part with two M3x30 screws.
  - ◆ Insert and tighten one M3x18 screw.

## STEP 31 Installing the belt-tensioner-right

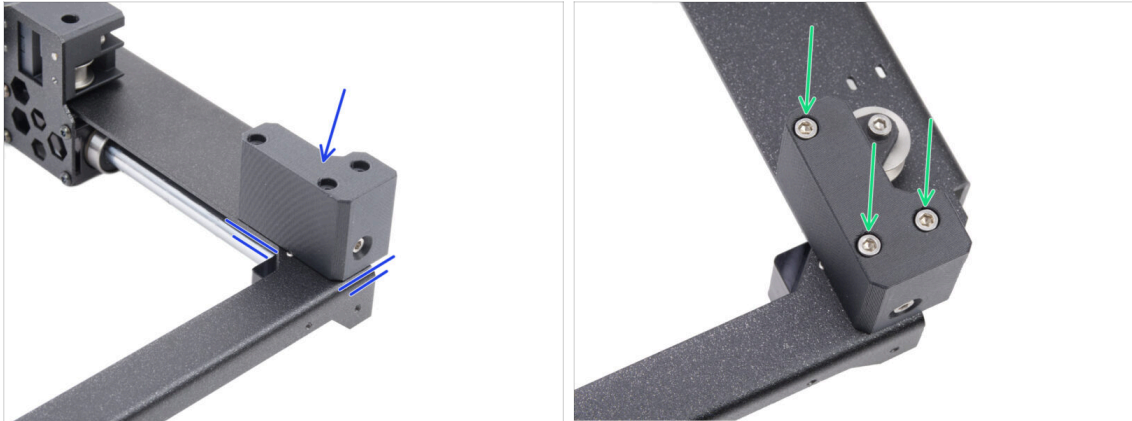

- Place the belt-tensioner-**right** assembly in the front right corner. Align it with the front and inner side edges.
- Line up the holes in both parts.
- Secure the part with three M3x30 screws.

## STEP 32 Linear rail: parts preparation

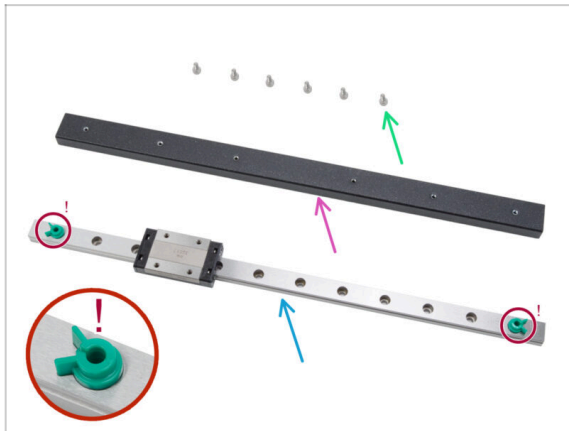

- For the following steps, please prepare:
- M3x6 screw (6x)
- Linear rail beam (1x) found in the Metal parts 3/3 package
- Linear rail (1x) found in the Electronics & Chamber parts package
- ⚠ **Under no circumstances remove the green anti-ejection safety pins.** Wait for the prompt in the instructions.
- Piece of cloth or a paper towels to wipe the preservative lubricant from the linear guide.

## STEP 33 Attaching the linear rail

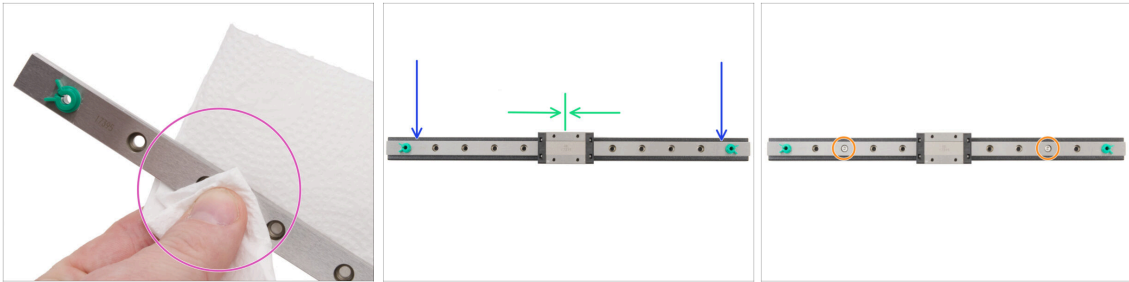

- ⚠ Under no circumstances remove the green anti-ejection safety pins. Wait for the prompt in the instructions.**
- 🟡 Immediately after removing the linear guide from the package, wipe off the preservative lubricant with a paper towel.
  - 🟢 Place the linear rail on the linear rail beam and line up the holes in both parts.
  - 🟠 Insert and slightly tighten two M3x6 screws into the third holes from both ends.
  - 🟢 Move the linear carriage approximately to the center of the rail.

## STEP 34 Securing the linear rail

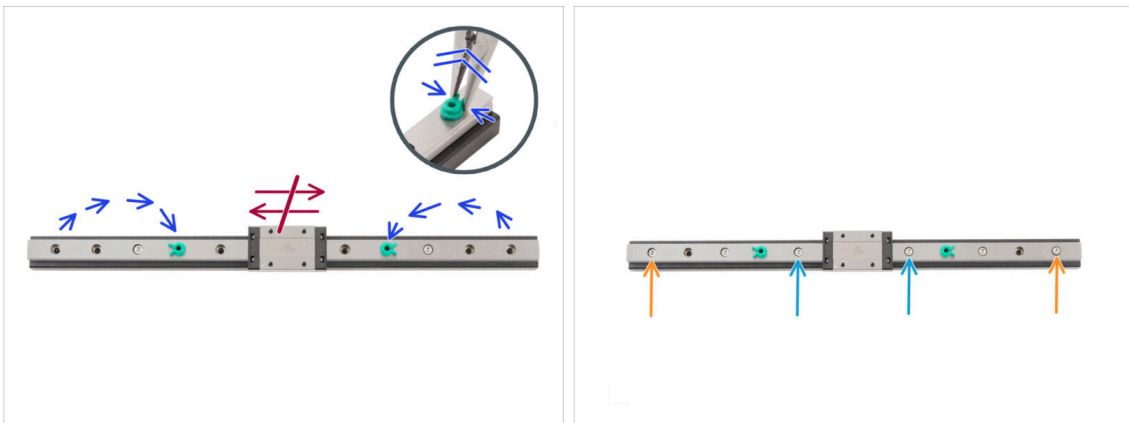

- ⚠ Do not move the linear carriage in any way in this step.**
- 🟢 Relocate the safety pins from each end to the fourth holes from the ends of the linear rail.
    - 🔧 Gently squeeze the safety pin with needle-nose pliers and pull it out.
  - 🟢 Insert two M3x6 screws into the fifth holes from the ends of the rail. **Tighten just slightly.**
  - 🟠 Insert two M3x6 screws into the first holes in the rail. **Tighten just slightly.**
- ⚠ Do not remove the safety pins from the rail.**

## STEP 35 Installing the linear rail: parts preparation

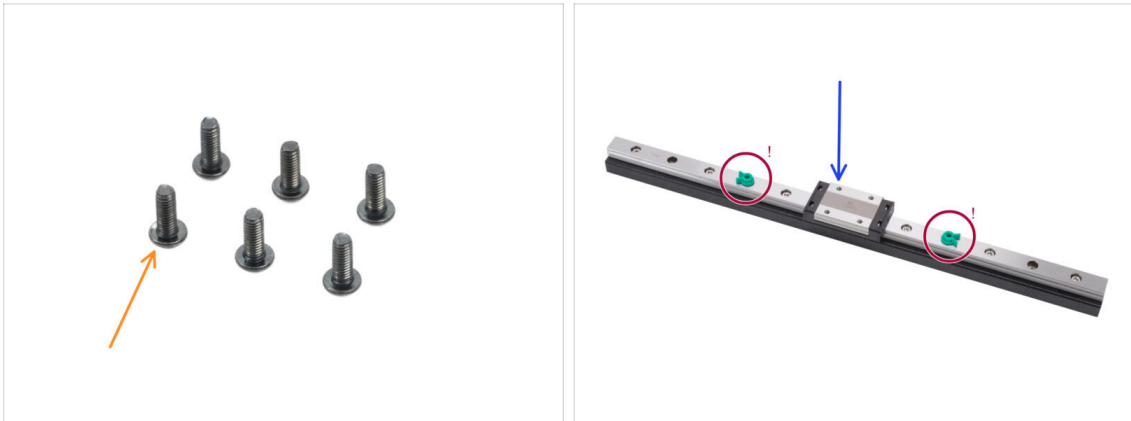

◆ For the following steps, please prepare:

◆ M3x8rT screw (6x)

ⓘ There are both M3x8rT and M3x8 screws in the kit. Make sure you have prepared the correct ones.

◆ Linear rail assembly (1x) you assembled earlier

⚠ Do not remove the safety pins.

## STEP 36 Installing the linear rail assembly



◆ Position the assembly with the motor mounts facing you.

◆ Move both linear holders approximately to the center of the Y-axis.

◆ Attach the linear rail assembly to the holders from the front side of the assembly.

◆ Secure it with three M3x8rT screws from the back side on both the left and right sides.

### STEP 37 Linear rail: removing the safety pins

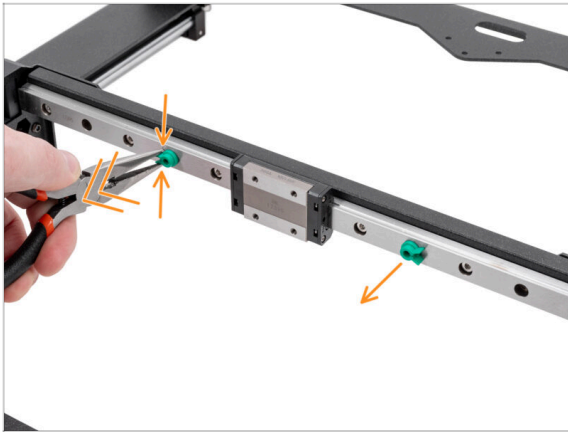

- 🟡 Gently squeeze both safety pins with needle-nose pliers and pull them out of the linear rail.
- ⓘ You can discard the safety pins as they are no longer needed.

### STEP 38 Bed-stop: parts preparation

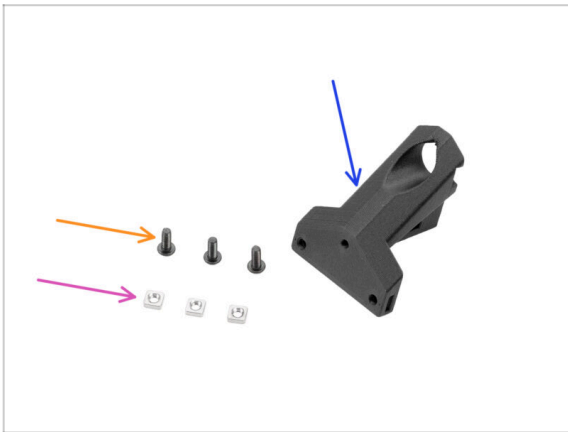

- ⬛ **For the following steps, please prepare:**
- 🟡 Bed-stop-rear (1x) *found in the Printed parts package*
- 🟡 M3nS nut (3x)
- 🟡 M3x8rT screw (3x)

### STEP 39 Assembling the bed-stop



- 🟡 Insert two M3nS nuts into the bed-stop from one side.
- 🟡 Insert one M3x8rT screw into the bed-stop from the other side.

**STEP 40** Mounting the bed-stop

- ◆ Position the CoreXY assembly as shown, ensuring the motor mounts face upwards.
- ◆ Focus on the triangle protrusion on the metal part.
- ◆ Insert the bed-stop-rear **under** the protrusion at the back of the CoreXY plate.
- ◆ Align all three holes in both parts.
- ◆ Secure both parts together with three M3x8rT screws.
- ⓘ The upper screw is screwed into plastic with no pre-cut thread. It cuts the thread as it's tightened. Slight resistance is expected.

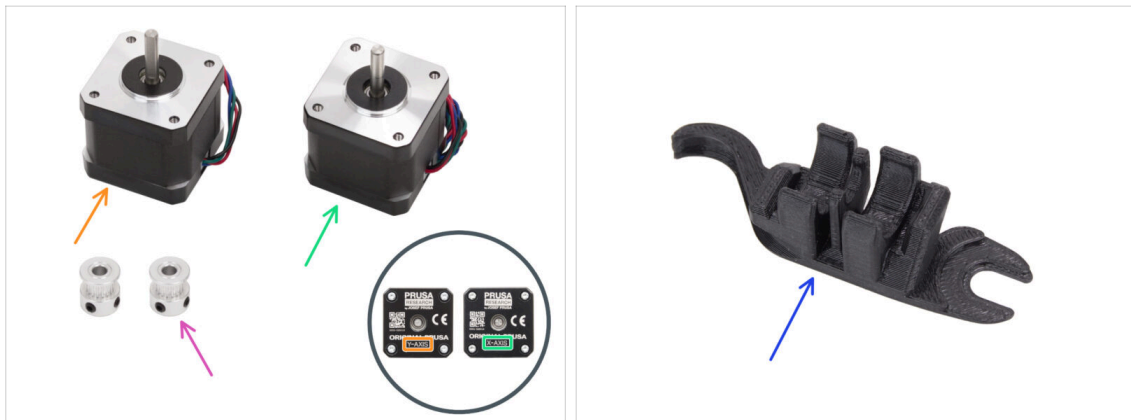
**STEP 41** X&Y motors: parts preparation

- ◆ **For the following steps, please prepare:**
- ◆ Y-axis motor (1x)
- ◆ X-axis motor (1x)
- ⓘ Note that the motors are marked as X and Y-axes in order to distinguish between them. We will continue to follow this marking.
- ◆ Pulley T16-2GT (2x)
- ◆ Assembly-multi-tool (1x) *you already used*

## STEP 42 Installing the X-axis pulley



- Prepare the **X-axis** motor.
- Note the flat part on the motor shaft.
- ⚠ Slide the Pulley on, **note the CORRECT orientation**.
  - Rotate the motor shaft with the flat part facing you.
  - Using the fork on the Assembly-multi-tool set a gap between the pulley and the motor.
  - Push the pulley on the tool and firmly tighten the screw against the flat part on the shaft.
  - Rotate the pulley and firmly tighten the second grub screw.
- ⚠ Double-check the pulley orientation. **The toothed side of the pulley must be on the motor side.**

**STEP 43** Installing the Y-axis pulley

- Prepare the **Y-axis** motor.
- Note the flat part on the motor shaft. Rotate the motor shaft with the flat part facing you.
- ⚠ Slide the Pulley on, and **note the CORRECT orientation. The Y-axis pulley orientation is DIFFERENT from the X-axis. Make sure the pulley teeth face away from the motor. Use the wider hook on the assembly tool.**
- Using the hook on the Assembly-multi-tool, place the thicker curved part between the pulley and the motor.
- ⚠ **Do not try to hook it around the shaft.** Just rest the tool against the motor and make sure the hook tip slides between the motor and the pulley.
- Push the pulley on the tool and firmly tighten the screw against the flat part on the shaft.
- Rotate the pulley and firmly tighten the second grub screw.
- ⚠ **Double-check the pulley orientation. The teeth must face away from the motor.**

## STEP 44 XY belts: parts preparation

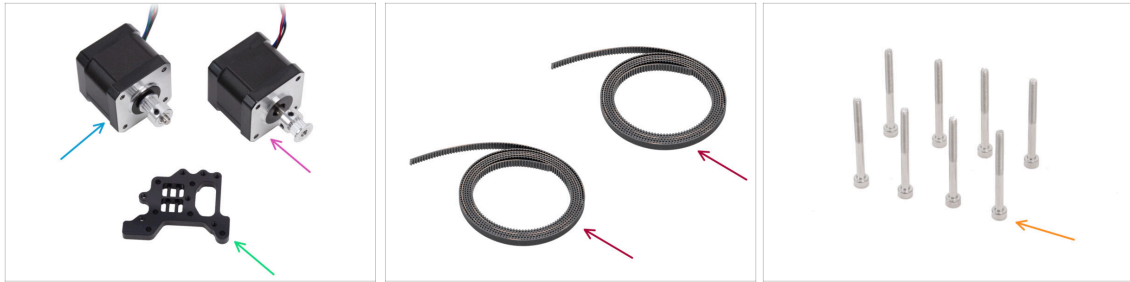

### For the following steps, please prepare:

- X-axis motor assembly (1x) you assembled earlier
- Y-axis motor assembly (1x) you assembled earlier
- XY belt (2x) found in the CORE XY parts + hinges + HB set package
- Nextrunder holder (1x) found in the CORE XY parts + hinges + HB set package
- M3x35 screw (8x)

## STEP 45 XY belts INFO



**i** The next steps cover belt installation and guiding on the core XY assembly. Before starting, refer to the illustration for an overview and better understanding of each belt's path.

- X-axis belt - at the **top position**
  - Y-axis belt - at the **bottom position**
- Let's guide the belts step by step...

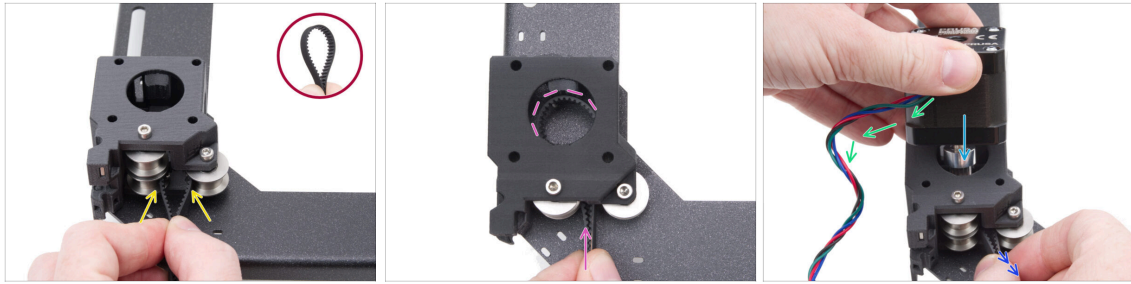
**STEP 46** Y belt guiding: Y motor pulley

- From the back of the CoreXY, focus on the motor-mount on the **left** side.
- Create a loop anywhere on the belt so the **belt teeth are pointing inside** the loop.
- Push this loop through the space between the lower pulleys inside the motor mount.
- Push through enough to make the loop follow the top round hole of the motor-mount as closely as possible.
- Insert the **Y** motor into the motor holder, the pulley must be in the middle of the belt loop.
- Insert the Y motor pulley into the motor mount, ensuring the pulley is centered within the belt loop.  
Fully attach the motor to the motor-mount with the motor cable facing you.
- Pull lightly on the belt loop to encircle the pulley.

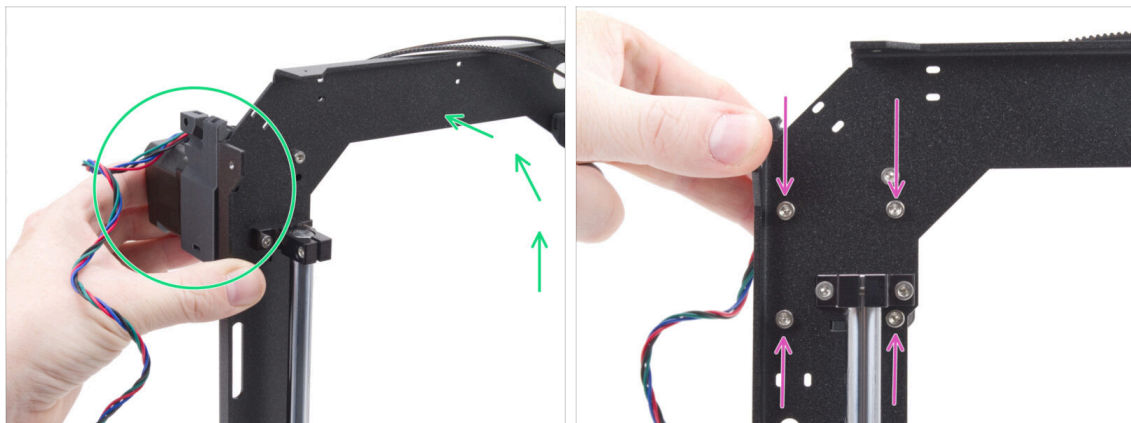
**STEP 47** Securing the Y-axis motor

- Firmly grasp the Y-axis motor assembly and position the CoreXY assembly vertically. **Do not drop the motor!**
- ⚠ **Be careful not to pull the entire belt out of the motor.**
- Keep holding the motor with one hand. With the other hand, secure the motor using four M3x35 screws on the underside of the frame. **Tighten firmly.**
- Place the CoreXY assembly back into the horizontal position.

## STEP 48 Y belt guiding: Y motor mount



- ◆ Guide the left end of the belt around the lower left pulley.
- ◆ Push the belt through the part and guide it to the front of the CoreXY plate.
- ⚠ **Don't pull too long so you don't pull the whole belt out.** Remember that the other end is loose. The whole process would then have to be repeated.

## STEP 49 Y belt guiding: belt tensioner



- ◆ Guide the belt around the pulley in the belt tensioner.
- ◆ Push the belt around the front pulley in the linear assembly.
- ◆ Prepare the Nextruder holder in the same orientation as in the picture. Note the holes for securing the belts.
- ◆ Push the end of the belt through the middle hole into the left hole in the bottom row - leave 4-5 teeth sticking out.
- ⓘ The belt is secured on this end. You can leave it free for now.

## STEP 50 Y belt guiding: X motor mount

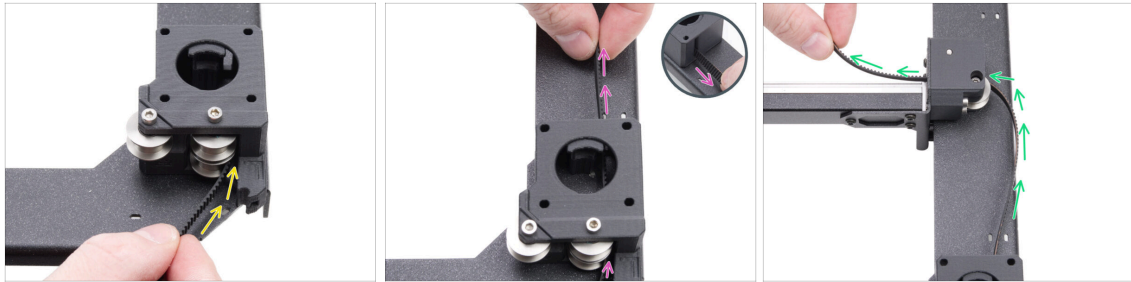

- ◆ Back to the other end of the Y belt.
- ◆ Take the other end of the belt and guide it around the lower pulley in the X motor mount.
- ◆ Push it through the motor mount to the front.
- ◆ Route the belt around the lower right pulley in the linear rail holder.

## STEP 51 Y belt guiding: securing the belt

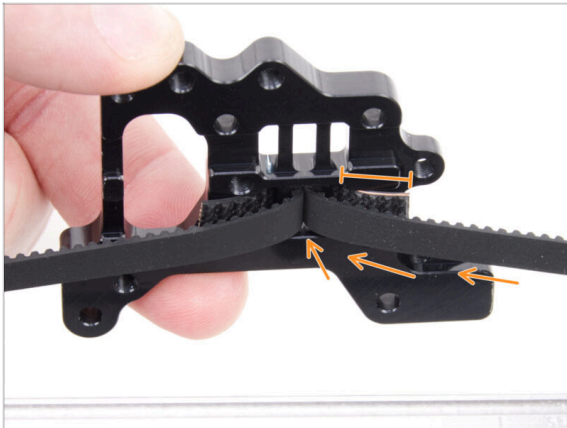

- ◆ Push the end of the belt through the middle hole to the right hole in the bottom row of the Nextruder holder - leave 4-5 teeth sticking out.
- ⓘ If it's difficult to reach the Nextruder holder with the belt, you can loosen the belt tensioner screw on the front of the assembly.
- 📌 Don't forget to adjust it back after securing the belt.

## STEP 52 X belt guiding: X motor pulley

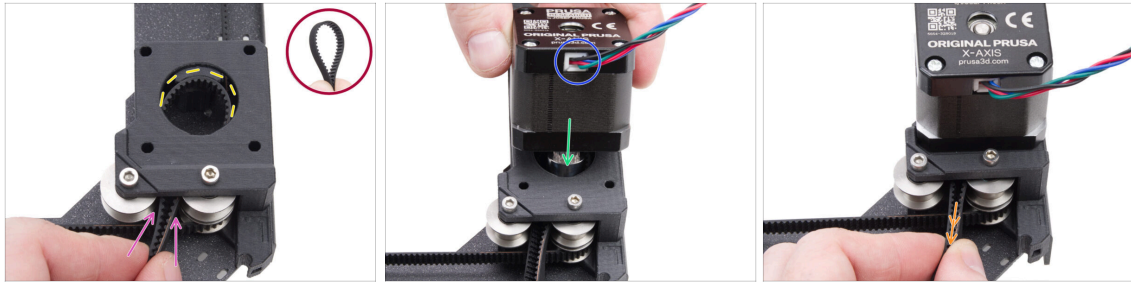

- From the back of the CoreXY, focus on the motor-mount on the **right** side.
- Create a loop anywhere on the second belt so the belt teeth are pointing inside the loop.
- Push this loop through the space between the upper pulleys inside the motor mount.
- Push through enough to make the loop follow the top round hole of the motor-mount as closely as possible.
- Insert the **X** motor pulley into the motor mount, ensuring the pulley is centered within the belt loop.
- Ensure the motor cable is facing you (rear).
- Pull lightly on the belt loop to encircle the pulley.

## STEP 53 Securing the X-axis motor

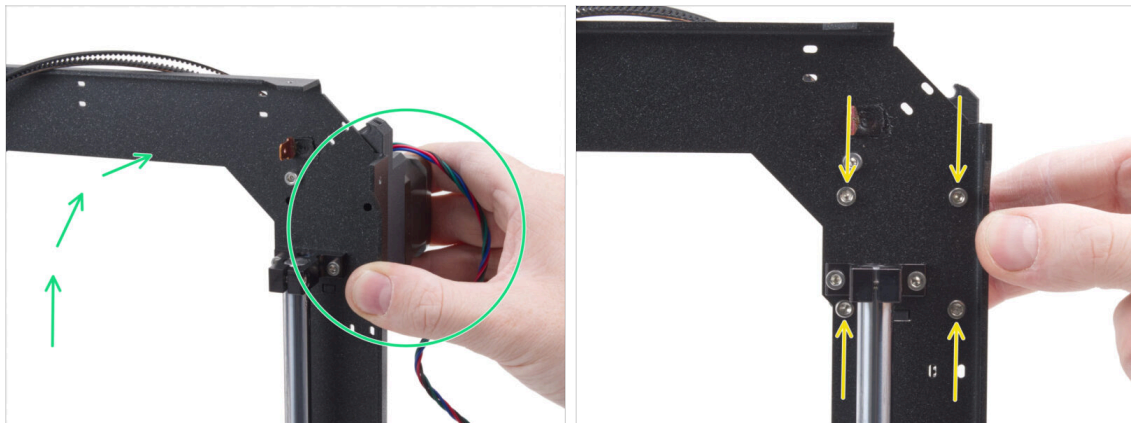

- Firmly grasp the X-axis motor assembly and position the CoreXY assembly vertically. **Do not drop the motor!**
- ⚠ **Be careful not to pull the entire belt out of the motor.**
- Keep holding the motor with one hand. With the other hand, secure the motor using four M3x35 screws on the underside of the frame. **Tighten firmly.**
- Place the CoreXY assembly back into the horizontal position.

## STEP 54 Y belt guiding: X motor mount



- Guide the right end of the belt around the upper right pulley.
- Push the belt through the part and guide it to the front of the CoreXY plate.
- ⚠ **Don't pull too long so you don't pull the whole belt out.** Remember that the other end is loose. The whole process would then have to be repeated.

## STEP 55 X belt guiding: belt tensioner



- Guide the belt around the pulley in the belt tensioner.
- Push the belt around the front upper pulley in the linear assembly.
- Route the end of the belt through the middle hole into the right hole - leave 4-5 teeth sticking out.
- ⓘ The belt is secured on this end. You can leave it free for now.

## STEP 56 X belt guiding: Y motor mount

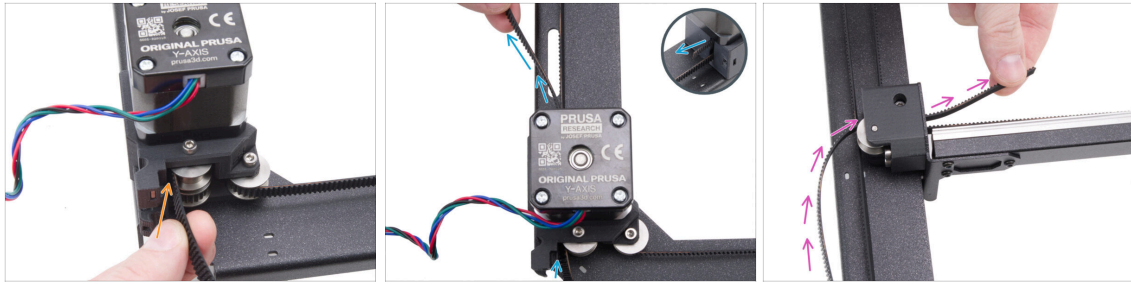

- Take the other end of the belt and guide it around the upper pulley in the Y motor mount.
- Push the belt through the motor mount.
- Route the belt around the upper front pulley in the linear rail holder.

## STEP 57 X belt guiding: securing the belt



- Push the end of the belt through the middle hole to the left hole in the upper row of the Nextruder holder - leave 4-5 teeth sticking out.

## STEP 58 Checking the belt guidance



Before proceeding, recheck the belt routing according to the illustration.

## STEP 59 Bowden guide: parts preparation

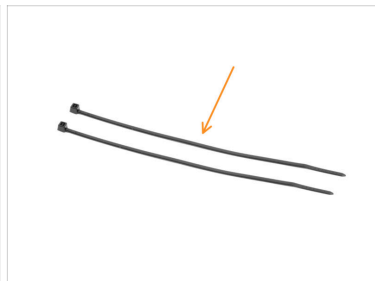
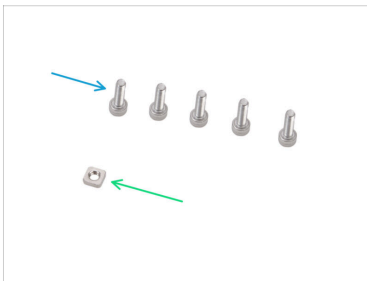

- **For the following steps, please prepare:**
- Bowden-guide (1x) *found in the Printed parts package*
- M3x10 screw (5x)
- M3nS nut (1x)
- Zip tie (2x)

## STEP 60 Securing the Nextruder holder

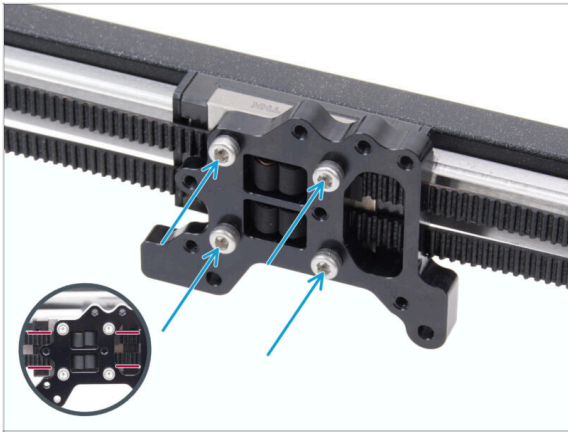

- Attach the Nextruder holder to the linear rail carriage and secure it using four M3x10 screws.

**⚠ CAUTION: Ensure no belt obstructs the screw. Avoid screwing through the belt!**

## STEP 61 Securing the Y motor cable

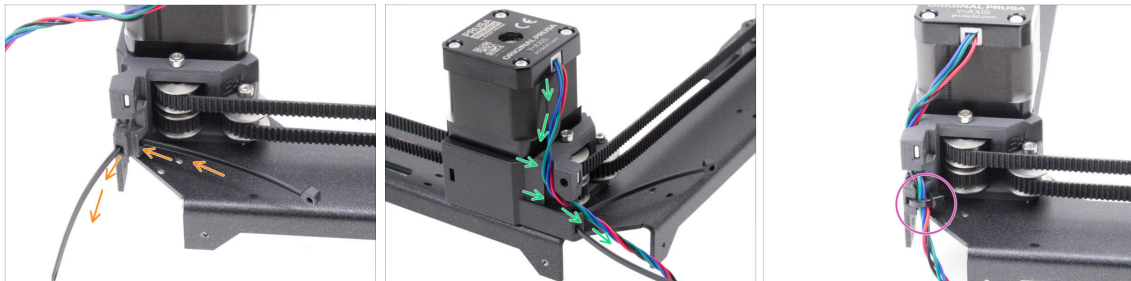

- Push the zip tie through the motor-mount-right (Y-axis motor).
- Route the Y motor cable through the cable channel in the motor-mount-right and over the zip tie.
- Secure the cable with a zip tie and trim the excess.

## STEP 62 Securing the X motor cable

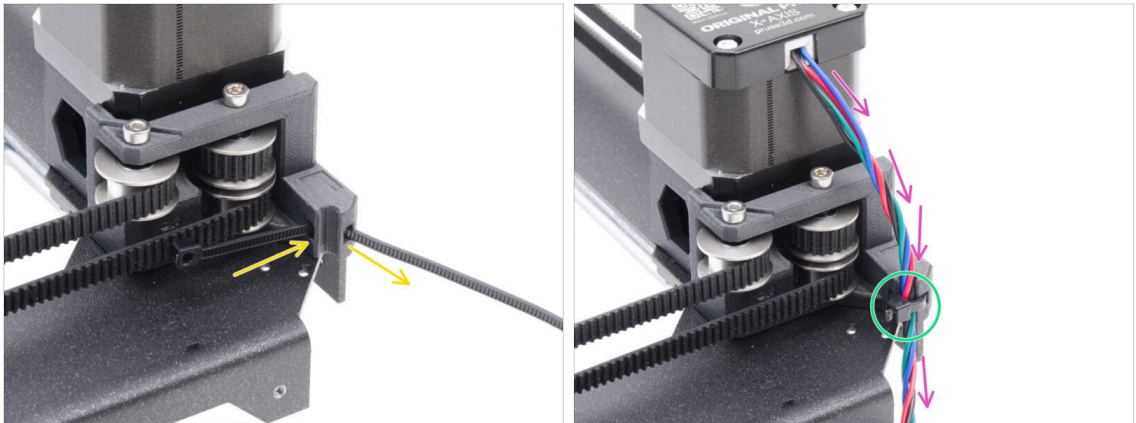

- Push the zip tie through the motor-mount-left (X-axis motor).
- Route the X motor cable through the cable guide in the motor-mount-right and over the zip tie.
- Secure the cable with a zip tie and trim the excess.

## STEP 63 Installing the bowden guide

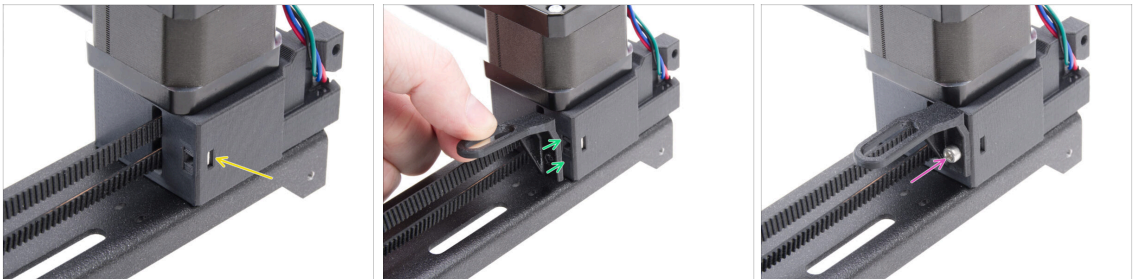

- Insert the M3nS nut into the motor-mount-right (Y-axis motor).
- Attach the bowden-guide to the motor-mount-right.  
⚠ Note the correct orientation of the part.
- Fix the bowden-guide in place using the M3x10 screw.

## STEP 64 White LED strip: parts preparation



For the following steps, please prepare:

White LED strip (1x) found in the Electronics & Fasteners package

CoreXY strut (1x) found in the Metal parts 1/3 package

**i** The part is inserted in a foam cutout and may not be immediately visible at first glance.

M3x4rT screw (2x)

## STEP 65 Sticking the White LED strip



Carefully peel off the protective (paper) layer from the White LED strip.

**⚠** After removing the protective layer, the LED strip is adhesive.

Position the White LED strip near the CoreXY strut to check alignment, but **do not attach it yet**.

**⚠** Note the rectangular cutout on the strut, orient the strip cable to the same side.

Stick the White LED strip evenly to the strut - on the side with the rectangular cutout.

After sticking, press lightly on the blank areas of the strip to ensure adhesion. **Do not touch LEDs and resistors!**

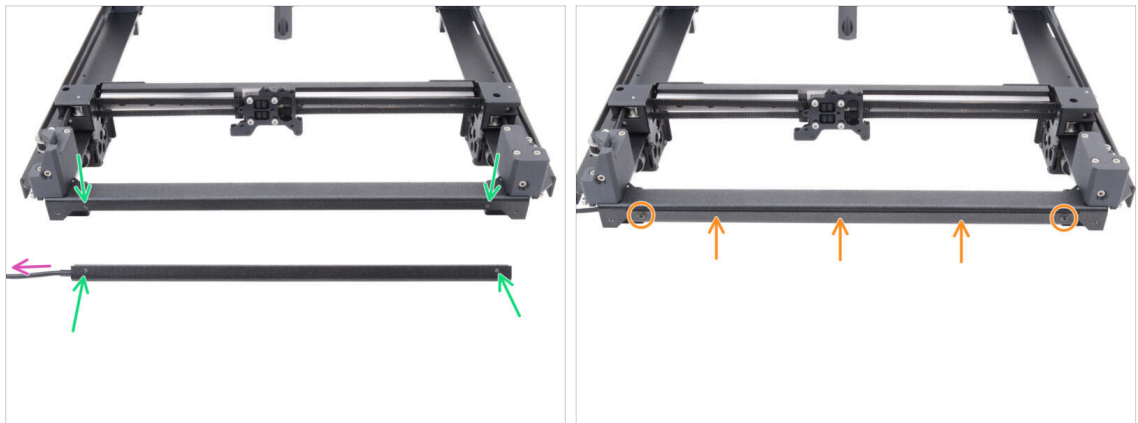
**STEP 66** Installing the white LED assembly

- Take the white LED assembly and attach it to the front of the CoreXY assembly. Align the holes of both parts.
- **The white LED strip cable must point to the left.**
- Attach the LED assembly to the CoreXY plate and secure it with two M3x4rT screws.

**STEP 67** Door sensor & White LED strip: parts preparation

- **For the following steps, please prepare:**
- Door sensor (1x) *found in the Electronics & Fasteners package*
- M2.5x10 screw (1x) *silver*
- Zip tie (4x)

## STEP 68 Inserting the zip ties

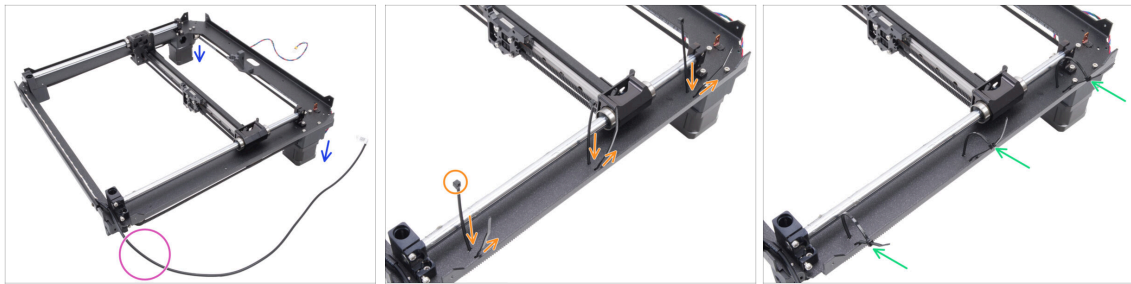

- ◆ Flip the CoreXY assembly upside down and rest it on the motors.
- ◆ Position it with the white LED strip cable facing toward you.
- ◆ Thread three zip ties through the CoreXY plate, ensuring the zip tie heads point inward.
- ◆ Partially tighten the zip ties—just enough to catch the first few teeth.
- ⚠ **Do not fully secure them yet, as we will route cables through them later.**
- ◆ Flip the assembly back with the motors facing upwards.

## STEP 69 Installing the door sensor



- ◆ Place the door sensor on the left belt tensioner. The lever of the door sensor must face forward.
- ◆ Secure the door sensor with the M2.5x10 screw.
  - ◆ Tighten the bolt fully and then loosen 1/4 turn. The sensor must be allowed to move.
- ◆ From the rear of the belt tensioner, tighten the M3x12 screw so that it touches the door sensor.

## STEP 70 Securing the door sensor cable

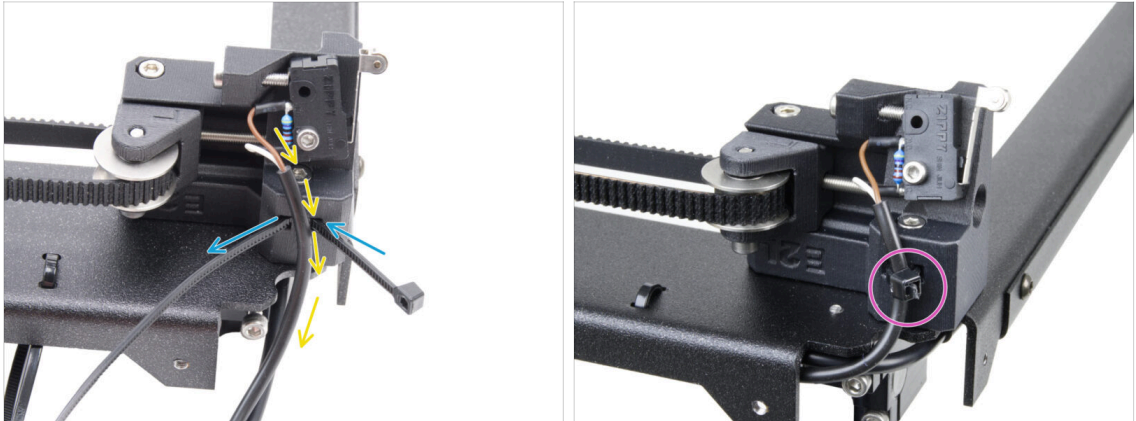

- ◆ Push the zip tie through the hole in the left belt tensioner.
- ◆ Guide the door sensor cable through the zip tie.
- ◆ Tighten the zip tie to secure the door sensor cable. Cut off the excess.

## STEP 71 Guiding the cables: LED and door sensor



- ◆ Prepare a cardboard box. You can use any box from the kit. *The box used in the picture is for illustrative purposes only.*
- ◆ Flip the CoreXY assembly upside down, positioning the smooth rods on top.
- ◆ Slightly lift and support the front side of the CoreXY assembly with the cardboard box.
- ⚠ **Be careful not to damage the door sensor.**
- ◆ Route the white LED strip cable and the door sensor cable through the zip ties.
- ◆ Tighten all the zip ties to secure the cables. Cut off the excess zip ties.
- ◆ **Cables must be slightly taut and straight.** Excess slack or bends may cause collisions with the Y-axis and lead to damage.

## STEP 72 Smooth rods: parts preparation



- For the following steps, please prepare:
- Smooth rod 330 x 8 mm (2x) *originally from the Y-axis.*
- M3x8rT screw (1x)

## STEP 73 Installing the CoreXY assembly

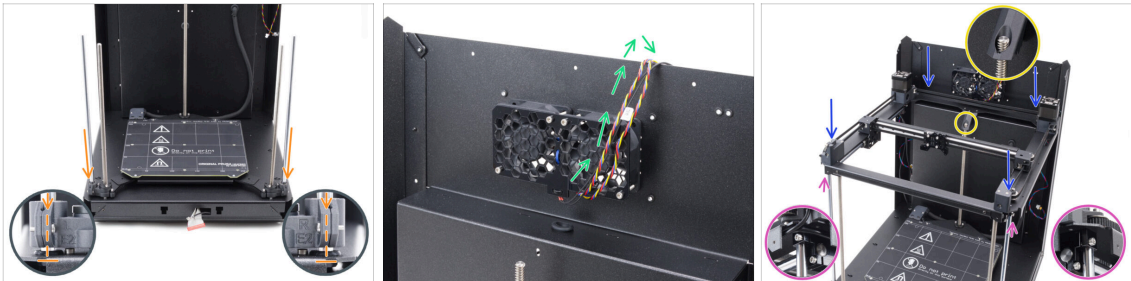

- Carefully insert both smooth rods through the heatbed assembly bearings and into the rod mount part in the base assembly.
  - ⚠ **It is a requirement to insert the smooth rod in the axis with the bearing very slowly to prevent the balls from shooting out of the bearing.**
- Temporarily hang the cables from the cooling fans over the rear panel. **There must be a space between the cables and the back panel pocket.**
- Exercise extreme caution when placing the assembly on the smooth rods and back panel assembly.
  - ⚠ **Ensure that no cables are pinched.**
    - Ensure both smooth rods are properly seated in the rod holders.
    - The threaded rod of the rear Z motor must pass through the bed-stop-rear part.
- ⚠ **WARNING: When handling the printer, DO NOT lift it by the CoreXY assembly. Always lift it by the base of the entire assembly.**

## STEP 74 Securing the smooth rods

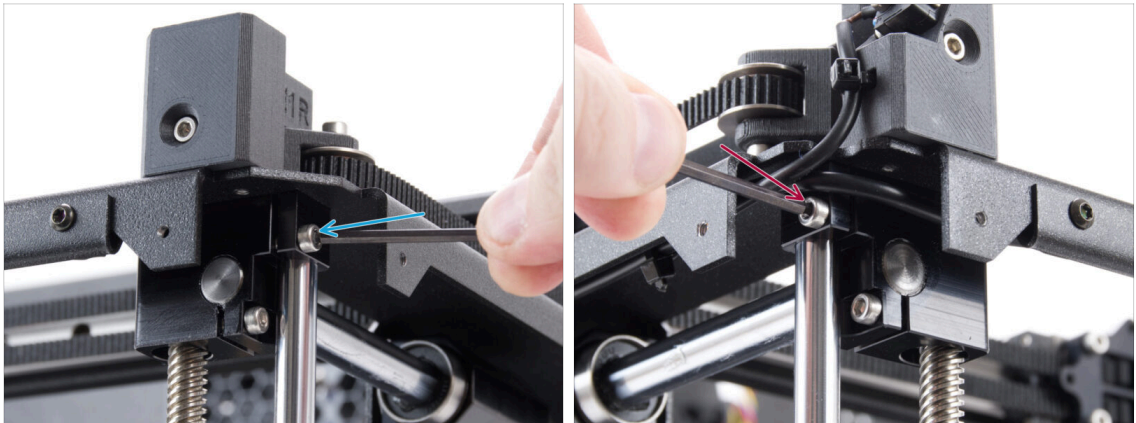

⚠ Check that both smooth rods are seated correctly in the holders.

🔵 Firmly tighten the right M3x10 screw to secure the smooth rod.

🔴 Firmly tighten the left M3x10 screw to secure the smooth rod.

## STEP 75 Aligning the linear rail

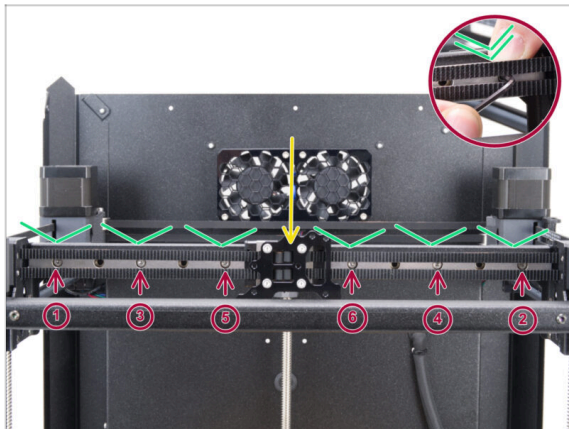

🟡 Move the linear rail carriage to the center.

⚠ Firmly tighten all screws in the order shown in the picture.

🟢 Push the linear rail down while tightening.

## STEP 76 Guiding the corexy cables

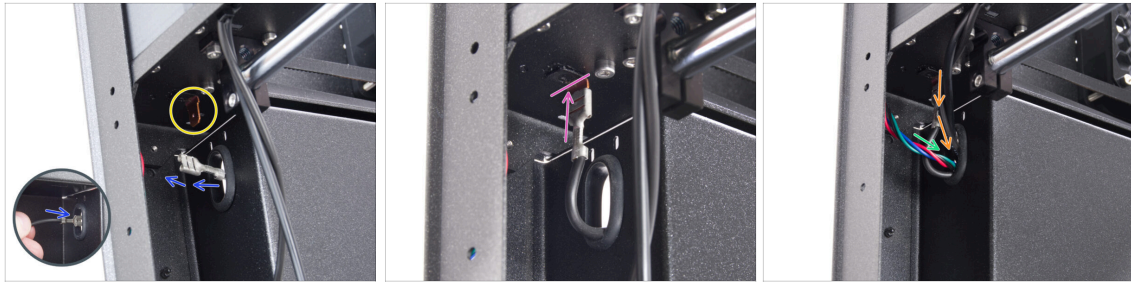

- ◆ From the back of the printer, push the FE connector through the oval hole.
- ◆ Locate the FE cable connector (number 5) in the rear left corner - under the CoreXY assembly.
- ◆ Plug the FE connector onto the Faston on the underside of the CoreXY plate.
- ◆ On the same side, push the X motor cable through the oval hole in the back panel.
- ◆ Push the White LED strip and Door sensor cables through the oval hole in the back panel.

## STEP 77 Guiding the cooling fan cables

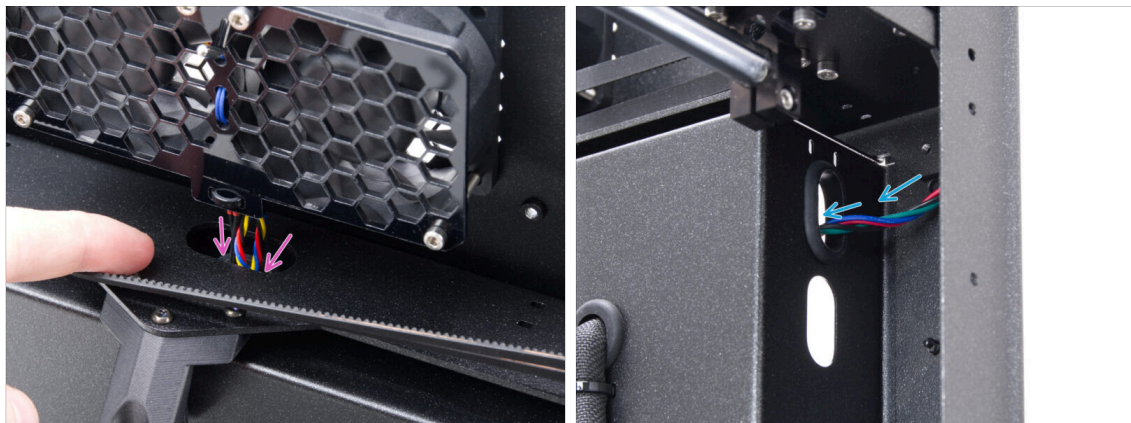

- ◆ Push the cooling fan and thermistor cables through the oval hole in the back panel.
- ◆ On the right back corner, locate the Y motor cable and push it through the upper oval hole in the back panel.

## STEP 78 Fixing the bed-stop

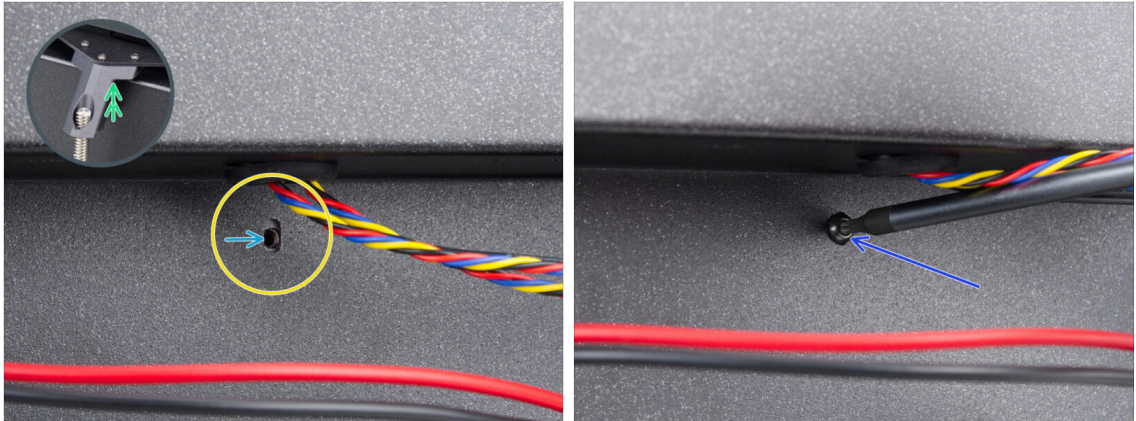

- From the back side, locate the oval screw hole under the cooling fans.
- The oval hole must be flush with the hole in the bed-stop part on the opposite side.
- To compensate, slightly raise the rear of the CoreXY assembly - just a few millimeters.
- After aligning the holes, secure them with an M3x8rT screw.

## STEP 79 Connecting the cooling fans cables

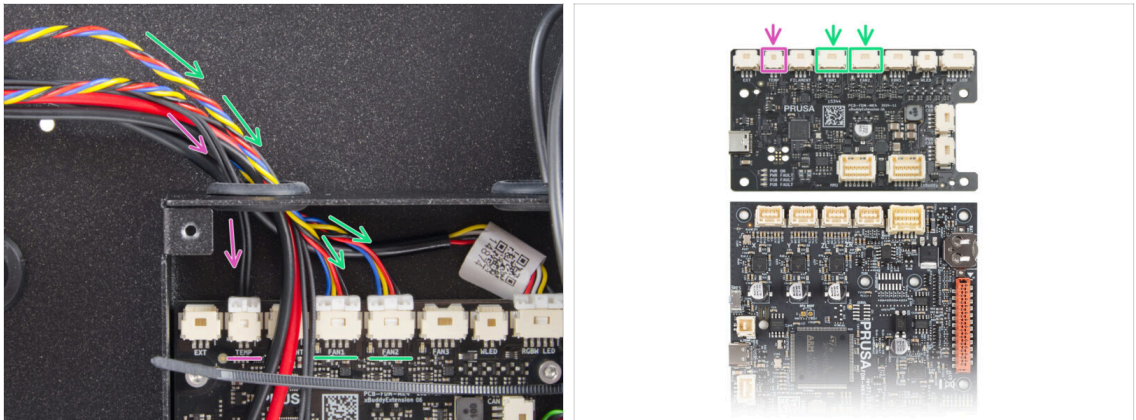

- Route the cooling fan cables through the left hole in the xBuddy box and plug them into the fourth and fifth slots on the xBuddy extension board labeled FAN 1 and FAN 2.
- ⓘ The connection order does not matter, both cables are the same.
- Guide the chamber thermistor cable together with the cooling fan cables.
- Connect it to the second slot from the left on the xBuddy extension board labeled TEMP.

## STEP 80 Connecting the corexy cables

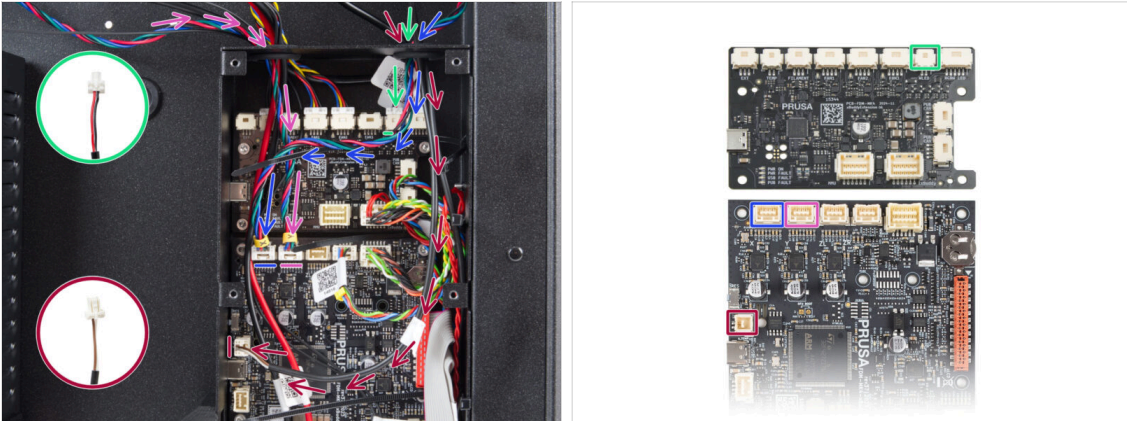

- ◆ Guide the X motor cable through the right hole in the xBuddy box. Connect it to the first slot from the left on the xBuddy board.
- ◆ Guide the door sensor cable through the right hole in the xBuddy box. Connect it to the lower slot on the left side of the xBuddy board.
- ◆ Guide the white LED strip cable through the right hole in the xBuddy box. Connect it to the second slot from the right on the xBuddy extension board.
- ◆ Guide the Y motor cable through the left hole in the xBuddy box. Connect it to the second slot from the left on the xBuddy board.

## STEP 81 Haribo time

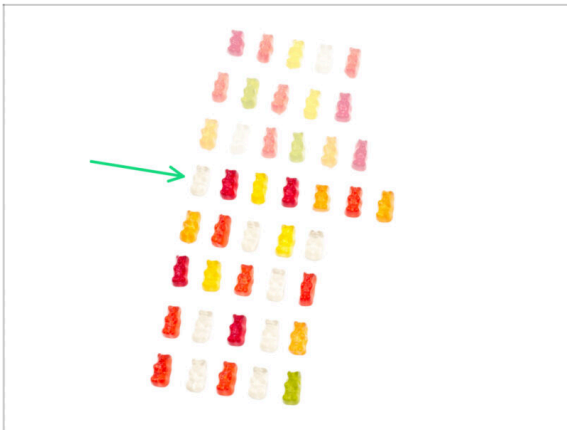

- ◆ Think it's snack o'clock again.
- ◆ You deserve to eat the whole bag, but keep... Eat just the fourth row.

**STEP 82** Done



- ◆ Congratulations! You have just assembled and installed the CoreXY assembly.
- ◆ Let's go to the next chapter.

## 6. Nextruder assembly

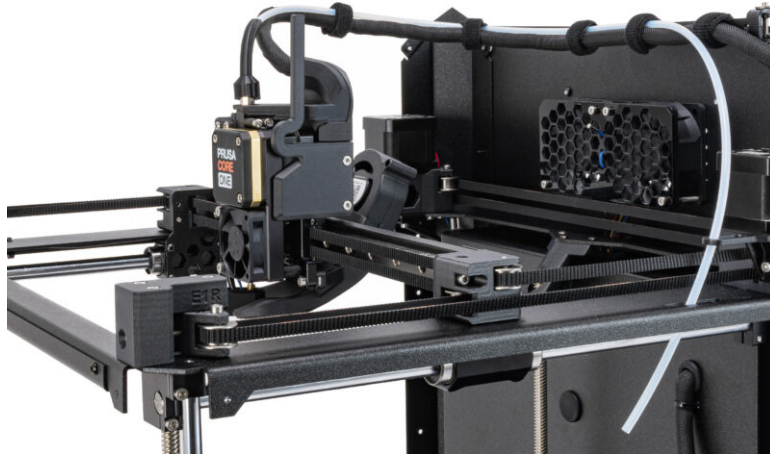

## STEP 1 Tool necessary for this chapter

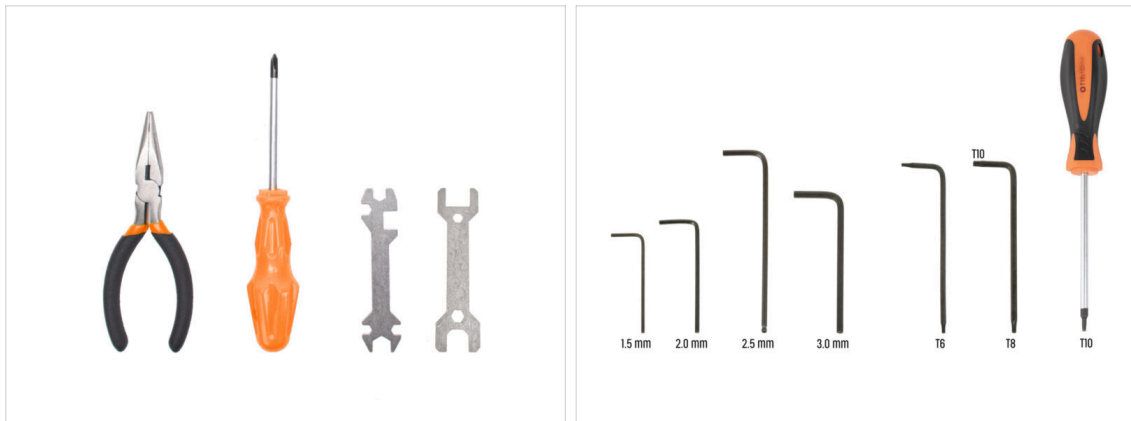

● **For this chapter, please prepare:**

- Universal wrench
- 1.5mm Allen key
- 2.5mm Allen key
- T6 torx key
- T10 torx key / T10 torx screwdriver

## STEP 2 Mounting the Nextruder: parts preparation

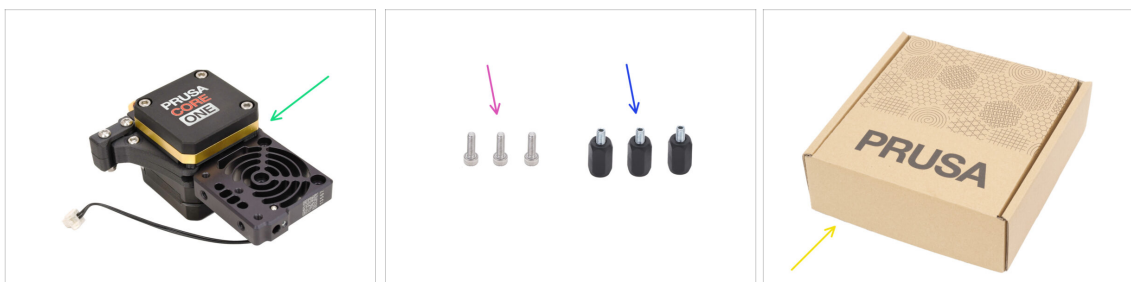

● **For the following steps, please prepare:**

- Nextruder (1x)
- Nextruder spacer (3x) *found in the Electronics & Fasteners package*
- M3x10 screw (3x)
- Cardboard box (1x) *used as temporary heatbed protection*

ⓘ Hint: You can use any cardboard box from the kit package.

### STEP 3 Protecting the heatbed



- Place an empty cardboard box on the heatbed, ensuring it covers as much of the surface as possible.
- i** This will protect the heatbed from falling parts.

### STEP 4 Mounting the Nextruder

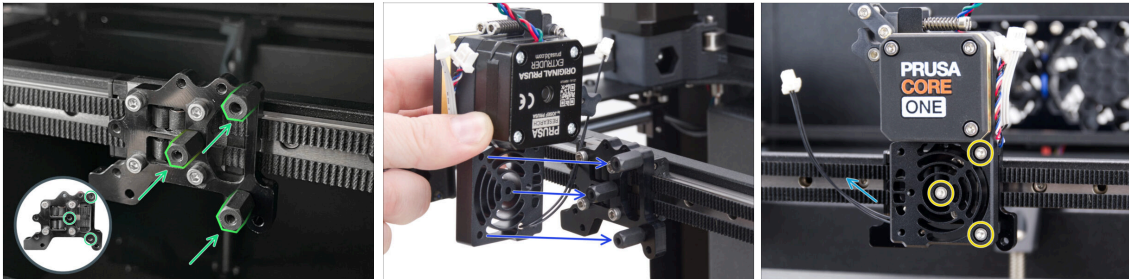

- Screw three Nextruder spacers to the Nextruder holder. Tighten the spacers firmly.
- Place the Nextruder assembly on the spacers.
- Align the holes in the Nextruder with the spacers and secure it with three M3x10 screws. **Do not overtighten the screws.**
- Ensure the NTC cable is pointing to the left.

## STEP 5 Hotend fan: parts preparation



◆ For the following steps, please prepare:

- ◆ Hotend fan (1x)
- ◆ Hotend-cable-clip (1x) *found in the Printed parts package*
- ◆ M3x4rT screw (2x)
- ◆ M3x18 screw (2x)

## STEP 6 Installing the Hotend fan

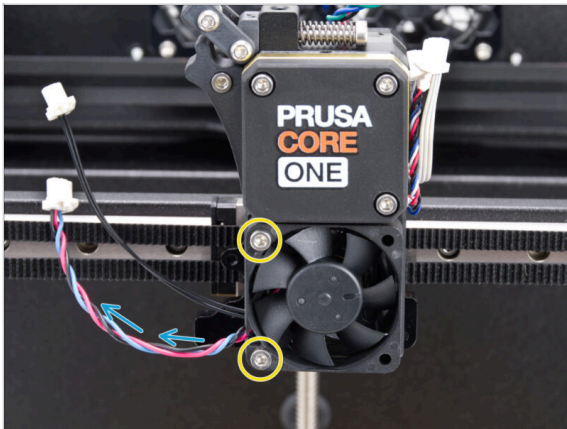

- ◆ Attach the hotend fan onto the heatsink with two M3x18 screws on the left side. **Tighten the screw gently, but firmly, otherwise the plastic housing may crack.**
- ⚠ There is a sticker on the hotend fan, the sticker must be on the rear side of the fan - not visible.
- ◆ The cable must be pointing towards the lower-left corner.

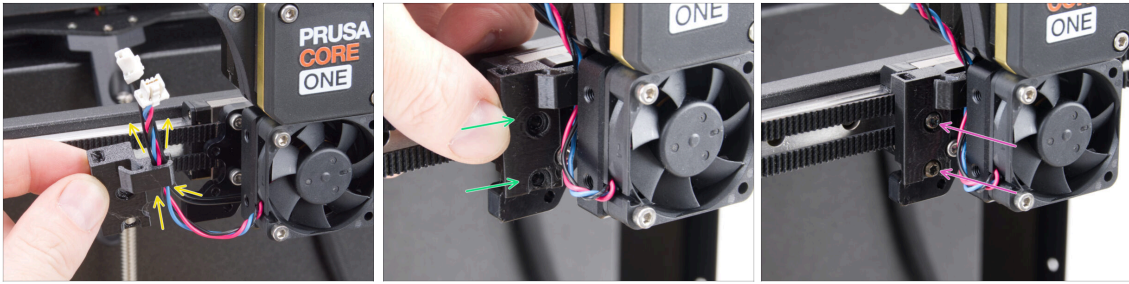
**STEP 7** Guiding the Hotend fan cables

- ✦ Take the Hotend-cable-clip in the same position as shown and guide the **heatsink fan cable** together with the **NTC thermistor cable** through the right cable hook.
- ✦ Attach the Hotend-cable-clip to the Nextruder holder.
- ✦ Secure it using two M3x4rT screws.

**STEP 8** LoveBoard: parts preparation I.

✦ **For the following steps, please prepare:**

- ✦ Printhead-cover (1x) *found in the Printed parts package*
- ✦ Loveboard-mount (1x) *found in the Printed parts package*
- ✦ Main cable (1x) *found in the Electronics & Fasteners package*

ⓘ Note: Cable color may vary depending on the batch. This does not affect the procedure.

- ✦ M3x10 screw (4x)
- ✦ M3x8rT screw (1x)
- ✦ M3nS nut (5x)

ⓘ The list continues in the next step...

## STEP 9 LoveBoard: parts preparation II.

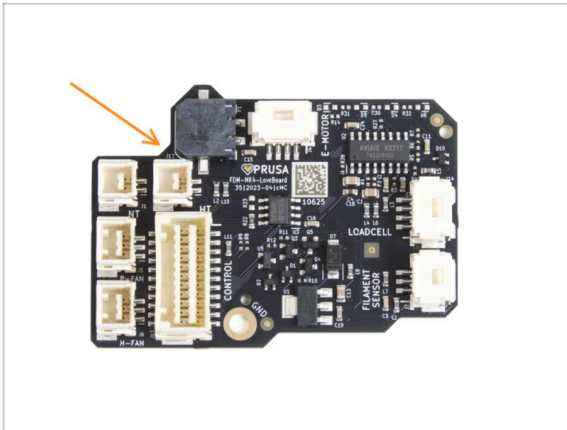

◆ For the following steps, please prepare:

- ◆ LoveBoard (1x)

## STEP 10 Assembling the Loveboard-mount

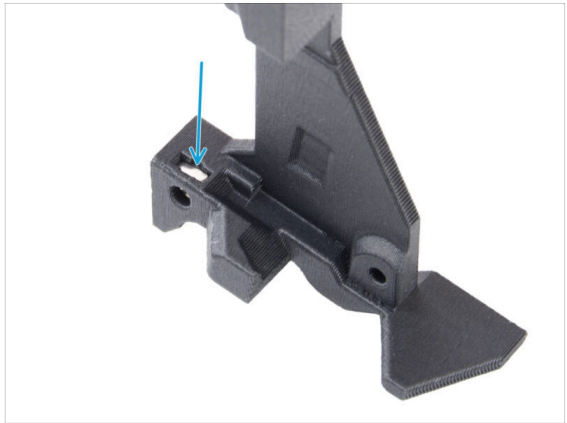

- ◆ Locate the U-shaped cable channel on the Loveboard-mount and insert an M3nS nut into the nearby hole.
- ◆ Use a 2.5mm Allen key to push the nut all the way in.
- ◆ On the opposite side of the part, insert an M3nS nut and push it into place.

## STEP 11 Assembling the Printhead-cover

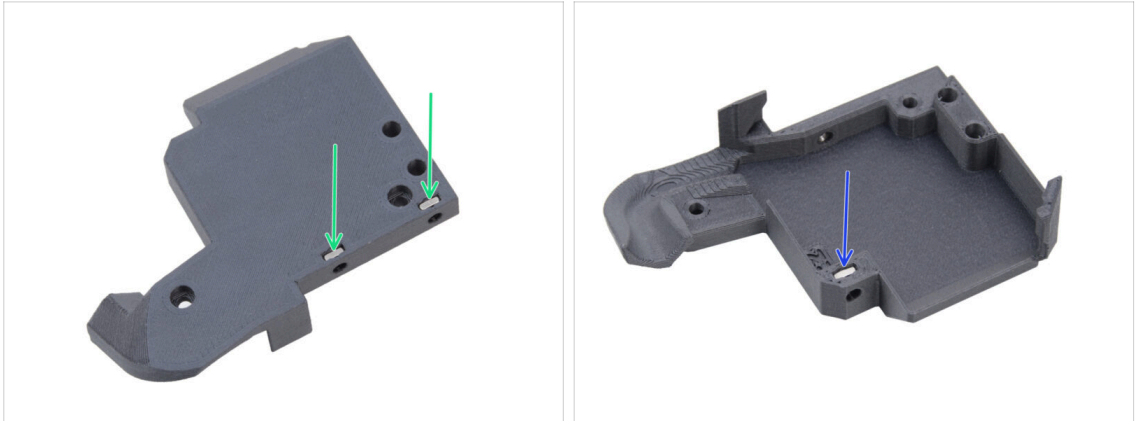

- From the back of the printhead-cover, insert two M3nS nuts into the part.
- From the other side of the printhead-cover, insert one M3nS nut into the part.

## STEP 12 Assembling the LoveBoard

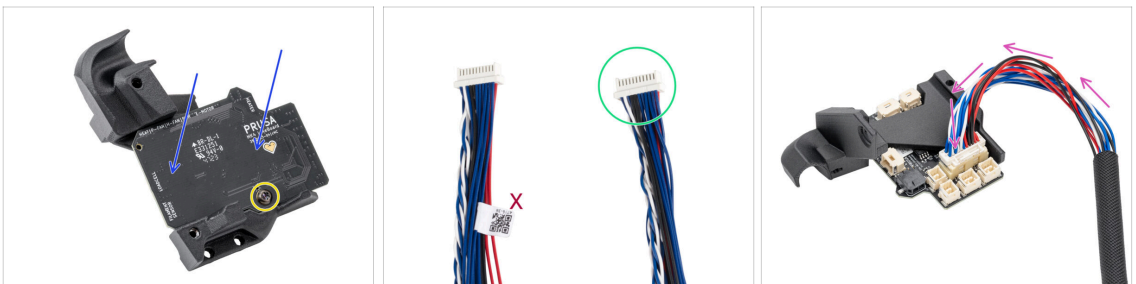

- Place the LoveBoard to the Loveboard-mount. Note the correct orientation - the connectors must be facing downwards.
- Align the holes with both parts and secure the board with the M3x8rT screw. **Do not overtighten it**, it might damage the part.
- Take the end of the extruder main cable without the white label.
- Turn the Loveboard-mount upside down and connect the Main cable to the LoveBoard.

## STEP 13 Guiding the main cable

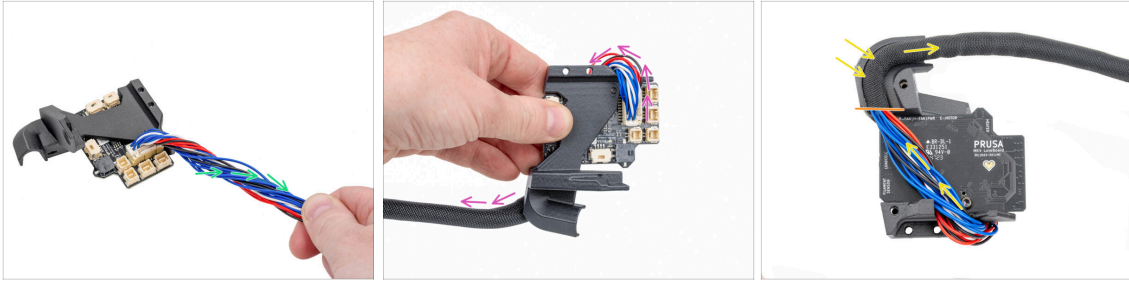

- ◆ Twist the main cable half a turn.
- ◆ Fold the main cable over the LoveBoard to its opposite side.
- ◆ Turn the LoveBoard assembly upside down.
- ◆ Guide the main cable over the LoveBoard through the cable channel in the Loveboard-mount.
- ◆ The end of the textile sleeve must align with the edge of the plastic part.

## STEP 14 Covering the LoveBoard

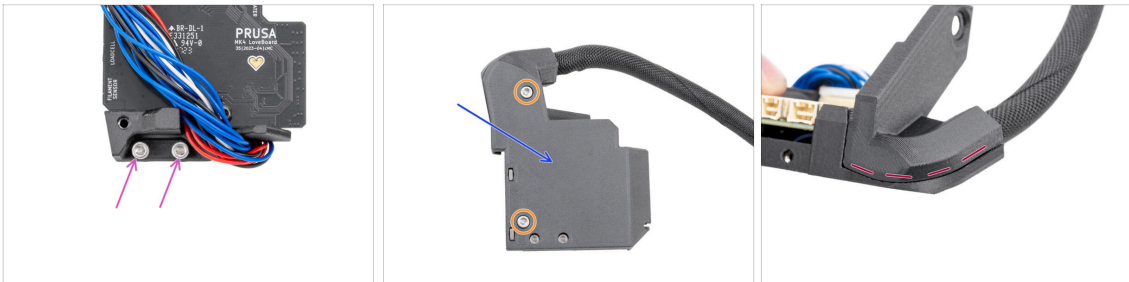

- ◆ Insert two M3x10 screws into the Loveboard-holder.
  - ⚠ Ensure you insert the screws from the correct side. Use the LoveBoard logo on the board as a reference.
- ◆ Cover the LoveBoard with the Printhead-cover.
  - ⚠ **Avoid pinching any wires in the main cable.**
- ◆ Fix both parts together using two M3x10 screws.
- ◆ Check that there is no large gap or pinched textile sleeve between the parts.

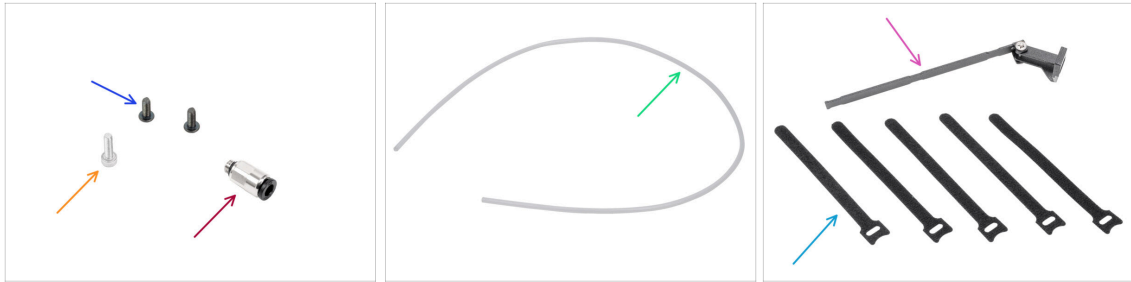
**STEP 15** Swingarm: parts preparation I.

◆ **For the following steps, please prepare:**

- ◆ M3x8rT screw (2x)
  - ◆ M3x10 screw (1x)
  - ◆ Fitting M5-4 (1x) *found in the Electronics & Fasteners package*
  - ◆ PTFE tube 710 x 4 x 2.5 (1x) *found in the CoreXY parts + Hinges set package*
  - ◆ Swingarm assembly (1x) *found in the Metal parts 3/3 package*
  - ◆ Cable tie (5x) *found in the Electronics & Fasteners package*
- ⓘ Packed in a stack and must be separated.
- ⓘ The list continues in the next step...

**STEP 16** Swingarm: parts preparation II.

◆ **For the following steps, please prepare:**

- ◆ Bowden-bend (1x) *found in the Printed parts package*
- ◆ Main-cable-clip (1x) *found in the Printed parts package*

## STEP 17 Guiding the main cable



- Carefully open the Main-cable-clip. Be careful not to crack the part.
- Insert the main cable into the Main-cable-clip.
- Place the Main-cable-clip approximately 5 - 15 cm (2 - 6 in) from the end of the textile sleeve and close the clip.
- Place the LoveBoard assembly on the cardboard box on the heatbed.
- Push the main cable behind the CoreXY assembly in the right rear corner.

## STEP 18 Mounting the main cable

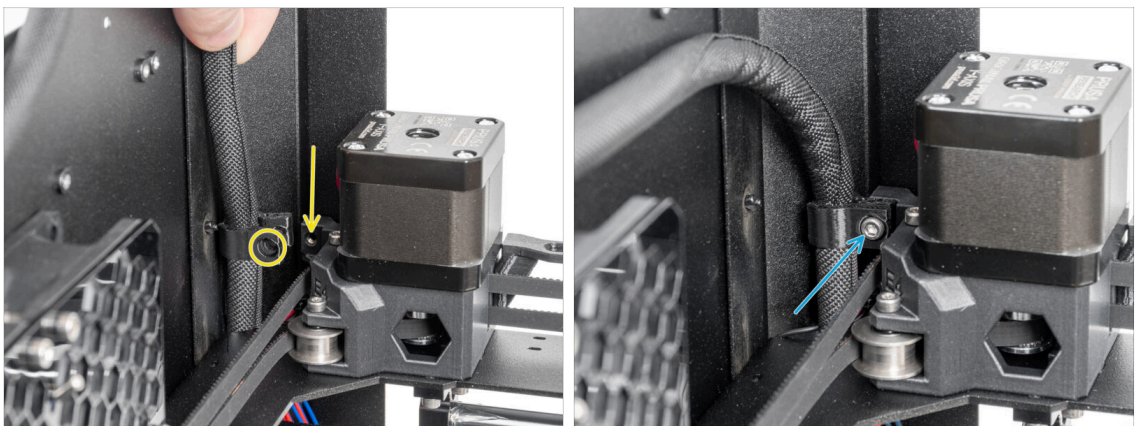

- In the right corner of the printer on the Y motor assembly, locate the hole in the plastic part and align it with the main-cable-clip.
- Fix the main-cable-clip with the cable to the hole using the M3x10 screw.

## STEP 19 Attaching the LoveBoard assembly

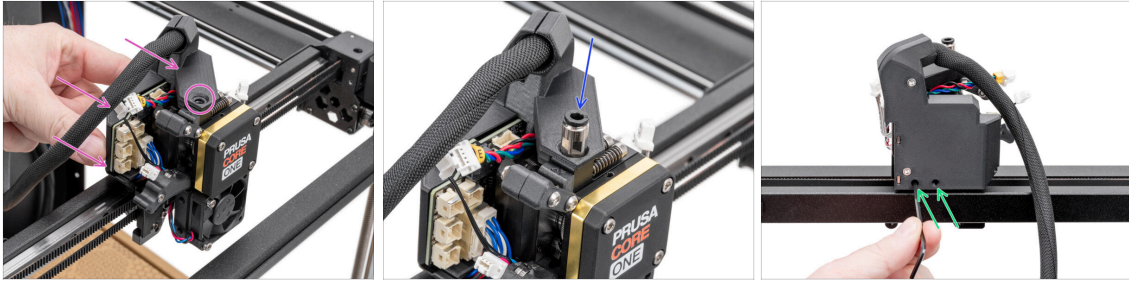

- ◆ From the back of the Nextruder, attach the LoveBoard assembly to the Nextruder.
- ◆ Align the hole in the Loveboard-mount with the threaded hole in the top of the heatsink (Nextruder).
- ◆ Insert and tighten the fitting M5-4 to the heatsink. Use the universal wrench.
- ◆ From the back of the Nextruder, tighten the two M3x10 screws to secure the LoveBoard assembly.

## STEP 20 Mounting the swingarm

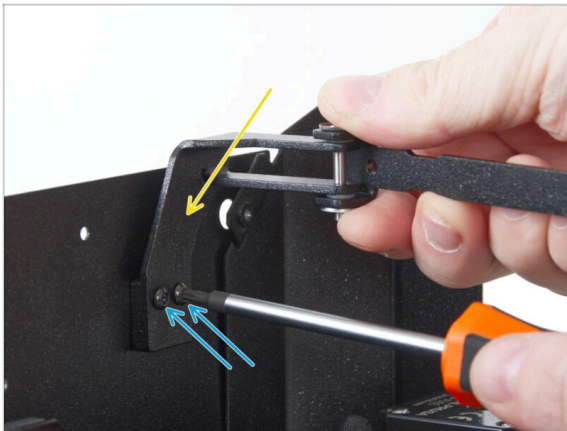

- ◆ Attach the swingarm assembly to the pair of threaded holes on the back panel near the top right corner.
- ◆ Secure it with two M3x8rT screws.
- ⚠ Do not overtighten the screws, as this may strip the threads.

**STEP 21** Attaching the main cable

- Notice the cutouts on the swingarm.
- Position the main cable at the first cutout on the swingarm.
- Place one cable tie behind the first cutout on the swingarm, ensuring the correct orientation of the zip strip.
- Thread the cable tie through its eyelet, wrapping it around the swingarm and main cable.
- Tighten the cable tie as much as possible.
- Wrap the cable tie around.

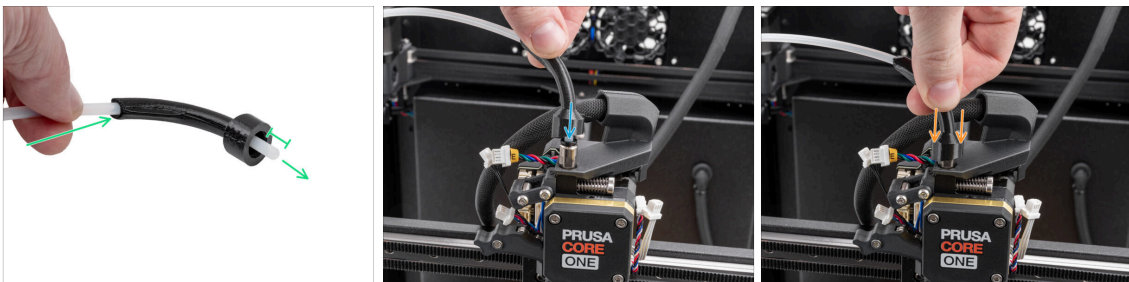
**STEP 22** Inserting the PTFE tube

- Push one end of the PTFE tube through the bowden-bend and keep protruding at least 1 cm (0.39 in) of the tube.
- Insert the PTFE tube into the fitting M5-4 on the Nextruder. Push it all the way down.
- Slide bowden-bend down to cover the fitting M5-4.

## STEP 23 Securing the PTFE tube

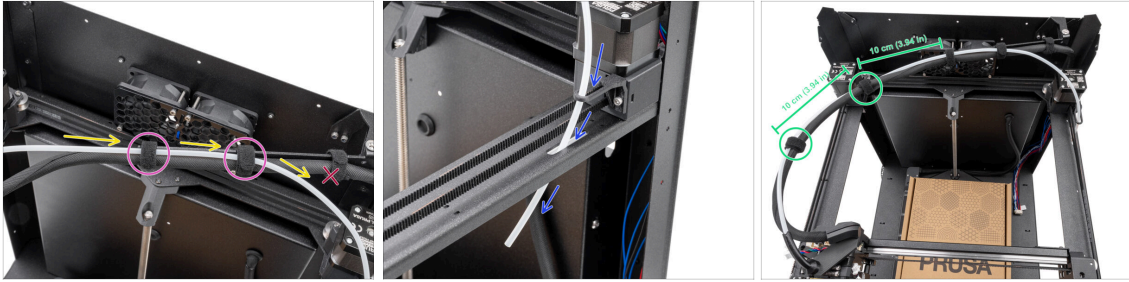

- ◆ Route the PTFE tube in parallel with the main cable, ensuring the PTFE tube stays above the main cable.
- ◆ Secure the PTFE tube and main-cable to the swingarm using two cable ties to the remaining cutouts.
- ⚠ Do not pass the PTFE tube through the first cable tie on the swingarm.
- ◆ Push the free end of the PTFE tube through the Bowden guide and CoreXY plate downward. Leave the end hanging freely.
- ◆ Merge the PTFE tube and main-cable with the remaining two cable ties, leaving a 10 cm (3.94 in) distance between them.

## STEP 24 Checking the movement

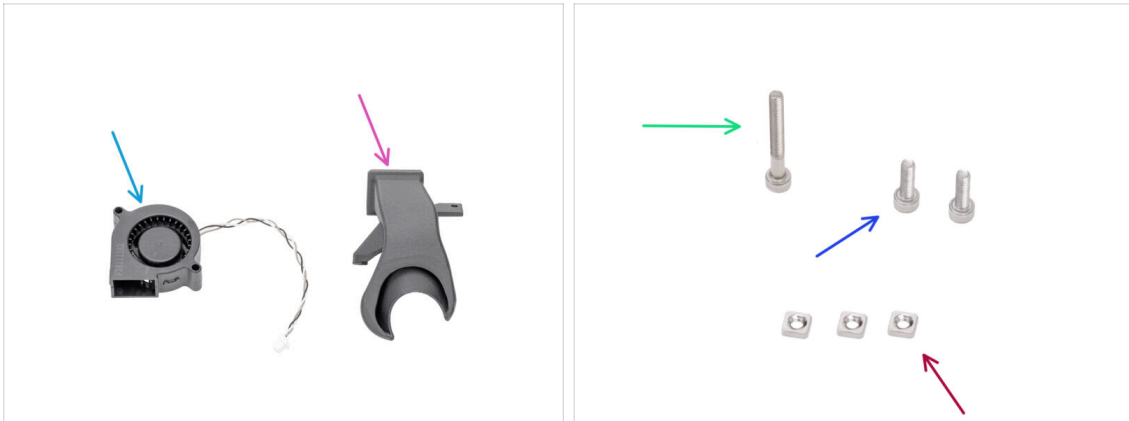

- ◆ Manually move the XY axes to their end positions several times and ensure that:
  - ◆ The main cable is not too tight and does not pull the Nextruder backward.
  - ◆ The main cable does not form an excessively large arc.
    - ◆ If the cable is too tight or forms a large arc, slightly loosen the screw on the main cable clip and pull the cable upward or downward by a few millimeters. Then, tighten the screw and test again.

**STEP 25** Print fan: parts preparation

◆ **For the following steps, please prepare:**

- ◆ Print fan (1x) *taken from the previous printer*
- ◆ Fan-shroud (1x) *found in the Printed parts package*
- ◆ M3x25 screw (1x)
- ◆ M3x10 screw (2x)
- ◆ M3nS nut (3x)

**STEP 26** Assembling the fan-shroud

- ◆ Insert two M3nS nuts from one side into the fan-shroud.
- ◆ From the other side, insert one M3nS nut into the fan-shroud.
- ◆ Insert the print fan into the fan-shroud as shown. See the correct orientation of the parts.
- ◆ Secure both parts together with one M3x25 screw.

⚠ **Do not overtighten the screws to avoid damaging the fan housing.**

## STEP 27 Installing the print fan assembly

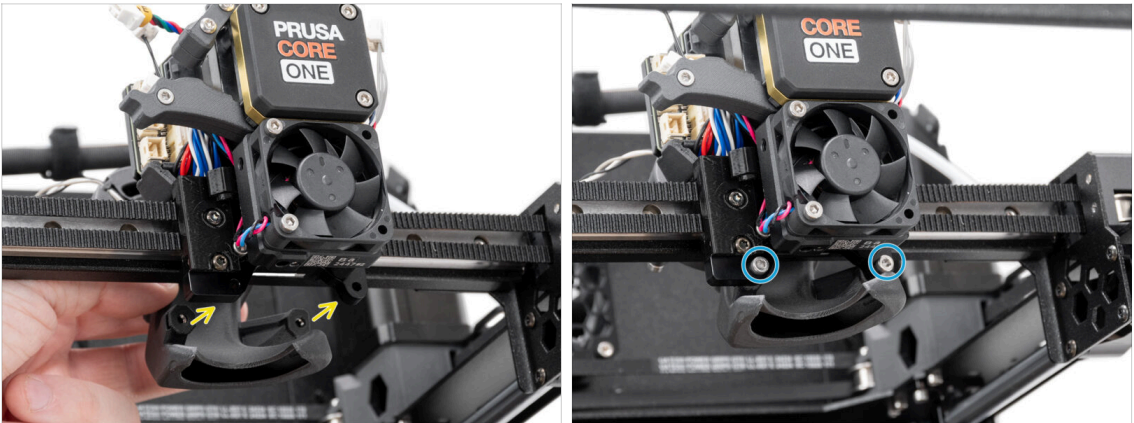

- Attach the print fan assembly to the back of the Nextruder.
  - Align the holes in the Nextruder bracket with the holes in the fan-shroud.
  - Secure the fan-shroud to the Nextruder holder using two M3x10 screws.

## STEP 28 Hotend: parts preparation

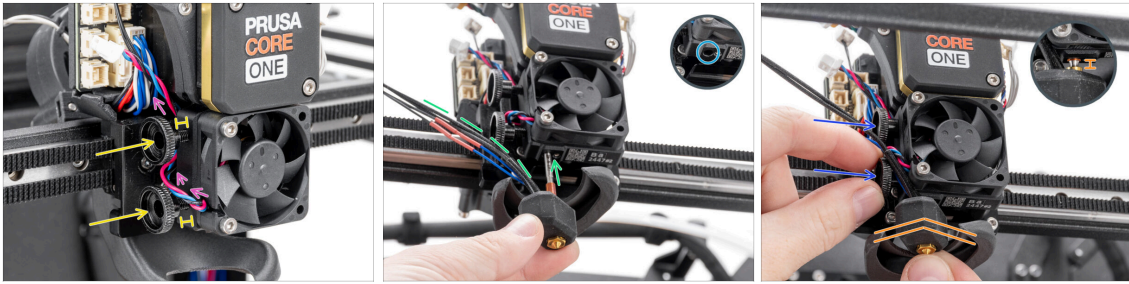

- **For the following steps, please prepare:**
  - Thumb screw (2x) you removed earlier
  - Prusa Hotend assembly (1x) you removed earlier

**STEP 29** Installing the hotend

- ✿ Route the heatsink fan cable above the first threaded hole in the heatsink.
  - ✿ Insert two thumb screws into the heatsink. **Do not tighten them completely.** Two turns are enough for now.
  - ✿ Look closely at the underside of the heatsink and find the hole for the hotend assembly.
  - ✿ Insert the hotend assembly tube in the hole and slide the whole thing into the heatsink.
    - Point the cables to the left according to the photo.
  - ✿ Push the hotend assembly all the way into the heatsink. There should be approximately a 2 mm (0.08 in) gap between the heatsink and the brass part of the nozzle.
  - ✿ While pushing the hotend assembly in, **firmly tighten both thumb screws.**
- ⚠ **Avoid pinching any cable between the screws and the heatsink!**

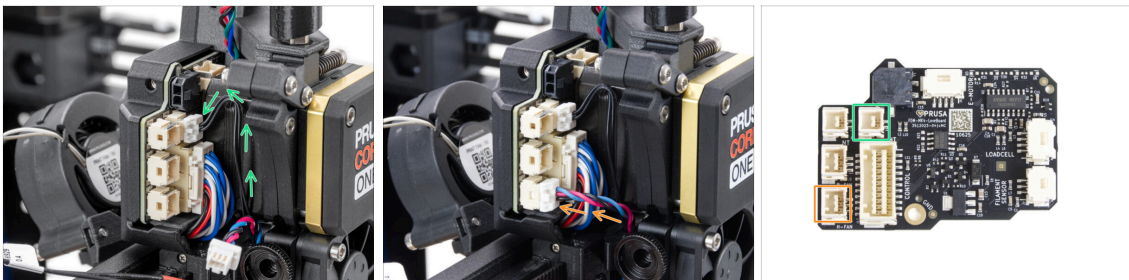
**STEP 30** Connecting the heatsink cables

- ✿ Plug the NTC thermistor cable into the connector above the main cable on the LoveBoard.
- ✿ Plug the Hotend fan cable into the lower connector in the left row of the LoveBoard.

### STEP 31 Connecting the hotend cables

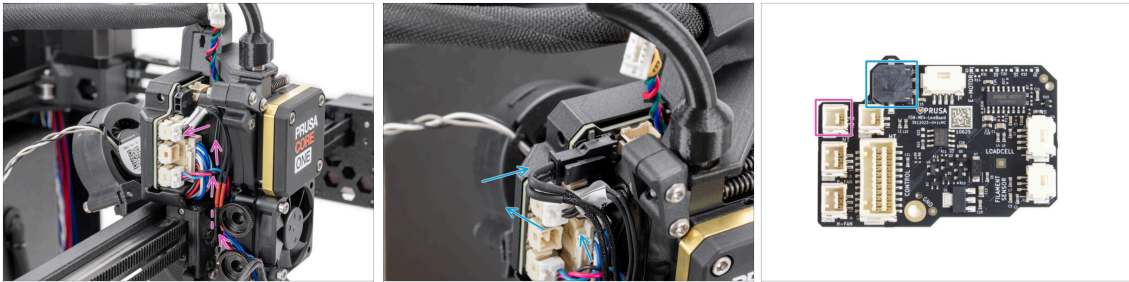

- ◆ Guide the hotend thermistor through the cable-clip on the Nextruder and connect it to the LoveBoard.
- ◆ Guide the hotend heater through the cable-clip on the Nextruder and connect it to the LoveBoard.

### STEP 32 Connecting the print fan cable

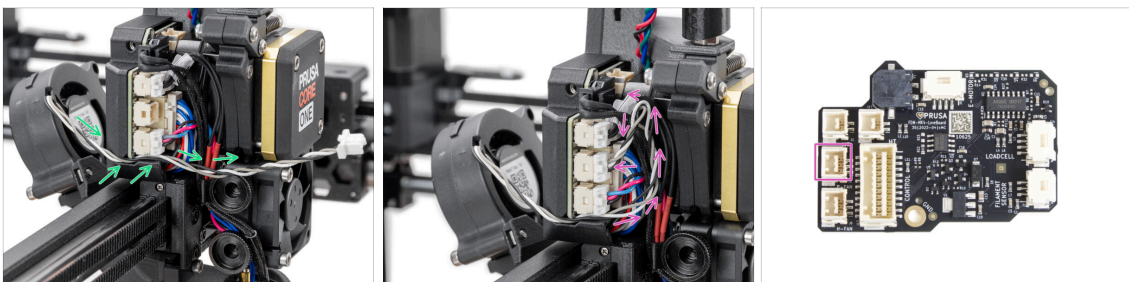

- ◆ Guide the print fan cable through the channel in the plastic cover.
- ◆ Create a loop with the print fan cable in the cable area and plug it into the middle connector in the LoveBoard.

### STEP 33 Connect E-motor cable

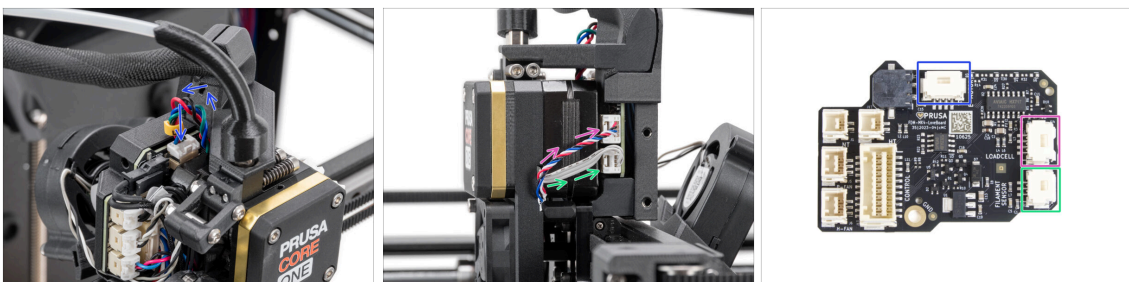

- ◆ Plug the Nextruder motor (labeled E) to the top-facing connector.
- ◆ Plug the loadcell cable (lower cable) to the upper connector on the right side of the Nextruder.
- ◆ Plug the filament sensor (upper cable) to the lower connector.

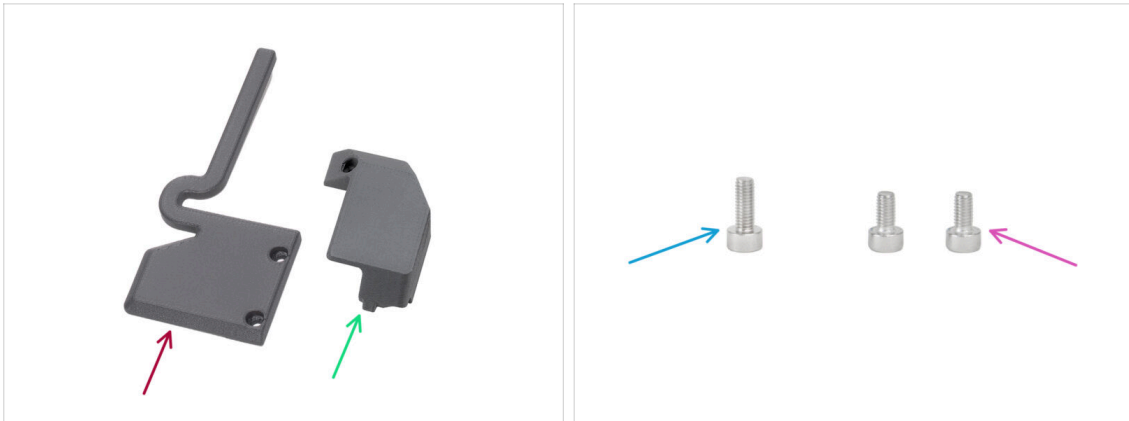
**STEP 34** LoveBoard covers: parts preparation

⬛ For the following steps, please prepare:

- 🟢 Printhead-cover-right-lever(1x)
- 🟠 Print-head-cover-right (1x) *found in the Printed parts package*
- 🟡 M3x10 screw (1x)
- 🟣 M3x6 screw (2x)

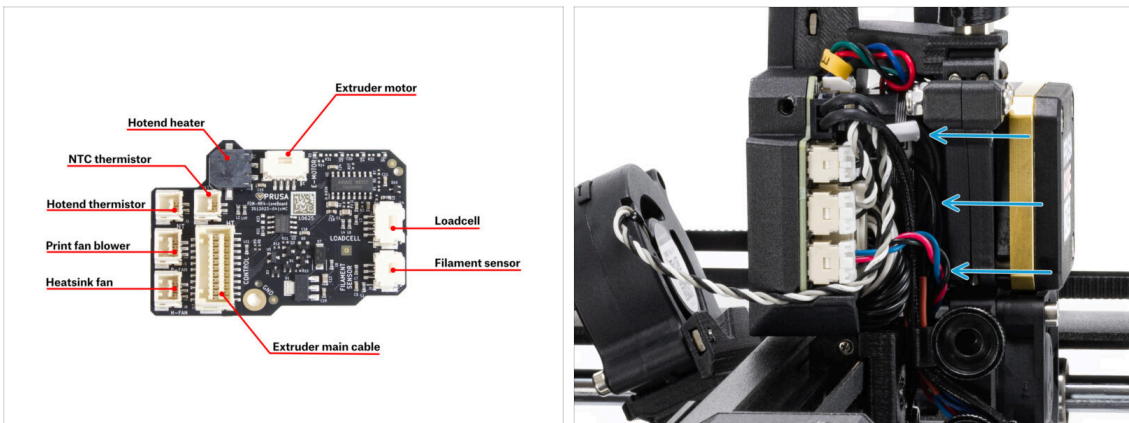
**STEP 35** LoveBoard: Wiring check

⚠ **Before covering the electronics, check the connection of all cables.**

📄 Click on the picture to open it in the high-resolution preview.

- 🟡 Squeeze the wiring harness as far inward to the LoveBoard as possible so that it does not protrude out and interfere with the fitting of the cover.

**STEP 36** Covering the LoveBoard

- 🟡 Attach the Print-head-cover-left on the left side of the Nextruder.
- 🟢 Secure the cover with one M3x10 screw.
- 🟠 Place the Printhead-cover-right-lever on the right side of the Nextruder.
- ⚠️ **Do not pinch the cables!**
- 🟣 Secure the cover with two M3x6 screws.
- 🟢 Guide the main-cable through the upper hole on the right side of the back panel assembly.

Leave the end of the cable hanging freely for now.

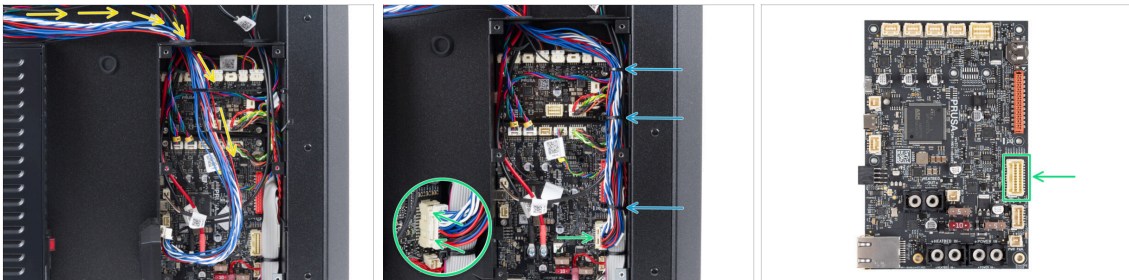
**STEP 37** Guiding the main cable

- ⬛ Rotate the printer so that the backside faces you.
- 🟡 Route the main cable through the left hole into the xBuddy box.
- 🟢 Plug the main-cable to the slot on the right side of the xBuddy board.
- 📄 ⓘ If the cable does not reach the connector or is too tight, go back to step Guiding the main cable and pull the cable slightly downward from the main-cable-clip.
- 🟢 Secure the cables with the pre-threaded zip ties in the xBuddy box. Carefully cut the excess, **avoiding cutting the cables.**

### STEP 38 Haribo time

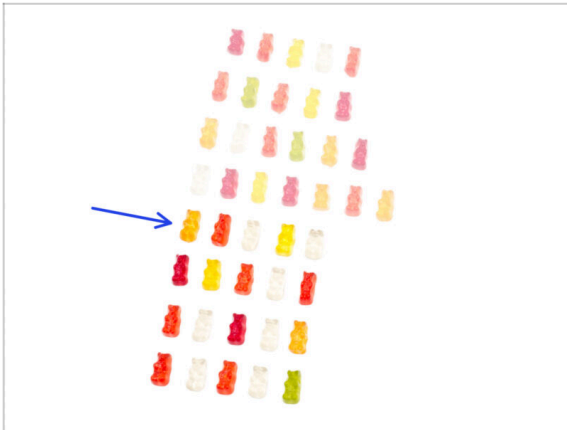

- Power up and push forward!
- Eat the fifth row.
- Not full yet?

---

### STEP 39 Done



- Congratulations! You just successfully assembled the Nextruder.
- Let's move to the next chapter.

## 7. Bodywork & Electronics

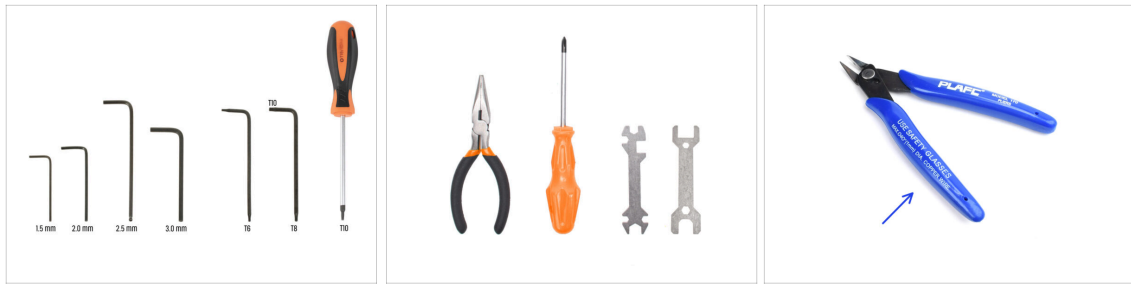

**STEP 1** Tools necessary for this chapter

● For the following steps, please prepare:

- 2.5mm Allen Key
- 1.5mm Allen Key
- T10 Torx Key
- Needle-nose Pliers
- Flush Cutters (Optional)

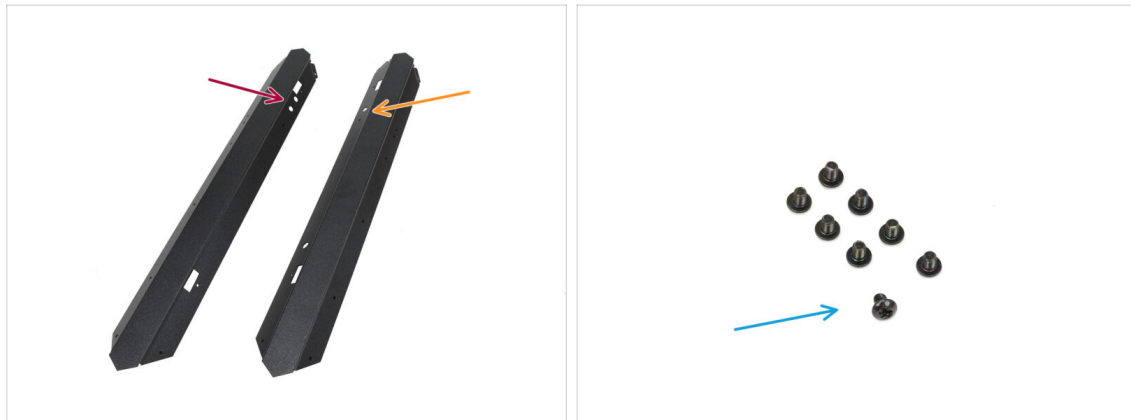
**STEP 2** Front profiles: parts preparation

● For the following steps, please prepare:

- Front Left Profile (1x) *found in the Metal parts 1/3 package*
  - ⓘ The one with the two circular openings on top.
- Front Right Profile (1x) *found in the Metal parts 1/3 package*
  - ⓘ The one with one circular opening on top.
- M3x4rT screw (8x)

### STEP 3 Installing the front right profile

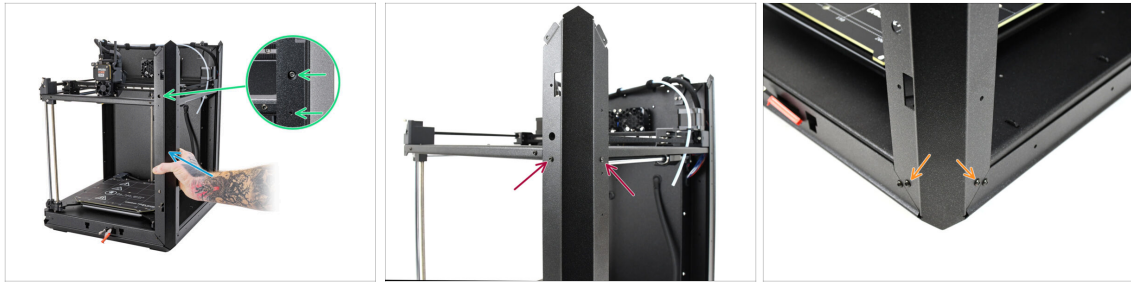

- ◆ Attach the Front Right Profile to the printer.
  - ⓘ Ensure you are using the correct profile—it should have **one large round opening** for the belt tensioning screw.
- ◆ Align the profile so that the calibration screw opening and the smaller bolt opening line up with the thread.
- ◆ Secure the profile to the CoreXY assembly using two M3x4rT screw
- ◆ Fix the profile at the bottom using the two M3x4rT screws.

### STEP 4 Installing the front left profile

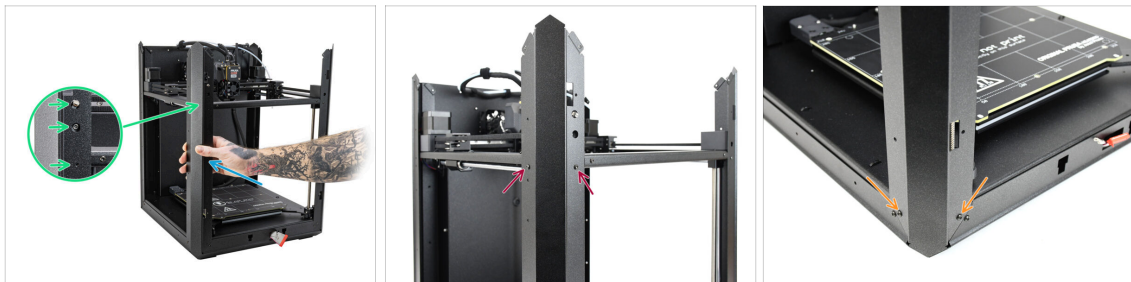

- ◆ Attach the Front Left Profile to the printer.
  - ⓘ Ensure you are using the correct profile—it should have **two large round openings** for the door sensor and the belt tensioning screw.
- ◆ Align the profile so that the openings match. **Be careful not to bend the door sensor lever!**
- ◆ Secure the profile to the CoreXY assembly using two M3x4rT screw
- ◆ Fix the profile at the bottom using the two M3x4rT screws.

## STEP 5 Top profiles: parts preparation

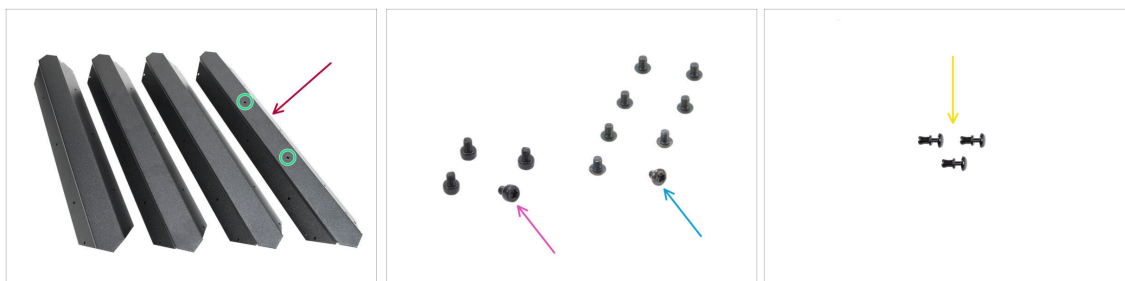

- Top Profile (4x) *found in the Metal parts 1/3 package*
  - Note that one of the profiles has two openings in the middle—this one belongs at the back.
- M3x4rT screw (8x)
- M3x4 screw (4x) *with the different head type*
- Nylon Rivet (3x)

## STEP 6 Assembling the top profiles I.



- ⚠ Be very careful when handling sharp sheet metal parts to avoid injury or damage.
- According to the picture, place the top profile with two holes on the flat side.
  - Orient the part according to the picture. **Use the flange as a guide.**
- Place any other of the top profiles on the left side. Orient the part according to the picture. **Use the flange as a guide.**
- Attach the two profiles together.
  - ⚠ The flange of the front plate (blue arrow) must be inserted **under** the left universal profile (green arrow), not on top of it.
- Align the holes in both parts and join both parts together with the M3x4 screw.
- Using the same procedure, join the other two profiles to form a corner, securing them with an M3x4 screw.

## STEP 7 Assembling the top profiles II.



- ◆ Attach the corner profile assembly to the first one, aligning the holes on the flanges with the holes in the profiles.
- ⚠ Ensure the flanges are positioned **underneath** the profiles.
- ◆ Join the both profile assemblies using two M3x4 screws.

## STEP 8 Aligning the top profiles

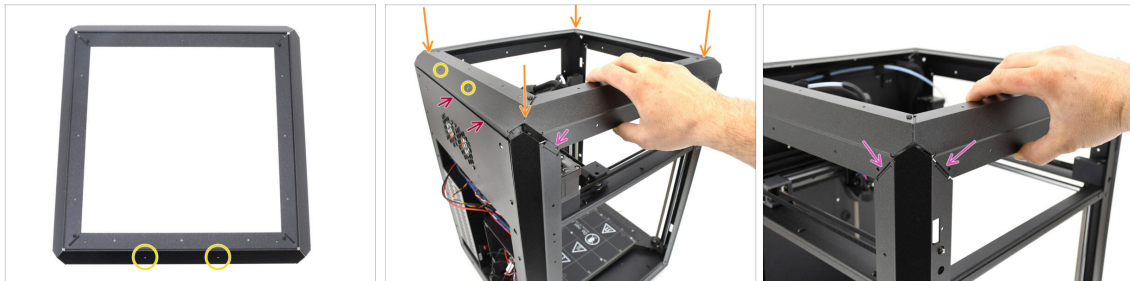

- ◆ Find the profile with **two openings in the middle**—this part should be positioned at the **rear of the printer**.
- ◆ Add the top profile assembly onto the printer, making sure the two openings are facing the back.
  - ◆ The protruding part of the rear profile must be positioned behind the back sheet metal plate.
  - ◆ On the sides and front, the profiles must sit on top of the tabs with threaded openings.

## STEP 9 Installing the top profiles



- Once all the top profiles are properly aligned, fix them in place using the remaining 8 M3x4rT screws in the corners.
- Attach the back panel to the top profile with three nylon rivets.

## STEP 10 CoreXY fixing screws: parts preparation



- For the following steps, please prepare:
- M3x4rT screw (4x)

## STEP 11 Fixing the CoreXY assembly



- Align the CoreXY assembly so the threaded holes match the screw openings in the rear profiles. You may need to push the assembly upward to align the holes.
- Fix the CoreXY assembly using the four M3x4rT screws in the marked openings.

## STEP 12 Side sensor base: parts preparation



- For the following steps, please prepare:**
- Filament-sensor-body (1x)
- Filament-sensor-lever (1x)
- Filament-sensor-switch (1x)
- M3x10 Screw (1x)
- 10x6x2mm magnet (2x) *found in the Electronics & Fasteners package*
- 7mm Ferromagnetic Ball (1x) *found in the Electronics & Fasteners package*
- M3w washer (1x)

**STEP 13** Assembling the side sensor base

- ◆ Insert one of the magnets into the dedicated opening in the Lever.
- ◆ Insert the ball into the corresponding opening on the inside of the sensor base.
- ◆ Insert the lever with the magnet into the Base.

ⓘ The part with the magnet should be positioned next to the ball.

Note that the ball will be attracted to the magnet—ensure it stays securely in place.

- ◆ Fix the lever in place using the M3w washer and M3x10 screw. Tighten it just a few turns for now—enough to hold it in place.

⚠ **Do not fully tighten the screw. Otherwise, the lever will not move and the sensor will not work!**

**STEP 14** Testing the lever

- ◆ Verify the lever is able to move freely.
- ◆ If the lever does not move freely or cannot move at all, loosen the screw by a quarter turn and test the movement again.

⚠ **The screw must not be fully tightened; otherwise, the lever will not be able to move freely.**

**STEP 15** Assembling the switch

- Insert the second 10x6x2 magnet into the filament-sensor-switch.
- Install the filament-sensor-switch into the filament-sensor-body.
  - Move the filament-sensor-switch to the left end position so the magnets face each other.
- Make sure **the magnets repel** - they should push away from one another.
  - **If they attract** - pull toward each other: remove the magnet from the filament-sensor switch and flip its polarity. Then check it again.
- ⓘ *Pro tip: Use one of the thin hex keys or Torx keys to remove the magnet from the filament-sensor-switch.*

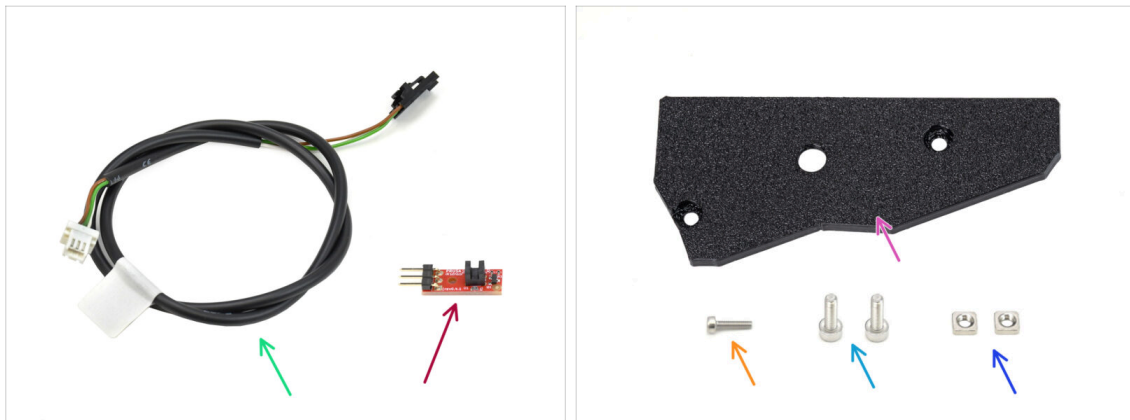
**STEP 16** IR Sensor: parts preparation

- **For the following steps, please prepare:**
- Side Filament Sensor Cable (1x) *found in the Electronics & Fasteners package*
- IR Filament Sensor (1x) *found in the Electronics & Chamber parts package*
- Side Filament Sensor Cover (1x) *found in the Printed package*
- M2x8 Screw (1x)
- M3x10 Screw (2x)
- M3nS nut (2x)

## STEP 17 Connecting the IR sensor



- ◆ Plug the cable into the IR filament sensor.
  - ⚠ **Ensure the connector is oriented correctly before plugging it in!**
  - ◆ On CORE One, the brown cable must connect to the +5V pin.
  - ◆ The white cable connects to the GND pin.

## STEP 18 Installing the IR sensor

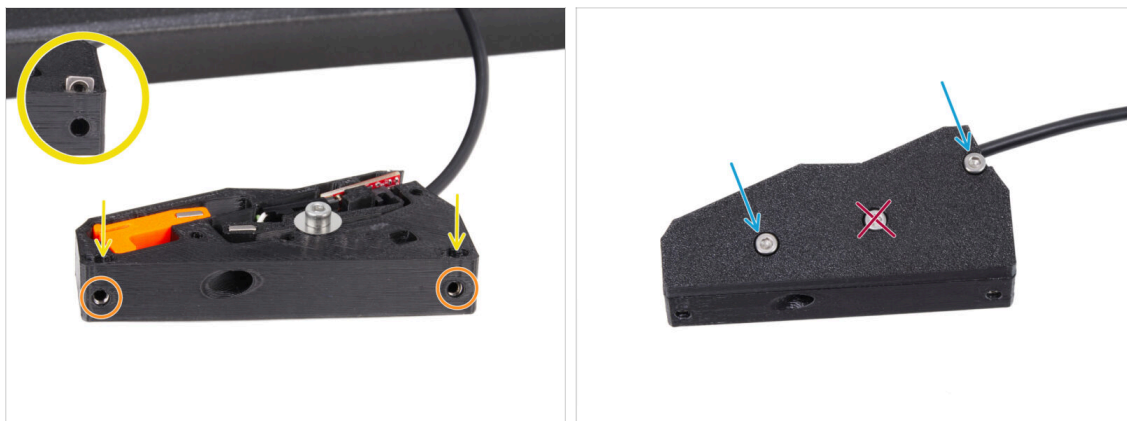

- ◆ First, insert the cable into the groove. The black connector should be approximately in the middle of the sensor base.
- ◆ Insert the IR sensor itself into the dedicated groove.
- ◆ The lever must fit into the optical gate part of the sensor.
- ◆ Make sure neither the connector nor the cables touch the lever, as this could prevent the sensor from functioning correctly.
- ◆ Using the 1.5mm Allen key, fix the sensor in place with the M2x8 screw.

**STEP 19** Installing the side sensor cover

- Insert the two M3nS nuts into the designated openings. Use a 1.5mm Allen key to **push them all the way in**.
  - Look from the side to ensure the threads in the nuts align with the openings.
  - Add the cover part onto the assembly.
  - Fix the cover in place using two M3x10 screws on the sides.
- ⚠ **Do not tighten the screw in the middle!** Otherwise, the sensor would stop working.

**STEP 20** Side filament sensor: parts preparation

- **For the following steps, please prepare:**
- Side Filament Sensor Assembly (1x) *you assembled earlier*
- Collet (1x) *found in the Electronics & Fasteners package*
- Zip-tie (3x)

**STEP 21** Installing the side filament sensor

- 🟠 Install one zip-tie into the marked openings. We will use it to attach a cable underneath the metal profile.
  - 🟡 Insert the collet into the marked opening on the sensor assembly.
  - 🟢 Attach the sensor assembly onto the PTFE tube in the printer.
- ⚠️ **Make sure to push the tube all the way in!**

**STEP 22** Guide the filament sensor cable

- 🟠 Move the sensor assembly up, roughly to the middle of the printer's frame, to align the cable properly.
- 🟢 Once in position, secure the cable underneath the metal profile using a zip-tie. Tighten the zip-tie lightly, allowing for cable adjustments if needed later. Cut off the excess zip-tie.
- 🟡 Guide the sensor cable through the dedicated opening to the back of the printer.
- 🟠 On the back of the printer, guide the cable into the xBuddy box. Leave it hanging loosely for now.

## STEP 23 Connecting the side filament sensor

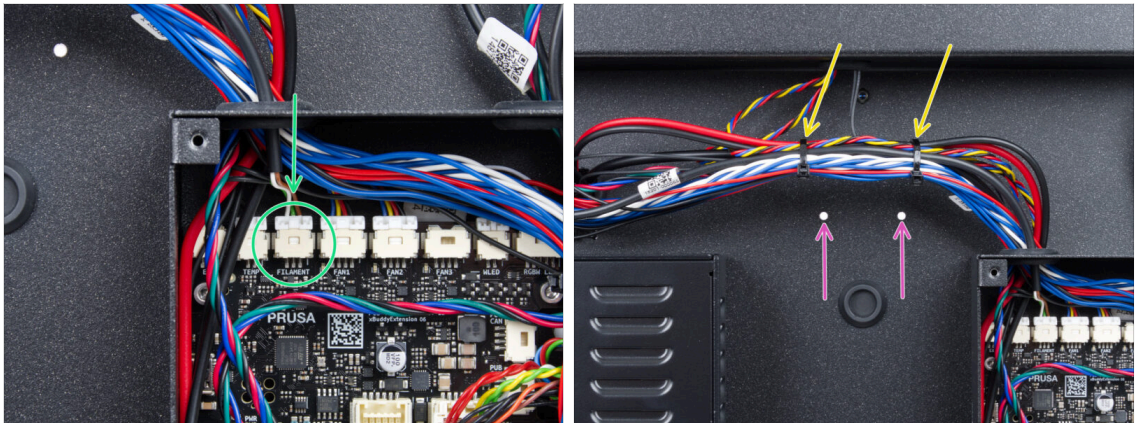

- ◆ Connect the Side Filament Sensor cable into the connector labeled FILAMENT on top of the xBuddy extension board.
  - i You can use needle-nose pliers to assist you, but be careful not to damage the cables.
- ◆ Use two zip-ties to clamp the cable bundle together in the marked area.
  - ◆ Secure the cables in the **highest possible position** to ensure they clear the two openings on the sheet metal below.
- ⚠ Do not over-tighten the zip ties or strain the cables too much!

## STEP 24 NFC Antenna: parts preparation

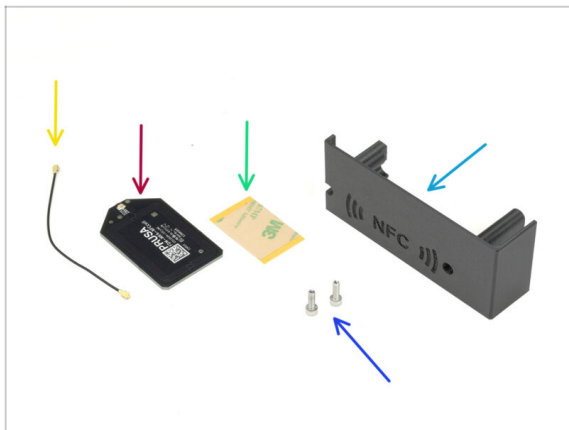

- ◆ For the following steps, please prepare:
  - ◆ El-box-cover (1x) found in the Printed parts package
  - ◆ M3x10 screw (2x)
  - ◆ NFCcoil (1x) found in the Electronics & Chamber parts package
  - ◆ Adhesive film 32 x 25 mm (1x) found in the Electronics & Chamber parts package
  - ◆ NFC coil cable (1x) found in the Electronics & Chamber parts package

## STEP 25 Applying the adhesive film



- ◆ Peel off the yellow protective film from the adhesive tape.
- ◆ Apply the film to the flat side of the NFC coil, ensuring it adheres properly.
- ◆ Peel of the remaining protective layer from the NFC coil.

## STEP 26 Installing the NFC Coil

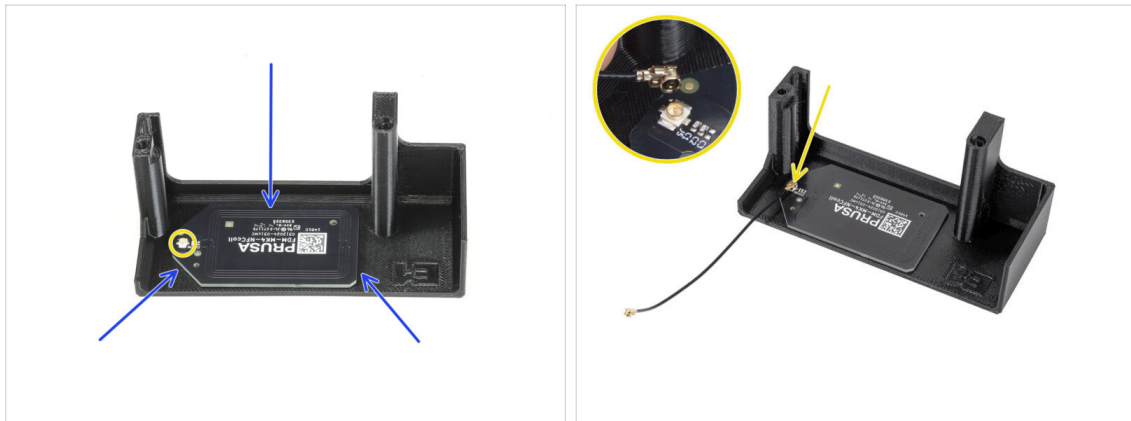

- ◆ Stick the NFC coil onto the inner side of the EI-box cover, approximately as shown in the picture.
- ⓘ The small round connector should be positioned closer to the edge of the cover.
- ◆ Connect the cable to the board by aligning the connectors and pressing lightly until you feel a click, ensuring a secure connection.
- ⚠ Be careful when connecting the NFC coil cable. Misalignment or excessive pressure can cause irreversible damage.

## STEP 27 Connecting the NFC Coil

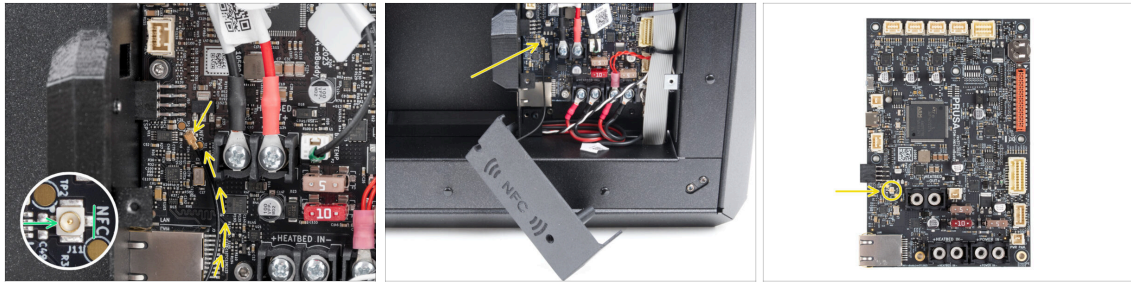

- ◆ Locate the small round connector labeled NFC on the bottom left side of the xBuddy board.
- ◆ Connect the NFC coil cable to the board by aligning the connectors and pressing lightly until you feel a click.

## STEP 28 Wiring check

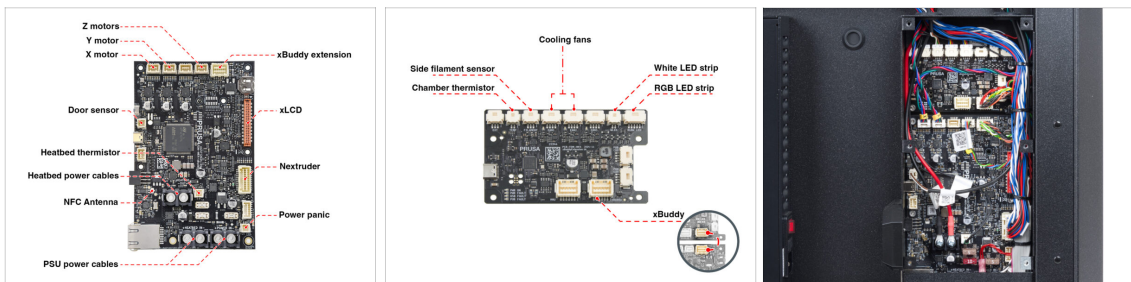

- ◆ Use the pictures as a reference to verify your electronics connections.
- ⚠ **Make sure that all connectors are fully inserted and PSU cables properly tightened. Otherwise, there is a risk of damage to the printer!**

## STEP 29 Preparing the electronics cover



- ◆ Push two M3x10 screws through the EI-box-cover.

## STEP 30 Installing the electronics cover

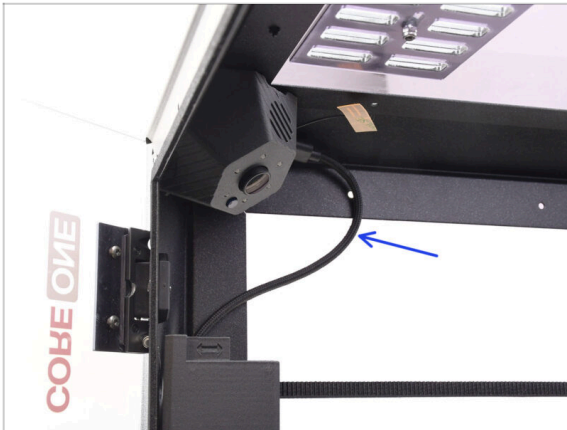

- Ensure the threaded holes on the bottom of the xBuddy box are not obstructed by cables.
- ◆ If so, rearrange the cables to allow clear access.
- ◆ Align the cover with the opening in the xBuddy box and fix it in place by tightening the screws.
- ◆ Route the NFC cable through the space between the Ethernet connector and the PSU power cables.
- ⚠ **Avoid running it through the Ethernet connector or the power cables. The cable may be damaged when covering the xBuddy box.**

**STEP 31** Buddy3D Camera Note

- i** For future Buddy3D Camera users:
- ◆** If you plan to use the Buddy3D Camera, you have the USB cable installed already.
- 📌** For detailed information on how to mount and connect the Buddy3D camera, return to this guide: **Buddy3D Camera for CORE One Installation**

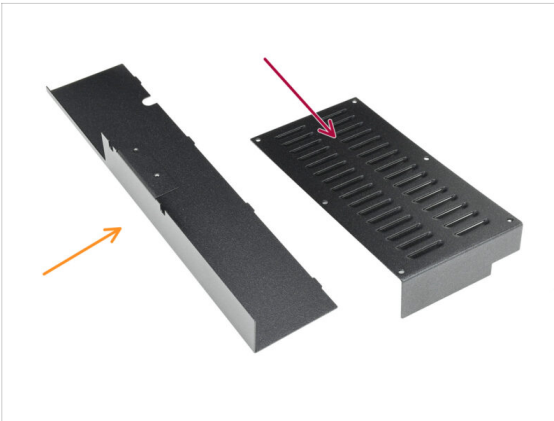
**STEP 32** xBuddy cover: parts preparation

- ◆** For the following steps, please prepare:
- ◆** Sheet metal back cover (1x) *found in the Metal parts 2/3 package*
  - ◆** xBuddy cover (1x) *found in the Metal parts 3/3 package*
  - ◆** M3x4rT screw (8x)

### STEP 33 Installing the xBuddy cover



- ◆ Arrange the cables inside the xBuddy box as shown in the picture.
- ◆ Carefully cover the xBuddy box by first sliding the bent part of the cover into the box.
- ⚠ **Avoid pinching the cables. Double-check the NFC coil cable position.**
- ◆ Secure the xBuddy box cover using the six M3x4rT screws.

### STEP 34 Installing the rear cover

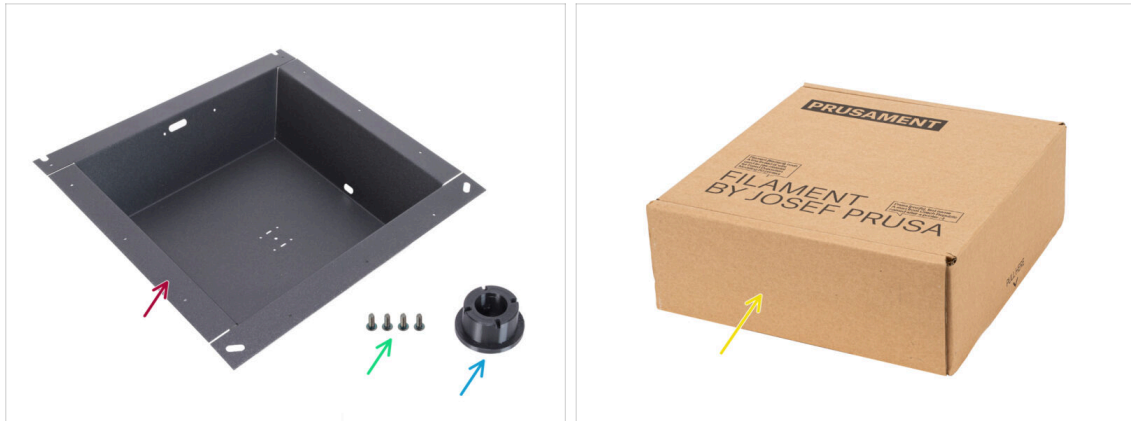

- ◆ Align the rear sheet metal cover so that the cables can run through the "tray".
- ◆ Place the rear sheet metal cover into the recess. Push it toward the printer, then move it upward to engage it.
- ◆ There are four tabs that should engage into the printer's chassis.
- ◆ Secure the rear cover in place using two M3x4rT screws from inside the printer.

**STEP 35** Right side: parts preparation

● For the following steps, please prepare:

● Right side sheet metal (1x) found in the *Metal parts 2/3* package

⚠ The correct **right-side** piece can be easily identified by the screw openings in the middle.

● M3x8rT screw (4x) found in the *Electronics & fasteners* package

● Puck-universal (1x)

● Any cardboard box (1x)

📌 *Tip: A Prusament box works well.*

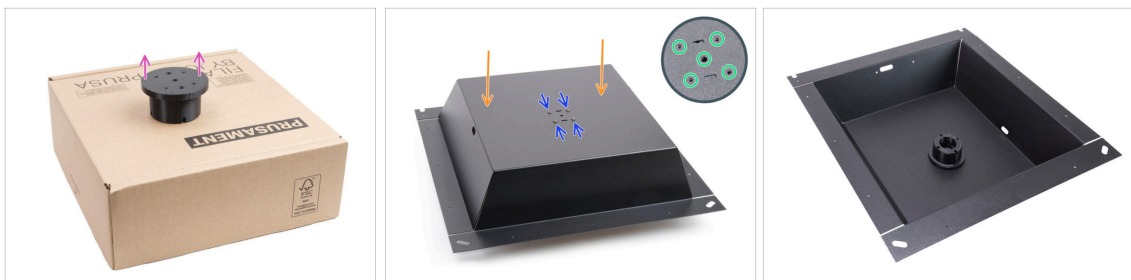
**STEP 36** Installing the spoolholder puck

● Place the Puck-universal on the cardboard box so that the screw holes face upward.

● Carefully place the right panel onto the Puck-universal, positioning it at the center of the box.

● Align the holes in the Puck-universal with the holes in the right panel.

● Fasten the Puck-universal using four M3x8rT screws.

ⓘ Screws may feel resistant when tightening, as they cut their own thread inside the part.

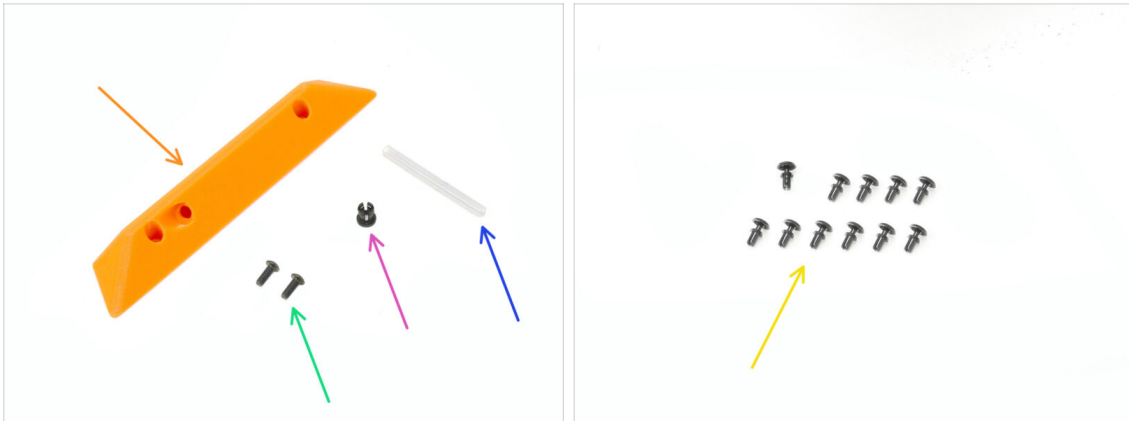
**STEP 37** Right handle: parts preparation

● **For the following steps, prepare:**

- Side Handle (1x) *found in the Printed parts package*
- M3x8rT screw (2x)
- Collet (1x) *found in the Electronics & Fasteners package*
- PTFE Tube 4 x 2.5 x 45 mm (1x) *found in the CoreXY parts + Hinges set package (together with hinges parts)*
- Nylon Rivet (11x)

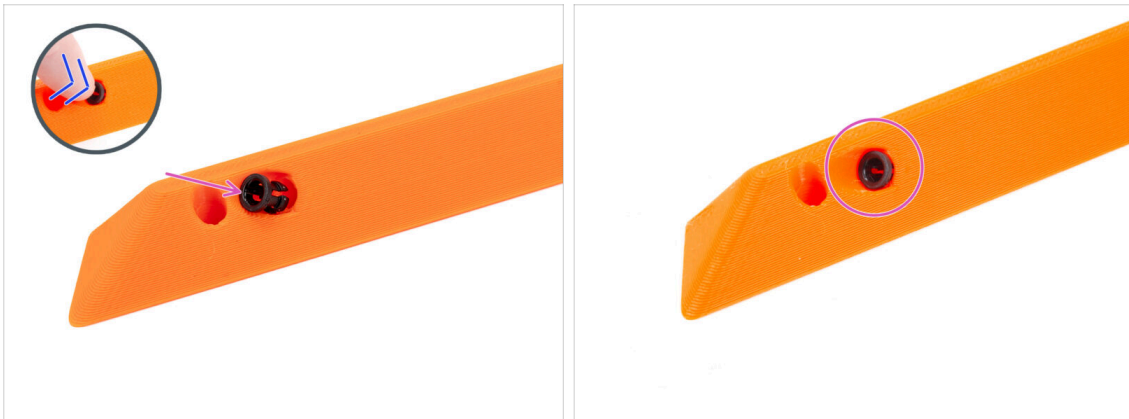
**STEP 38** Installing the collet

- Insert the collet into the handle.
- Push it all the way in.

## STEP 39 Mounting the handle



- ◆ Place the right-side metal sheet assembly on the right side of the printer. Ensure the U-shaped cutouts are facing upwards.
- ◆ Attach the right handle to the right metal sheet.
- ◆ Push one M3x8rT screw through the rear hole in the handle and the metal sheet.
- ◆ Attach the side filament sensor assembly on the screw.
- ⚠ **Do not pull the side sensor assembly too far; bring the right side metal sheet as close as possible.**
- ◆ Tighten the screw just slightly—the nut must remain free to move.
- ◆ Align the side filament sensor with the front screw hole in the metal sheet and the handle.

## STEP 40 Fixing the right side

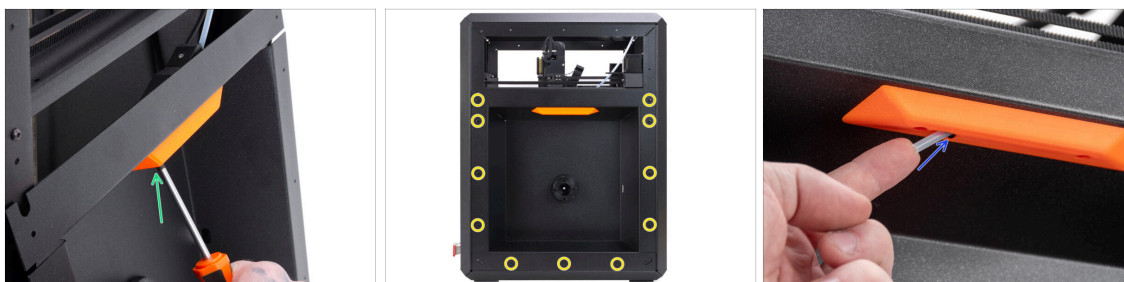

- ◆ Using the second M3x8rT screw, secure the right handle and the side filament sensor to the right metal sheet.
- ◆ Secure the side sheet metal to the printer using the 11 Nylon rivets.
- ◆ Insert the short PTFE tube 4 x 2.5 x 45 into the collet. Push it all the way in.
- ⓘ Part of the PTFE tube will remain protruding from the handle.

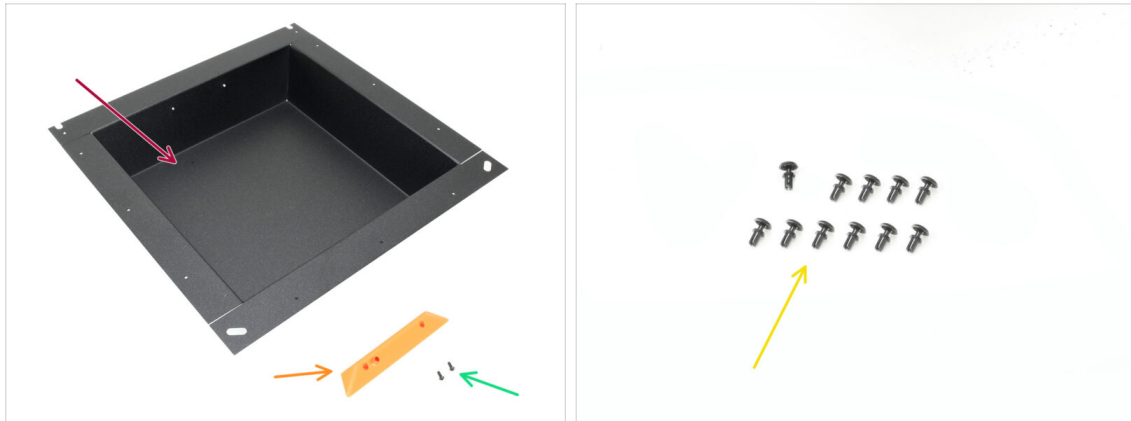
**STEP 41** Left side: parts preparation

■ **For the following steps, prepare:**

- Left side sheet metal (1x) found in the *Metal parts 2/3 package*
- Side Handle (1x) found in the *Printed parts package*
- M3x5rT screw (2x)
- Nylon rivet (11x)

**STEP 42** Installing the left side

- Align the handle with the threaded openings in the sheet metal.
- Attach the handle using the two M3x5rT screws.
- Secure the side sheet metal to the printer using 11 nylon rivets.

## STEP 43 Haribo time

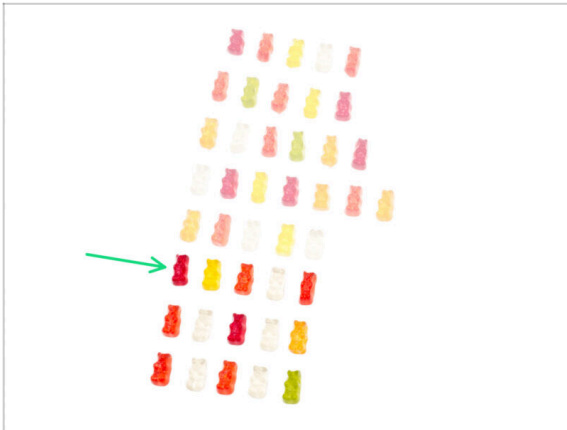

- Well done—fuel up for the next challenge!
- Eat the sixth row.
- So close! But **hands off those last gummies!**

## STEP 44 Done



- Congratulations! You've successfully assembled the entire body.
- Let's move to the next chapter.

## 8. Trim, Door & xLCD

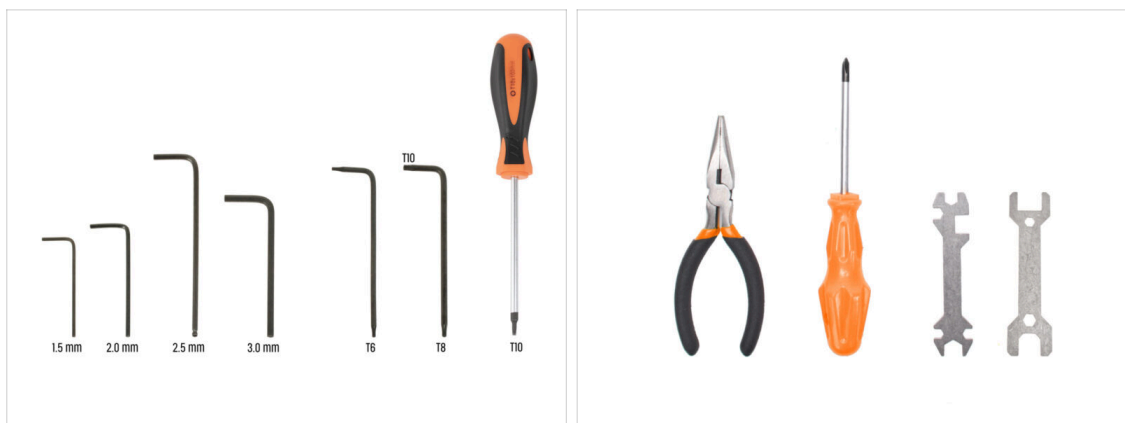

**STEP 1** Tools necessary for this chapter

- **For the following steps, prepare:**
- 2.5mm Allen Key
- T10 Torx Key
- Needle-nose pliers

**STEP 2** Top cover: parts preparation

- **For the following steps, prepare:**
- Top cover (1x) *found in the Plexi set package*
- Vent cover (1x) *found in the Plexi set package*
- M3nN nut (3x)
- Insulating insert (3x) *found in the Electronics & Fasteners package*
- ⓘ This part may come in either gray or black. However, the shape is identical, and it does not affect the procedure.
- M3x12rT screw (3x)
- Nylon rivet (4x)
- Upg-vent-block

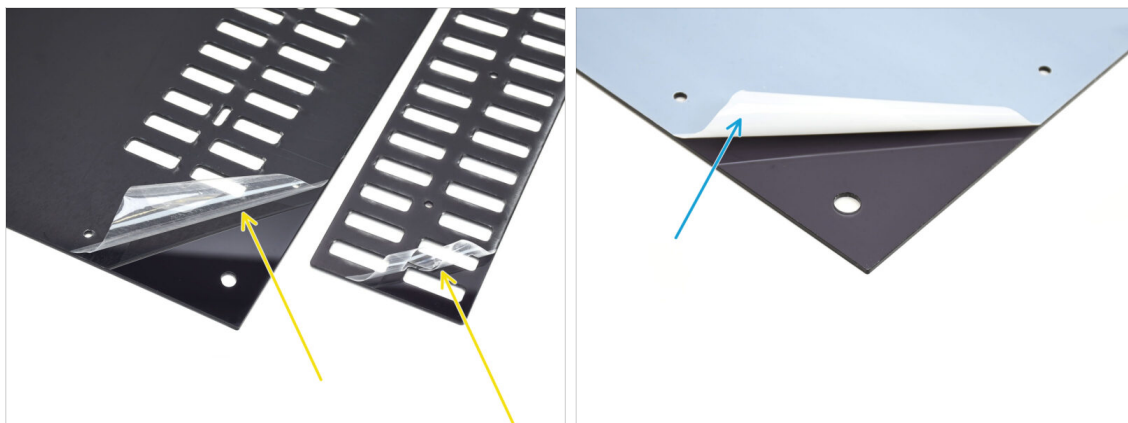
**STEP 3** Removing the foil

- First, remove the protection foil from both the plastic sheets.
- Flip the parts around and remove the protective foil from the other sides.

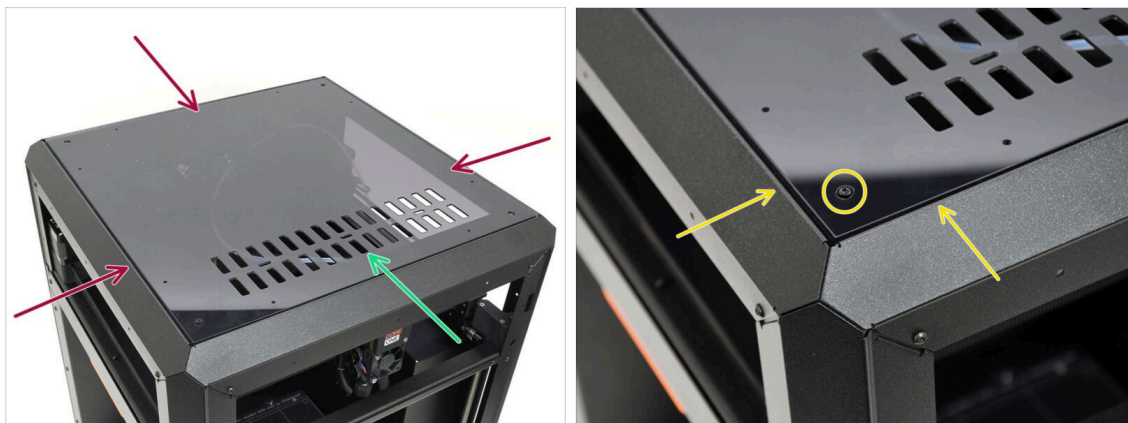
**STEP 4** Test-fitting the top cover

- Lay down the top cover onto the printer.
- The part with the vent openings should be oriented towards the front of the printer.
- If oriented correctly, the cover will align with the recess, and the bolt heads in the corners will fit into the cutouts.
- ⓘ If the bolt openings don't align, flip the cover.

Spoiler alert: The cover isn't symmetrical!

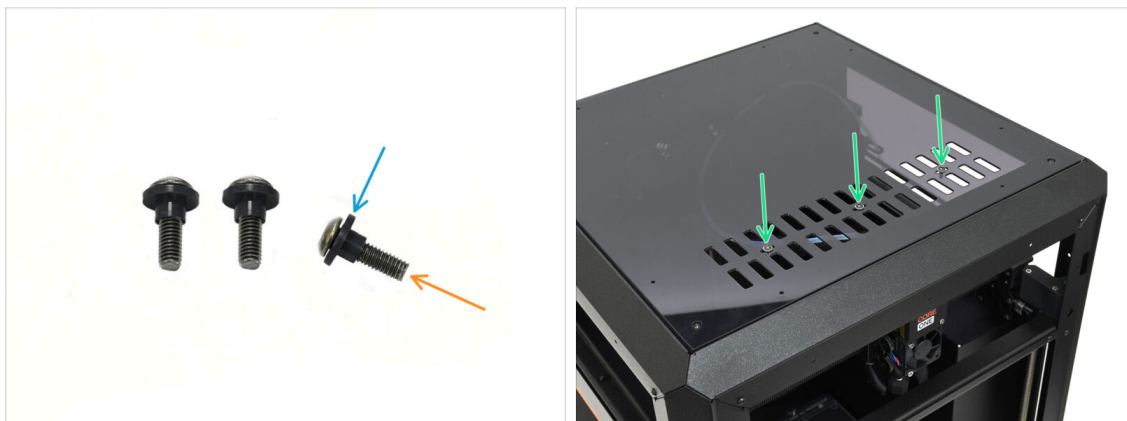
**STEP 5** Assembling the top cover I.

- Run all three M3x12rT screws through the insulating inserts.
- Make sure the flanged part of the insert is oriented toward the screw head.
- Insert the screws with the inserts through the three slot openings in the vent.

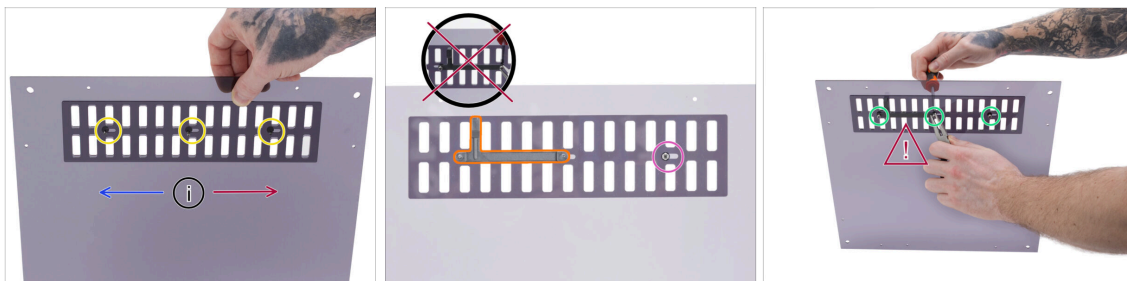
**STEP 6** Assembling the top cover II.

- Align the vent cover.
- ⓘ Note that the vent cover is not symmetrical; **ensure that it is positioned as shown in the photos.**
  - Sliding the vent cover to the left will open it.
  - Sliding the vent cover to the right will close it.
- Hand-tighten the rightmost M3nN nut onto the M3x12rT screw to fix the cover in place. Do not tighten it fully.
- Attach the Upg-vent-block to the ventilation cover. Make sure that it is positioned correctly. **Ensure that the vent block never overlaps with the opened vent.**
- ⓘ The Upg-vent-block **lever will face inside the printer** so that the printhead can open and close the vent cover.
- Secure the Upg-vent-block on the ventilation cover with M3nN nuts. Use the needle-nose pliers or universal wrench to hold the nuts while tightening the screws.
- ⚠ **The screw must be tight enough just to remove the slack. It must remain loose, or the ventilation cover can not open and close properly.**

## STEP 7 Testing the ventilation



- ◆ Try moving one of the three screws with your hand.
- ⓘ The vent openings must open and close smoothly without effort.
- ⚠ If movement is difficult, loosen the screw that is restricting it.

## STEP 8 Installing the top cover



- ◆ Align the cover with the recess on the printer, ensuring the vent points forward.
- ◆ Secure the cover to the frame using four nylon rivets in the marked openings.
- ⓘ There are eight openings, but four rivets should be sufficient.

## STEP 9 Side covers: parts preparation

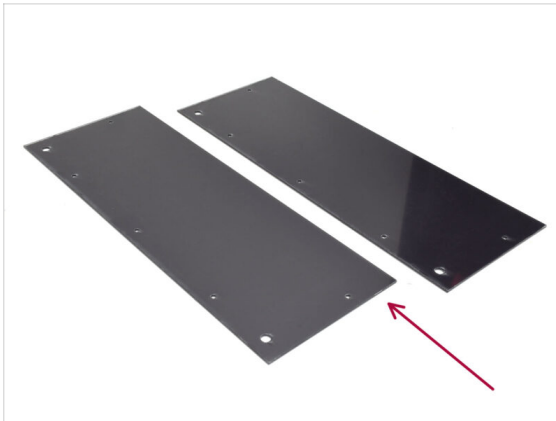

● For the following steps, prepare:

● Side Cover (2x) found in the Plexi set package

● Nylon Rivet (10x)

## STEP 10 Removing the foil

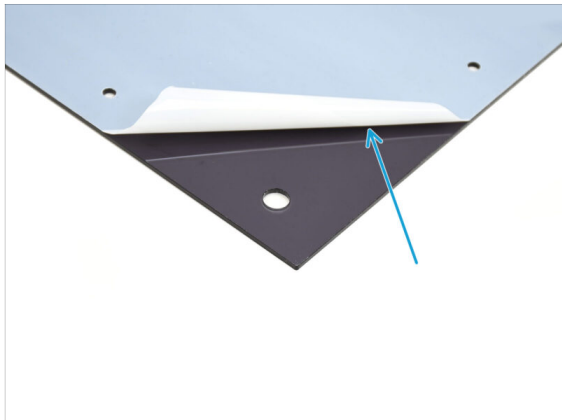
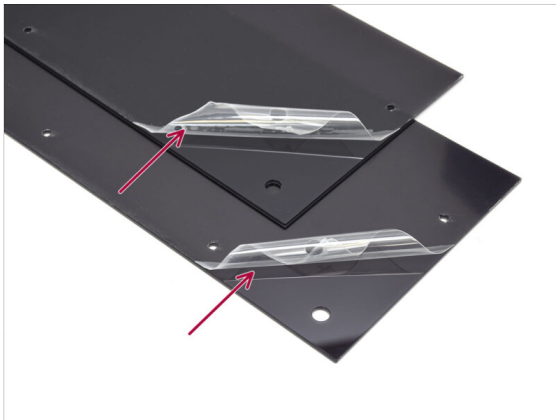

● Remove the protective foil from both the side covers.

● Remove the protective foil from the other sides of both the side covers.

### STEP 11 Covering the left side

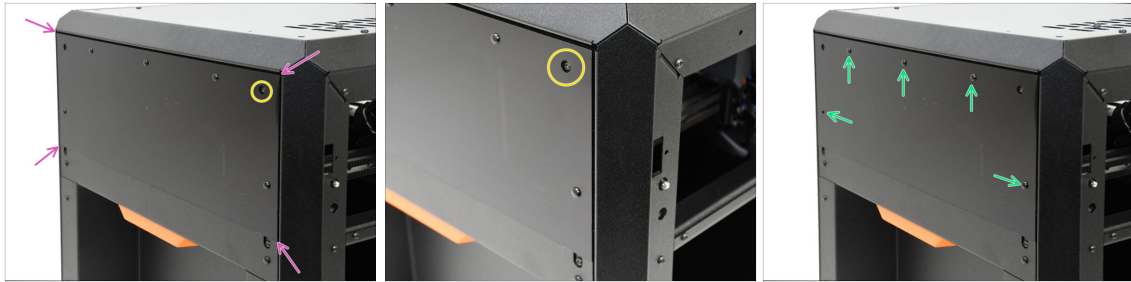

- Align the cover with the recess on the left side of the printer.
- The protruding screws on the printer must align with the larger openings in the cover.
- Secure the cover to the frame using five nylon rivets in the marked openings.

### STEP 12 Covering the right side



- Align the other cover with the recess on the right side of the printer.
- Secure the cover to the frame using five nylon rivets in the marked openings.

**STEP 13** xLCD: parts preparation

**For the following steps, prepare:**

**Orange hexagon:** xLCD (1x) *Prepare the part from the previous disassembly*

**Red hexagon:** xLCD Front Cover (1x) *found in the Printed parts package*

**Pink hexagon:** xLCD Display-mount (1x) *found in the Printed parts package*

**Information icon (i):** Note: Your kit may include the updated injection-molded xLCD Display Mount. Keep this in mind for the following steps.

**Green hexagon:** Knob (1x) *found in the Printed parts package*

**Blue hexagon:** 3x8sT Screw (4x) *Prepare the screws from the previous disassembly*

**Yellow hexagon:** Faston connector (1x) *Prepare the faston from the previous disassembly*

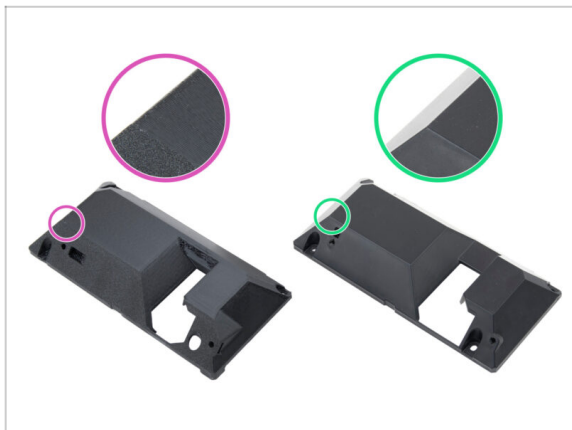
**STEP 14** Important: new xLCD display mount

**⚠** As of **March 2026**, the **xLCD Display Mount** has been updated. Your kit may include the new version.

◆ **Compare your part with the reference photo to identify the version:**

◆ **Older version** (3D-printed): Surface is rough and layered.

◆ **New version** (injection-molded): Surface is smooth.

ⓘ Changes related to the new part are detailed in the relevant steps of the manual. **Read carefully** and follow the instructions based on the version you have.

**STEP 15** Assembling the xLCD I.

- ◆ We recommend placing the front cover face down on a cardboard box edge or desk to create space for the encoder knob.
- ◆ Remove the protective foil from the xLCD.
- ◆ Insert the xLCD into the front cover.

**STEP 16** Assembling the xLCD II.

- ◆ Cover the assembly with the rear part.
  - ◆ If you have an older version of the printed rear cover, it must hook by the xLCD itself in the corner. With the up-to-date version, the rear part can be simply laid down.
  - ◆ Fix the parts together using **JUST THREE** 3x8sT screws in the marked openings.
    - ⚠ Do not insert the screw into the fourth opening next to the long slot for the xLCD connector, visible through the cutout. Leave it empty for now.

**STEP 17** Installing the FE Faston connector

- ◆ Let's move on to the fourth screw opening—this is where we will attach the grounding faston connector.
- ◆ Using needle-nose pliers, carefully maneuver the grounding faston connector over the screw opening, ensuring the holes line up.
- ◆ Secure the connector in place using one 3x8sT screw, making sure it stays lined up as indicated.
  - ⚠ To prevent damaging some of the surrounding electronic components, be careful and make sure the connector doesn't spin, while tightening it.

**STEP 18** Installing the LCD knob

- ◆ There is a flat part on the encoder shaft. Rotate the encoder so that the flat part is facing up.
- ◆ There is a small gate scar on the injection-molded knob, which can serve as an orientation mark.
- ◆ Attach the knob onto the shaft, making sure the mark on the knob is facing up.

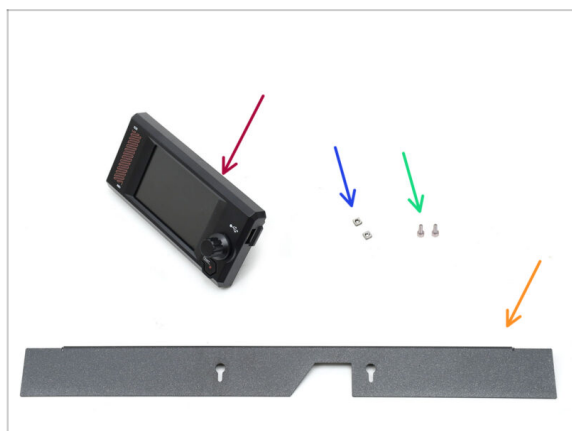
**STEP 19** xLCD bezel: parts preparation

- ◆ **For the following steps, prepare:**
- ◆ xLCD (1x) found in the *Electronics package*
- ◆ M3nS nut (2x)
- ◆ M3x6 screw (2x)
- ◆ Bezel (1x) found in the *Metal parts 2/3 package*

**STEP 20** Mounting the xLCD I.

- 🟠 For the **new injection-molded xLCD display mount**: M3nS nuts **are not used**.
- 🔵 Insert the two M3nS nuts into the dedicated openings on the back of the xLCD assembly,
  - 🟠 Push the nuts all the way in until the threads line up with the screw openings.
- 🔴 Attach two M3x6 screws into the openings. Do not screw them all the way in.
- 📄 **i** **New injection-molded xLCD display mount**: Screws thread directly into the plastic, so **slight resistance is normal**.
- 🟢 Leave a gap under the screw heads.

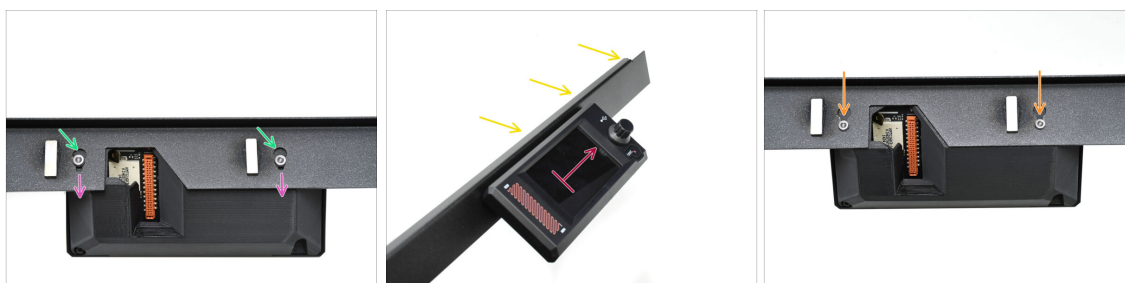
**STEP 21** Mounting the xLCD II.

- 🟠 Hook up the xLCD assembly onto the Bezel.
  - 🟢 Insert the screw heads into the keyhole openings.
  - 🟡 Slide the xLCD assembly so that the screw heads engage into the narrower parts of the keyholes.
- 🔴 If assembled correctly, the LCD should be pointing up...
  - 🟡 ...While the bent lip on the Bezel is on top.
- 🟠 Push the screws all the way into the narrow part of the keyhole on both sides. Then, tighten the screws.

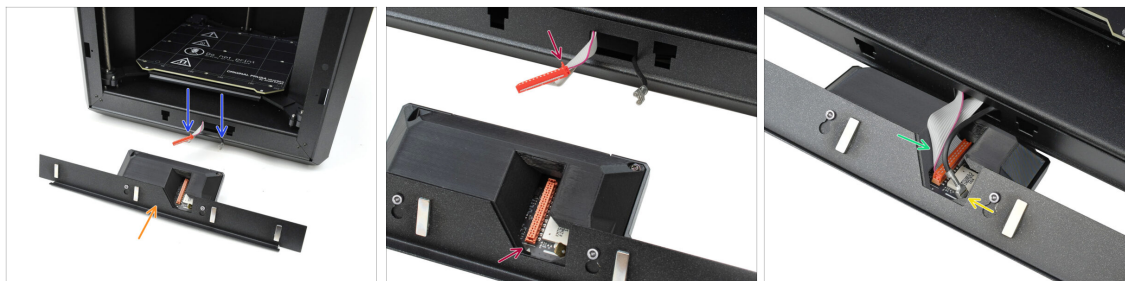
**STEP 22** Installing the xLCD assembly

- Put the xLCD assembly in front of the printer, as pictured.
- Pull the appropriate cables out from the front of the printer to make connecting them easier.
- There is a small red tab on the main connector. This tab must be oriented towards the triangle symbol on the PCB.
- Connect the main connector into the xLCD.
- Connect the grounding fastener connector.

**STEP 23** Securing the xLCD assembly

- Gently lift the xLCD assembly into the upward position.
  - ⚠ Proceed carefully to ensure none of the cables get pinched or disconnected.
- Hook the tiny tab on the left side of the bezel behind the left vertical profile of the printer.
- Gently lift the bottom part of the xLCD assembly to allow for smoother tab engagement and extra wiggle room.
  - Hook the tab on the right side into the printer's right profile.

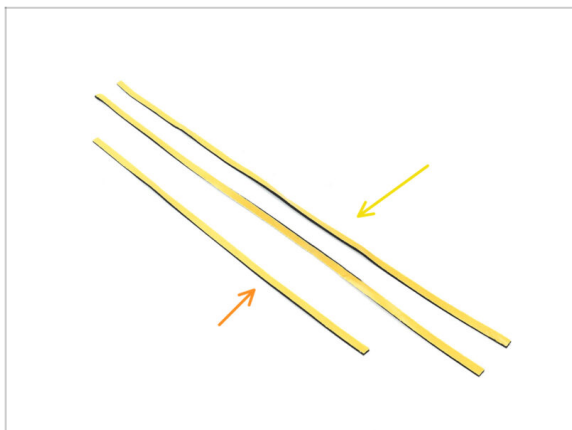
**STEP 24** Door seal: parts preparation

- ◆ **For the following steps, prepare:**
- ◆ Side door seal, a longer one (2x) found in the *Electronics & Fasteners* package
- ◆ Top door seal, a shorter one (1x) found in the *Electronics & Fasteners* package
- ⓘ The color of the protective layer may vary.

**STEP 25** Attaching the top seal

- ◆ Take the **SHORTER** seal.
- ◆ Peel off the start of the protective foil. No need to remove it entirely yet.
- ⓘ No need to remove it entirely yet. For easier installation, you can peel it off gradually as you go.
- ◆ Start applying the seal along the top edge of the printer's frame.
  - ◆ Begin offset from the corner by a distance equal to the seal thickness.
- ◆ Apply the seal along the top edge, leaving the end offset from the corner, just like on the other side.

**STEP 26** Attaching the side seals

- Apply the longer door seal, starting from the end of the seal on top.
- Work your way from the top down.
- ⓘ With needle-nose pliers, trim the excess.
- Using the same technique, apply the remaining long seal along the left edge of the printer's frame.

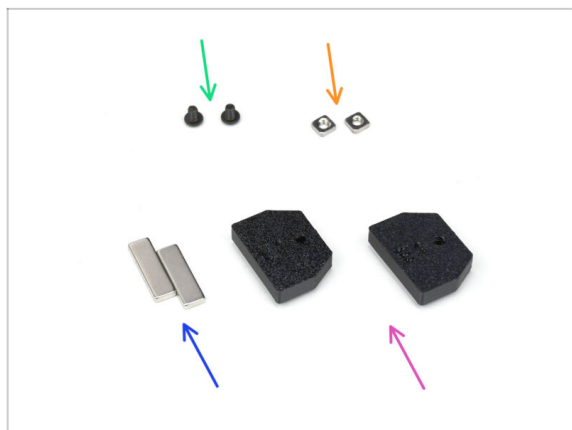
**STEP 27** Magnet holders: parts preparation

● For the following steps, prepare:

- M3x5rT screw (2x)
- M3nS nut (2x)
- 20x6x2 Magnet (2x) *found in the Electronics & Fasteners package*
- ⚠ **Keep the magnets apart at a sufficient distance. They can break each other!**
- Magnet Holder (2x) *found in the Printed parts package*

**STEP 28** Assembling the magnet holders

- 🟠 Insert the M3nS nuts into the corresponding openings in the magnet holders.
- 🔴 Push the nuts all the way in, until the thread aligns with the screw opening.
- 🟡 Insert the magnets into the corresponding pockets in the holders. Push them all the way in.
- 📄 **i** The orientation of the magnets does not matter.

**STEP 29** Installing the magnet holders

- 🟣 From the inside of the printer, insert the magnet holder assembly into the corresponding bottom opening in the right-side metal profile.
- ⚠️ **Ensure the protruding rectangular pocket fits into the cutout.**
- 🟢 Secure the assembly in place using the M3x5rT screw.
- 🟠 Using the same technique, install the other magnet holder into the top opening on the right side.

**STEP 30** Hinges: parts preparation

- ◆ **For the following steps, prepare:**
- ◆ Door-hinge-in (2x) found in the *CoreXY + Hinges set package*
  - ◆ Door-hinge-out (2x) found in the *CoreXY + Hinges set package*
  - ◆ Hinge Pin 2 x 40 mm (2x) found in the *Electronics & Fasteners package*
  - ◆ M3x5rT screw (2x)

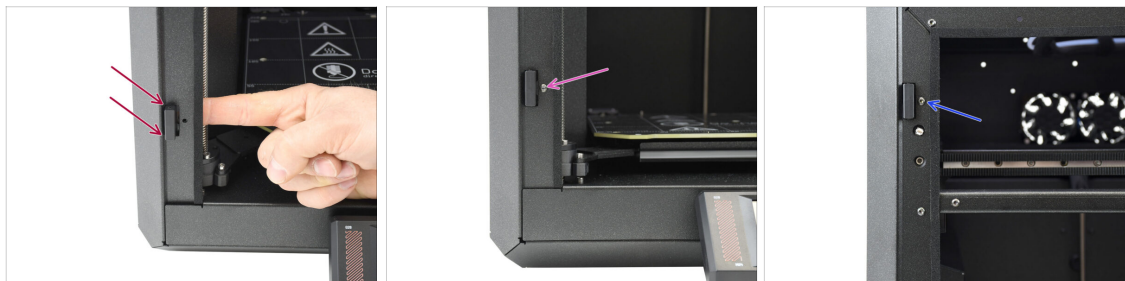
**STEP 31** Installing the door-hinge-in parts

- ◆ From the inside of the printer, insert the door-hinge-in into the bottom rectangular opening in the left-side profile. The protruding part should pass through to the front.
- ◆ Fix the door-hinge-in in place using the M3x5rT screw.
- ◆ Using the same technique, install the other door-hinge-in into the opening on top.

### STEP 32 Installing the door-hinge-out I.

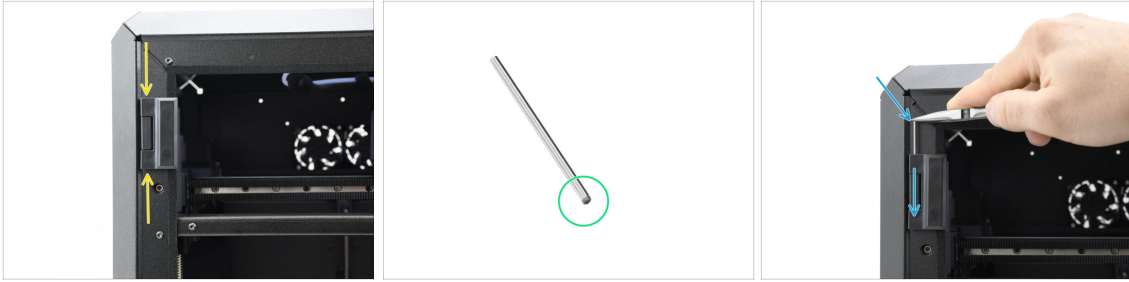

- ◆ Align the door-hinge-out with the door-hinge-in.
- ◆ The chamfered end of the hinge pin should be inserted first to make assembly easier.
- ◆ Insert the pin from the top of the door-hinge-out, guiding it through the door-hinge-in until it is fully inserted.
- ⓘ Use the tip of needle-nose pliers to press the pin in securely.

### STEP 33 Installing the door-hinge-out II.

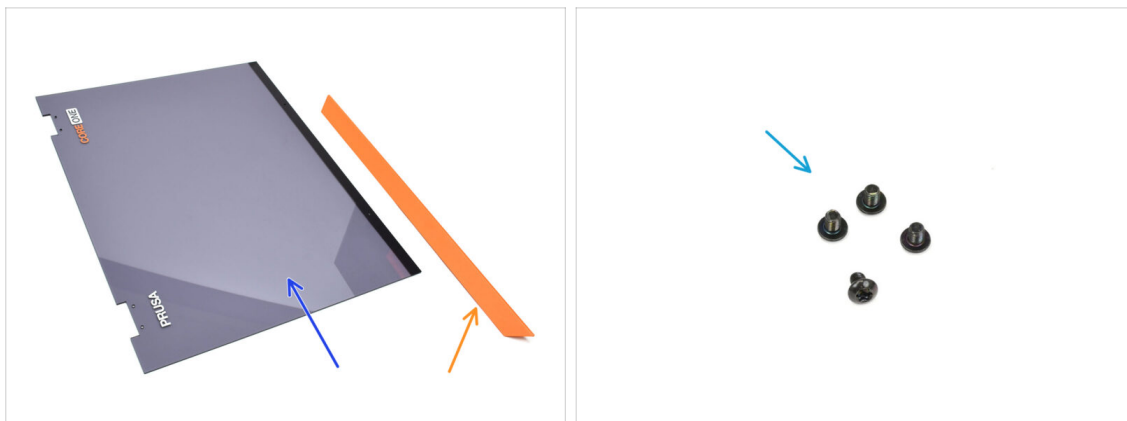

- ◆ Using the same technique, install the bottom door-hinge-out to complete the hinge assembly.
- ◆ Look into the grooves on the door-hinge-out parts and verify that the pins are fully inserted.  
No part of the pin should be visible above the bottom surface in the groove.
- ◆ Open up both the hinges.

**STEP 34** Door panel: parts preparation

● **For the following steps, prepare:**

- Door (1x) *found in the Plexi set package*

ⓘ The door panel is pre-labeled **CORE ONE**. Do not worry, **this is intended!** You will apply the upgrade + decal as the final step.

- Door handle (1x) *found in the Metal parts 2/3 package*
- M3x5rT screw (4x)

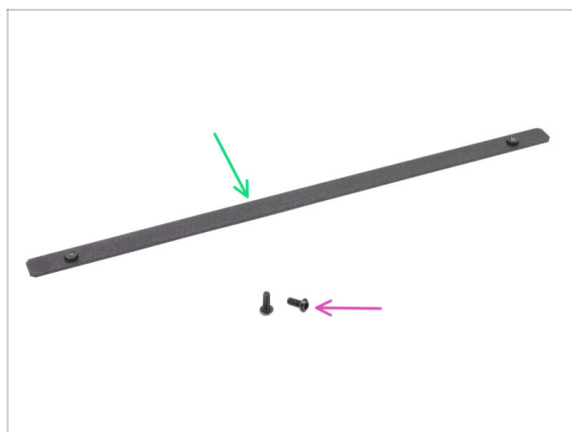
**STEP 35** Important: new parts

⚠ Starting **May 2026**, the door handle is supplied in a **screw-mounted version** (instead of the glued version).

- If your printer is from this period, **check the package contents**. If it includes parts for the screw-mounted version, you will find:

- Door handle plate (1x)
- M3x8rT screw (2x)

ⓘ You can still assemble the door handle using the glued method, but the screw-mounted version provides a more secure, long-lasting fit.

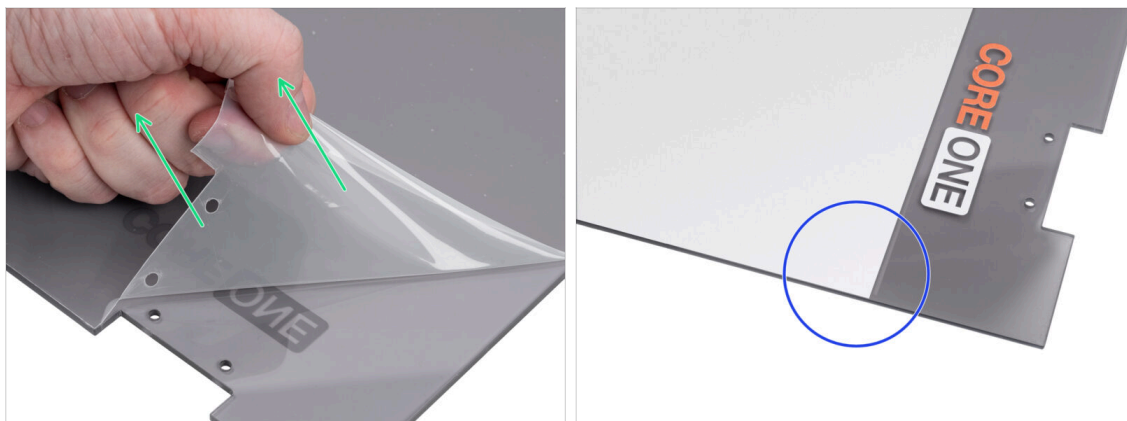
**STEP 36** Door panel: removing the protective film

- **The door panel has protective film on both sides.** One covers the entire surface, the other just the center area.
- Peel off the film covering the entire door; it's lightly transparent.
- You can remove the center protective film (white) now or after mounting the panel to protect the surface during handling.
- ⓘ This protective film does not interfere with the installation of the hinges or handle.

**STEP 37** Door handle installation method selection

- ⚠ **Do not continue until you identify the correct installation method based on the parts included in your package.**
- Continue with the section corresponding to your printer version:
  - If your printer includes a **door handle plate**, continue by pressing **Next** button.
  - Otherwise, **continue to Installing the door panel.**

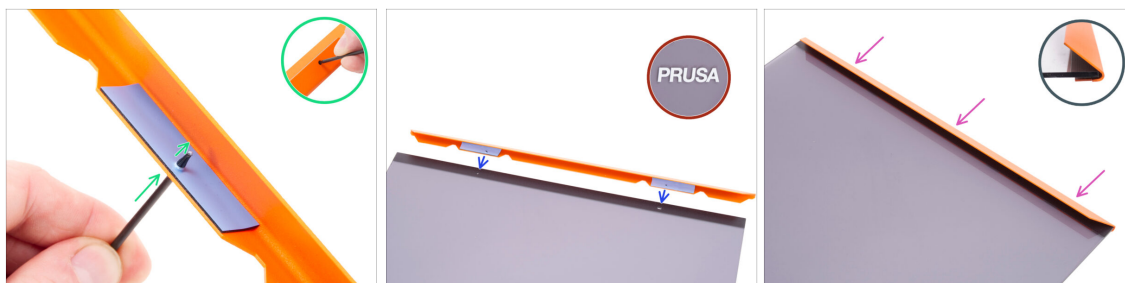
**STEP 38** Installing the door handle (screw-mounted)

- Take the door handle.
- Use a thin T6 Torx key to pierce the adhesive layer through the screw hole from the underside of the door handle.
- **Proceed the same on the second hole.**
- Place the door handle next to the door panel, as shown in the picture.
- ⚠ **Make sure the Prusa logo is now on the top side.**
- Align the holes in the door handle with the holes in the door panel.
- Slide the door handle onto the panel.

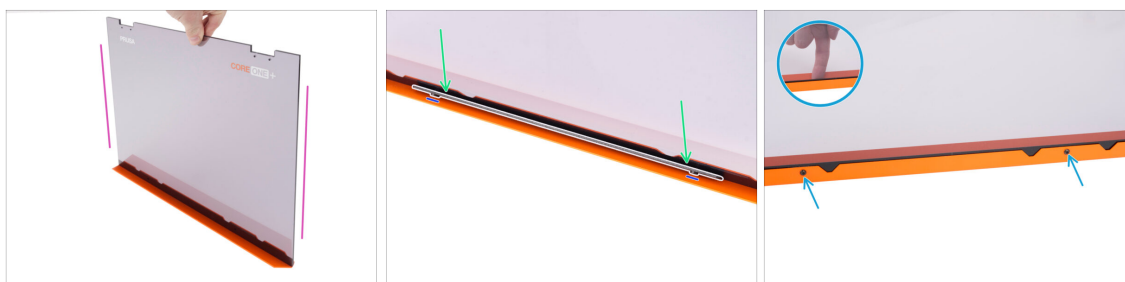
**STEP 39** Securing the handle (screw-mounted)

- Lift the door panel into a vertical position and hold it steady.
- Insert the door handle plate into the grip side of the handle (the outward-tilting side).
- Make sure the threaded columns on the plate face **away from the panel**.
- Align these columns with the screw holes in the door panel and the door handle. Secure the handle with two M3x8rT screws. Tighten firmly, but gently.
- ⓘ Some following steps may also describe a glued installation method for the door handle. Since your door handle is already installed using the screw-mounted version, **these instructions do not apply to this assembly**.

**STEP 40** Installing the door panel

- ◆ Align the door with the hinges. The cutouts on the door should fit into the grooves on top and bottom of the leaves.
- ◆ Make sure the door is oriented so that the signs on the door are pointing outward.
- ◆ Slide the door all the way into both the hinges.
- ◆ Fix the door to the hinges using four M3x5rT screws. Start with the top one. Then, do the bottom.

**STEP 41** Assembling the door handle (glued version)

- ⚠ This step includes an **adhesive (glued) mounting method only**. If your door handle is already screw-mounted, this step does not apply to your assembly.
- ◆ Let's move onto the handle. Remove the protective foil from both the adhesive strips on the inside.
- ◆ The part with the adhesive strip will go onto the back of the door. But do not attach the handle yet!
- ⚠ **Wait for the upcoming step! We have to align the handle first!**

**STEP 42** Securing the door handle (glued version)

**⚠** This step includes an **adhesive (glued) mounting method only**. If your door handle is already screw-mounted, this step does not apply to your assembly.

- 🟡** Align the handle so that the front chamfered part is flat to the door. The top of the handle must be flush with the door.
- 🟢** While pushing the handle against the door to keep it aligned, slowly rotate it counterclockwise until the adhesive strips bond to the door.
- 🟠** Push the door and handle together firmly in the adhesive strip areas to ensure a secure attachment.

**STEP 43** Attaching the sticker: Parts preparation

**📌 Note:** From 01/2026, the "+" symbol comes pre-installed on the printer door. If your printer is from an earlier date and **does not have the symbol**, follow this step.

- 🟢** For the following step, prepare:
  - 🟠** CORE One+ plexi sticker
- 📘** The CORE One+ plexi sticker is in the CORE One+ Upgrade box

### STEP 44 Attaching the sticker



- ◆ Remove the sticker from the blue base.
- ◆ Align the sticker with the **ONE** and gently but firmly apply pressure on the sticker.
- ◆ Carefully peel off the transparent layer and make sure that + is not peeling off.

### STEP 45 Haribo time

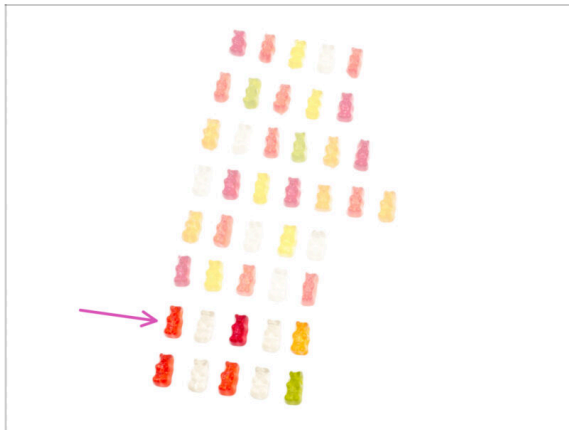

- ◆ Hard work deserves sweet results!
- ◆ Eat the seventh row.
- ⚠ But don't eat the rest yet.

---

**STEP 46** Done



- ◆ Congratulations! You have successfully assembled your Prusa CORE One+.
- ◆ Let's move to the final chapter.

# 9. Calibration & First run

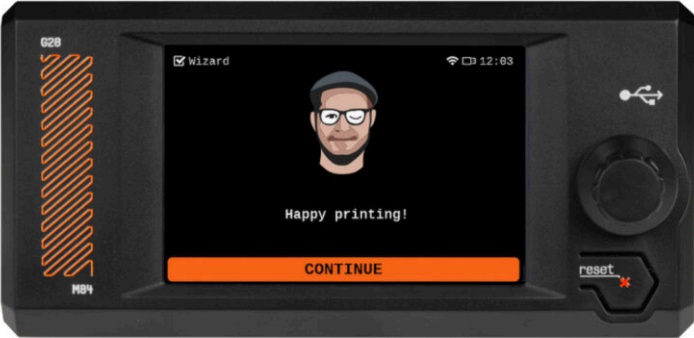

## STEP 1 Belt tensioning

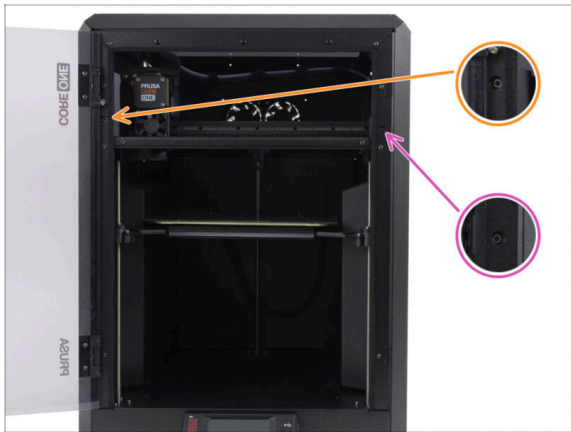

**i** This chapter will guide you through calibrating and preparing the printer for its first run. Starting with tensioning the belts:

**🟠** The left screw adjusts the upper belt.

**🟡** The right screw adjusts the lower belt.

**⬛** Double-check that the M3x30 screws in the belt tensioners were lubricated during assembly.

**⚠️** **WARNING: Incorrect procedure may result in damage to plastic parts or seizing of screws. Before adjusting the belt tension, read the dedicated article:**

**⬛** **Adjusting belt tension (CORE One)**

**📌** Do not forget to come back here after adjusting the belts.

## STEP 2 Installing the spoolholder: Parts preparation



**⬛** **For the next step, prepare:**

**🟡** O-ring

**🟠** Spoolholder-static

**i** The Spoolholder-static and the O-ring are in the same bag.

## STEP 3 Attaching the print sheet and spoolholder



**⚠ Make sure there is nothing on the heated bed.** The heated bed must be clean. Any dirt can damage the surface of both the heated bed and the print sheet.

- **Attach the sheet by first aligning the rear cutout with the locking pins on the back of the heated bed.** Hold the sheet by the front two corners and slowly lay it down onto the heated bed - **watch your fingers!**
  - Keep the print sheet clean for optimum performance.
  - #1 cause of prints detaching from the print surface is a greasy print sheet. Use IPA (Isopropyl alcohol) to decrease it if you have touched its surface before.
- Put the O-ring onto the Spoolholder-static.
- Push the Spoolholder-static into the Puck-universal dock and lock it in by turning it clockwise.

## STEP 4 Firmware Download

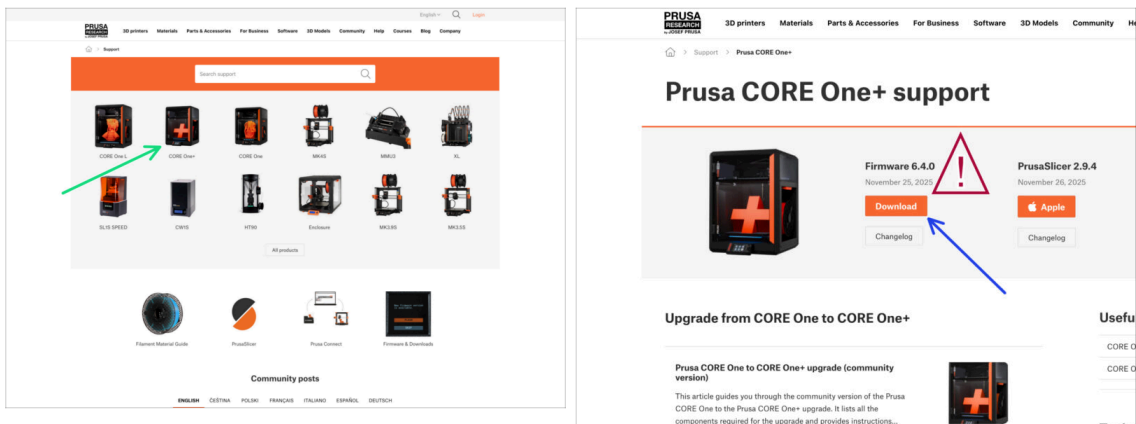

- We will have to upgrade the firmware.
  - ⚠ **The CORE One+ requires firmware version 6.4.0 or newer.** Make sure that your firmware is compatible before proceeding!
- To download the latest firmware, visit the **CORE One+ support page on help.prusa3d.com.**
- Download the latest firmware file (.bbf). Save the file onto a USB drive.

**STEP 5** Turning on the printer

- ◆ Insert the USB drive included in your kit into your printer.
  - ⓘ The included USB drive contains the latest firmware file.
- ◆ Connect the power cable and plug the printer into a wall outlet.
- ◆ Turn the printer on using the switch on the back.
- ⓘ The printer will now detect if a new firmware file is available on the USB drive.
- ◆ If the "New firmware available" screen appears, hit **FLASH** by pressing the rotary knob to upgrade to the latest firmware.
  - ◆ If no such message appears, the printer is running the latest firmware already. Proceed to the next step.

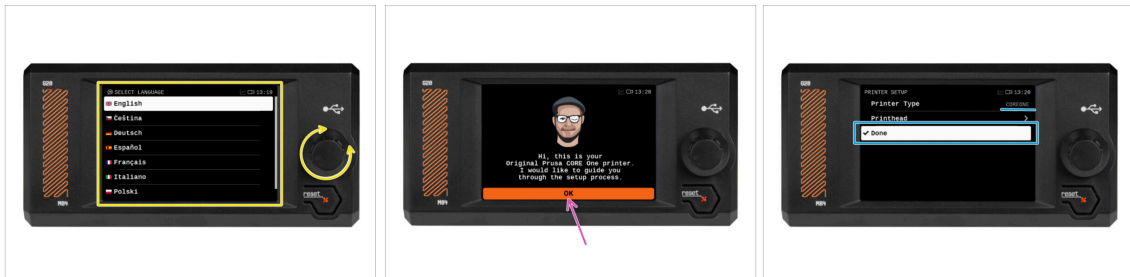
**STEP 6** Setting up the printer: Intro

- ◆ The printer displays on the screen a prompt to select your language. Use the control knob or touchscreen to set your preference.
- ◆ After selecting your language, the printer will display the welcome screen. Hit **OK** to continue through the setup process.
- ◆ The next screen will prompt you to select your printer model COREONE. Hit **Done** to continue.

## STEP 7 Setting up the printer: Network setup



- ◆ The Network Setup screen will ask you to connect to a Wi-Fi network using our official Prusa mobile app.
  - i Read more on [prusa.io/app](https://prusa.io/app).
- ◆ If you select **No**, the printer will show alternative ways to connect to Wi-Fi. This step is optional and can be done later.
- i You can skip this screen and set up the network connection later.

## STEP 8 Wizard: Intro



- i The printer will prompt you to run self-tests and calibrations for all important components. The entire process takes a few minutes, with some parts requiring direct user interaction.
- ◆ Hit **YES** to begin the self-test and follow the instructions on screen.
- ⚠ **During the self-test, keep the door closed until you are prompted. Opening the door will interrupt the process.**
- ◆ **There are HOT and moving parts inside during the self-test.**
- ◆ The printer will begin by testing all the fans. **Be aware—it can get quite noisy for a while!**

## STEP 9 Wizard: Door Sensor Calibration



- ◆ The first part that requires your interaction is the door sensor calibration. To begin, hit **Calibrate** and follow the on-screen instructions.
- ◆ You'll be prompted to gradually tighten the sensor tension screw from its default loose position - usually in half-turn steps, possibly several times during calibration.
  - ◆ After each adjustment, observe the door sensor switch emerging from the front profile hole.
  - ◆ Repeat the procedure until the door sensor is correctly adjusted - meaning it switches at a hand-gap distance. Then hit **Continue**.
- ⓘ Once the sensor is properly calibrated, you should hear an audible click from the door sensor area when opening and closing the door.

## STEP 10 Wizard: Loadcell Test



- ◆ The next step of the wizard will prompt you to touch the nozzle to test and calibrate the Loadcell. During this procedure, the **parts of the printer are not heated up** so that you can touch them. Hit **Continue**.
- ⓘ Loadcell calibration requires the door to be open, as you must interact directly inside the printer.
  - ◆ Do not touch the nozzle yet, wait until prompted by the **Tap nozzle NOW** message.
  - ◆ Tap the nozzle from below. In case the Loadcell does not detect the touch, you will be prompted to repeat the step. Otherwise, you will see **Loadcell test passed OK** when it succeeds.
  - ◆ To allow the printer to continue with the Wizard, **close the door**.

## STEP 11 Wizard: Gearbox Alignment

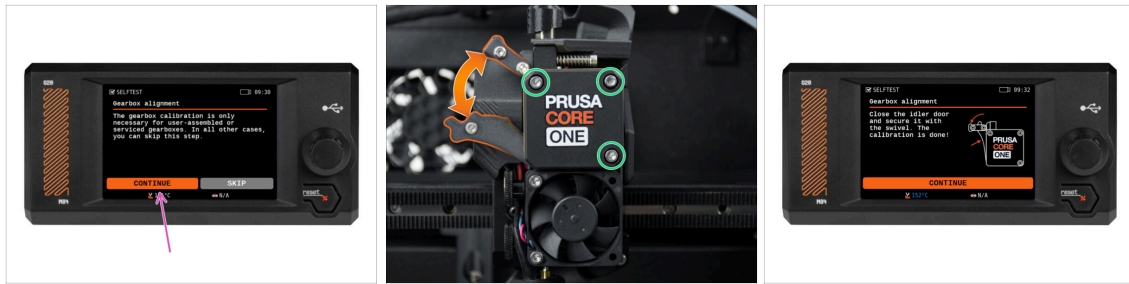

- ◆ Once you get to the Gearbox Alignment part, select **Continue** and follow the on-screen instructions.
- ◆ Make sure the idler lock (swivel) is unlocked from the idler door.
- ◆ Loosen the three screws on the front of the gearbox by 1.5 turns.
- ⓘ The printer will go through the automatic gearbox alignment. This process can't be seen from the outside.
- ◆ Once prompted, tighten the three screws in the pattern indicated on the screen.

## STEP 12 Wizard: Filament Sensor Calibration



- ◆ Check the manual switch on the filament sensor. **Make sure that it is ON.**
- ◆ During the filament sensor calibration, you will need to use a short piece of filament. Prepare the filament and select **Continue**.
- ⓘ There should be no filament inside the extruder before the calibration process starts.
- ◆ Place a spool of filament onto the spool holder on the right side of the printer.
- ◆ When prompted, begin inserting the filament into the PTFE tube located beneath the right handle.
- ◆ Remove the filament after the calibration finishes.

## STEP 13 Wizard complete

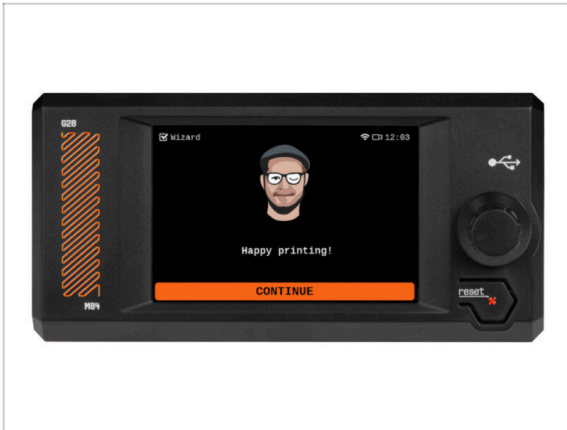

- ◆ Congratulations! The Wizard is complete. Now it's time to test some prints.

## STEP 14 Setting the printer up



- ◆ To enable automatic opening of the top grille, go to **Settings** -> **Hardware** -> **Chamber Vent Control** and set to **Auto**.

---

## STEP 15 Haribo time

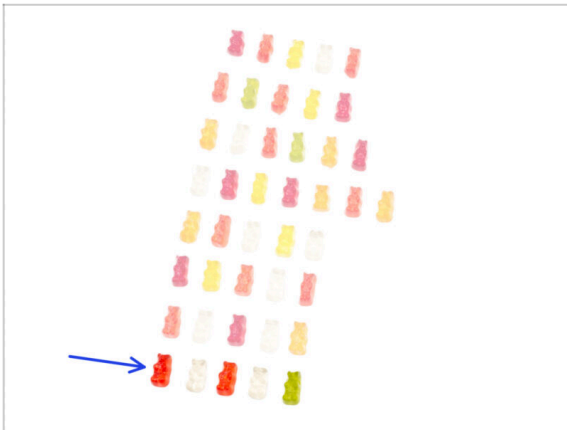

- Victory tastes like gummy bears!
- Enjoy the rest. You've earned this.

---

## STEP 16 Handbook



- Read the **3D Printing Handbook** dedicated to your printer and follow the instructions to set up the printer and prepare it for your first print.
- 📌 The latest version is always available at [help.prusa3d.com](https://help.prusa3d.com).
- ⚠️ **Read the Disclaimer and Safety instructions chapters.**

## STEP 17 Firmware update

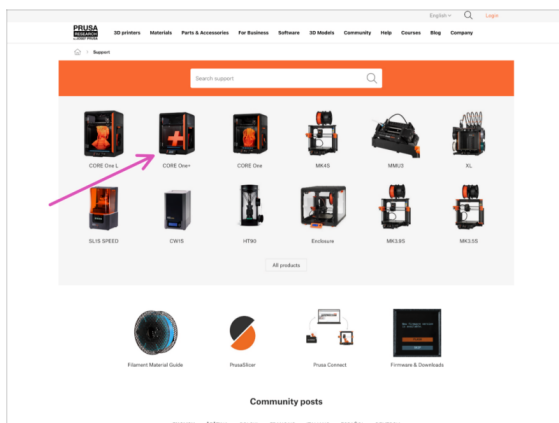

- i All printers come with a USB drive containing the latest firmware. However, it is recommended to check and possibly upgrade the firmware version every few weeks.
- ◆ Visit the [help.prusa3d.com](https://help.prusa3d.com) page.
- ◆ Navigate to the Prusa CORE One+ page.
- ◆ Save the firmware file (*.bbf*) onto the *bundled USB drive*.
- ◆ Plug the USB drive into the printer. Then, when prompted, select the **FLASH** option on the display.

## STEP 18 Give us feedback



- ◆ We know you're eager to start printing, but we'd really appreciate it if you could take 3–4 minutes to **share your thoughts** on this manual: how clear it was, how easy it was to follow, and any ideas to improve it.
- i This feedback is a little different from the usual comments you might leave on individual steps.
- ◆ **Share your feedback here.**
- ◆ Thank you for helping us make our manuals even better!



# Manual changelog



## STEP 1 Version history



- **Versions of the Prusa CORE One+ conversion kit manual:**
- 11/2025 - Initial version 1.00
- 03/2026 - Updated to version 1.01
- 05/2026 - Updated to version 1.02

## STEP 2 Changes to the manual (1)

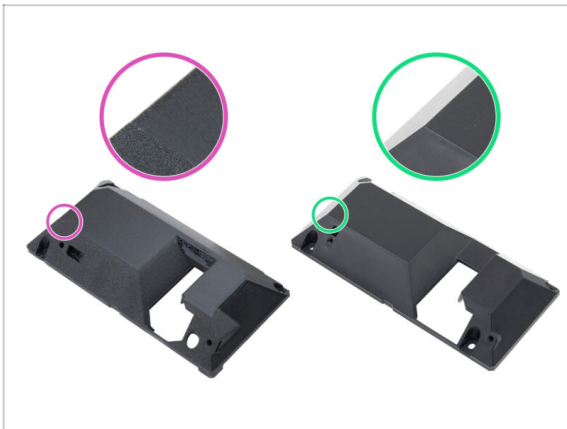

- 03/2026 - new xLCD display mount
- Added instructions for the new injection-molded xLCD display mount.
- ⓘ Manual version 1.01

### STEP 3 Changes to the manual (2)

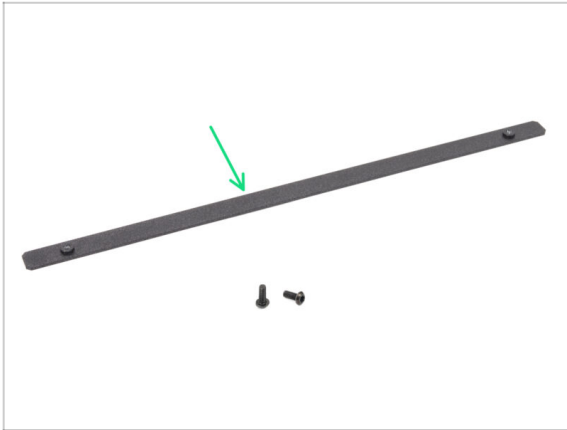

- 05/2026 - Door handle installation.
- Added separate instructions for screw-mounted and glued door handle installation. Conditional flow added to guide users to the correct procedure based on supplied parts.
- ⓘ Manual version 1.02









