

# Table of Contents

<b>1. Introduction</b>	3
Step 1 - General information	4
Step 2 - What awaits you during the unpacking	4
Step 3 - Tools in the package	5
Step 4 - Labels guide	5
Step 5 - Cheatsheet	6
Step 6 - Silicone sock	6
Step 7 - CAUTION: Lubricant Handling	7
Step 8 - View high resolution images	7
Step 9 - We are here for you!	8
Step 10 - Unpacking the printer	8
<b>2A. Printer Unboxing</b>	9
Step 1 - Introduction	10
Step 2 - Opening the package	10
Step 3 - Opening the package	11
Step 4 - Removing the fixations	11
Step 5 - Removing the fixations	12
Step 6 - Unpacking the printer	12
Step 7 - Hooray! The printer is ready for the set up	12
<b>2B. Printer Unboxing</b>	13
Step 1 - Introduction	14
Step 2 - Opening the package	14
Step 3 - Opening the package	15
Step 4 - Removing the inserts	15
Step 5 - Removing the inserts	16
Step 6 - Removing the inserts	16
Step 7 - Unpacking the printer	17
Step 8 - Printer is ready for setup	17
<b>3. Printer set up</b>	18
Step 1 - Tools necessary for this chapter	19
Step 2 - Nextruder cable bundle assembly info	19
Step 3 - Variant B - Nextruder cable bundle assembly parts preparation	20
Step 4 - Variant B - Nextruder cable bundle assembly	20
Step 5 - Variant B - Nextruder cable bundle assembly	21
Step 6 - Variant B - Nextruder cable bundle assembly	21
Step 7 - Preparing the printer	22
Step 8 - Installing the extruder: parts preparation	22
Step 9 - Installing the extruder	23
Step 10 - Securing the extruder	23
Step 11 - Guiding the extruder cable	24
Step 12 - Attaching the extruder cable	25
Step 13 - Guiding the extruder PTFE tube	25
Step 14 - Wi-Fi antenna holder versions	26
Step 15 - Version A: Connecting the extruder cable	26
Step 16 - Version A: Installing the Wi-Fi antenna: parts preparation	27
Step 17 - Version A: Installing the Wi-Fi antenna	27
Step 18 - Version B: Wi-Fi antenna holder: parts preparation	28
Step 19 - Version B: Installing the Wi-Fi antenna: antenna preparing	28
Step 20 - Version B: Installing the Wi-Fi antenna: antenna preparing	29
Step 21 - Version B: Connecting the extruder cable	29

Step 22 - Version B: Installing the Wi-Fi antenna holder .....	30
Step 23 - Version B: XL buddy box covering .....	30
Step 24 - Version B: Installing the Wi-Fi antenna: parts preparation .....	31
Step 25 - Version B: Installing the Wi-Fi antenna .....	31
Step 26 - Spoolholder assembly versions .....	32
Step 27 - Version A: Assembling the spool holder: parts preparation .....	32
Step 28 - Version A: Assembling the spool holder: adjusting the nut .....	33
Step 29 - Version A: Assembling the spool holder .....	33
Step 30 - Version A: Mounting the spool holder assembly .....	34
Step 31 - Version B: Assembling the spool holder: parts preparation .....	34
Step 32 - Version B: Assembling the spool holder: adjusting the nut .....	35
Step 33 - Version B: Assembling the spool holder .....	35
Step 34 - Version B: Preparing the spool holder .....	36
Step 35 - Version B: Mounting the spool holder assembly .....	36
Step 36 - Injection molded xLCD: parts preparation .....	37
Step 37 - Injection molded xLCD: xLCD cables .....	37
Step 38 - Injection molded xLCD: mounting the xLCD .....	38
Step 39 - Older xLCD assembly versions .....	38
Step 40 - Version A: Mounting the xLCD: parts preparation .....	39
Step 41 - Version A: xLCD cables .....	39
Step 42 - Version B: Mounting the xLCD: Parts preparation .....	40
Step 43 - Version B: xLCD cables .....	40
Step 44 - Version C: mounting the xLCD .....	41
Step 45 - Mounting the xLCD .....	41
Step 46 - Almost done! .....	42
<b>4. First run .....</b>	<b>43</b>
Step 1 - Before you start with Single-Tool .....	44
Step 2 - Preparing the printer .....	44
Step 3 - Prusa Nextruder sock (Optional) .....	45
Step 4 - Wizard .....	45
Step 5 - Wizard - Test Loadcell .....	46
Step 6 - Wizard - Calibrate Filament Sensors .....	46
Step 7 - Wizard - Calibrate Filament Sensors .....	47
Step 8 - It's done .....	47
Step 9 - Quick guide for your first prints .....	48
Step 10 - Printable 3D models .....	48
Step 11 - Prusa knowledge base .....	49
Step 12 - Join Printables! .....	49
<b>Manual changelog .....</b>	<b>50</b>
Step 1 - Version history .....	51
Step 2 - Changes to the manual (1) .....	51
Step 3 - Changes to the manual (3) .....	52
Step 4 - Changes to the manual (2) .....	52
Step 5 - Changes to the manual (4) .....	53
Step 6 - Changes to the manual (5) .....	53

# 1. Introduction



## STEP 1 General information

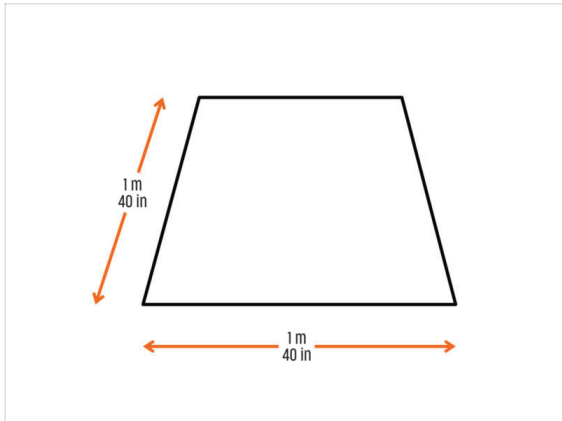
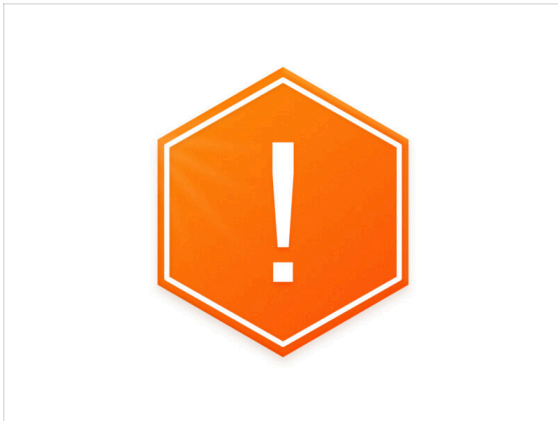

**⚠ The package with the printer is heavy!** Always ask another person for help with handling.

- For the assembly, **prepare a clean workbench with a space of at least 1 m x 1 m (40 in x 40 in).**
- We're recommending a **bright light above your workbench.** Some parts of the printer are dark and inadequate light could make a very difficult procedure.

## STEP 2 What awaits you during the unpacking

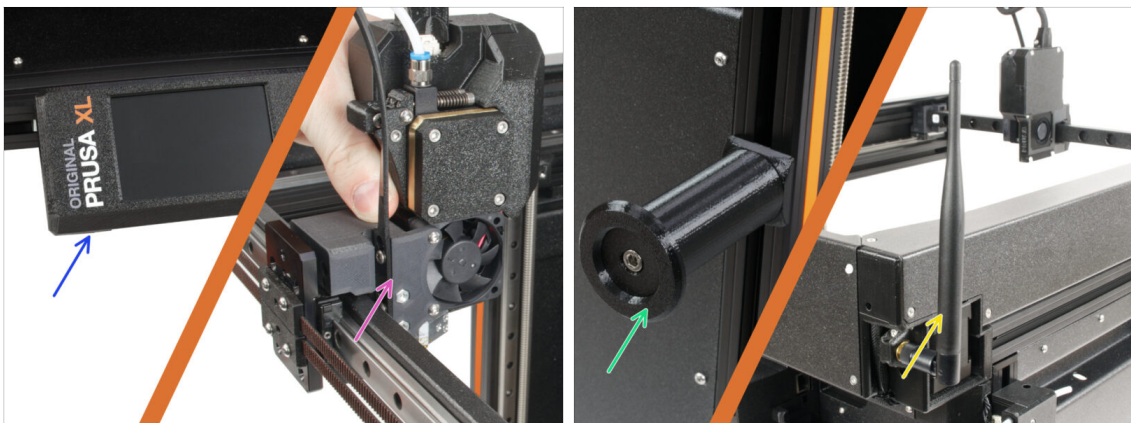

**i** Because of transportation, some of the fragile parts must be safely packed separately in the printer package. This manual will take you through the installation of these parts on the printer.

- **These parts will be installed:**
  - LCD assembly
  - Single tool extruder assembly
  - Spool holder
  - Wi-Fi antenna

## STEP 3 Tools in the package



### ◆ The package includes:

ⓘ Some of the tools are intended primarily for regular printer maintenance. You won't need them for this manual. At the beginning of the assembly chapter is a list of the necessary tools.

- ◆ Torx key TX6, TX8, TX10
- ◆ Allen key 2.5 mm, 4.0 mm
- ◆ Wrench 13-16
- ◆ Universal wrench
- ◆ Philips PH2 screwdriver

◆ **The printer's package contains a lubricant, which is intended for maintenance.** No need to apply it during the assembly. There is a dedicated online manual [Regular printer maintenance](#).

## STEP 4 Labels guide

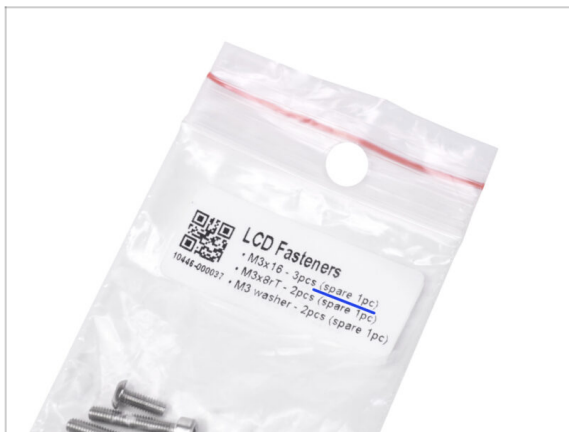

- ◆ All the boxes and bags including parts for the build are labeled.
- ◆ The LCD Fasteners bag includes an extra spare of each part contained in the bag. The amount of spare parts is written on the label. This number is included in the total number of each type of part.

## STEP 5 Cheatsheet

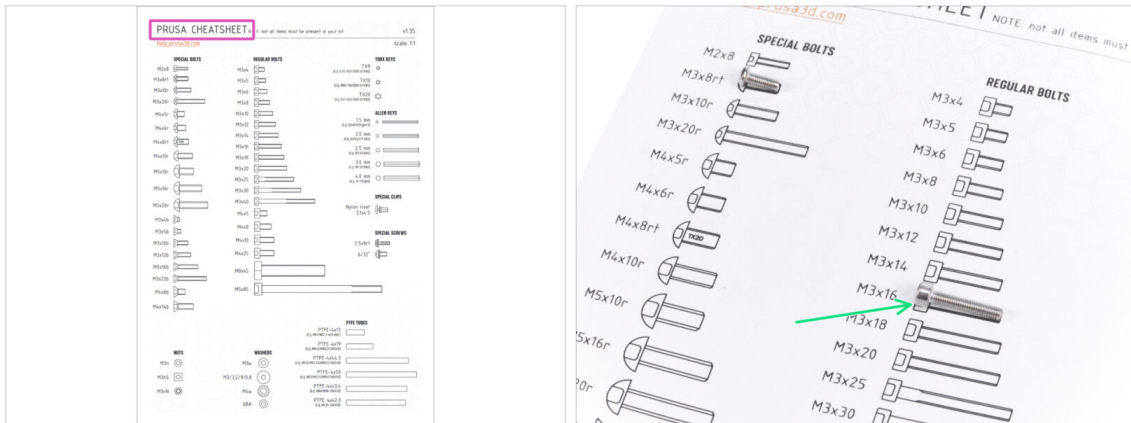

- ◆ Your package contains a letter, on the back of which is a Cheatsheet with drawings of all the necessary fasteners.
- ◆ The fasteners drawings are 1:1 scale, so you can compare the size by placing the fastener on the paper to make sure you are using the correct type.
- ⓘ You can download it from our site [help.prusa3d.com/cheatsheet](https://help.prusa3d.com/cheatsheet). Print it at 100 %, don't rescale it, otherwise, it won't work.

## STEP 6 Silicone sock



- ◆ A silicone sock is supplied with each Nextruder package.
- ◆ The main function of a silicone sock is to keep the temperature in the heater block stable, which improves the printer's performance.
- ⓘ Also, it keeps your hotend clean from filament dirt and protects it in case the print detaches from the print surface.
- ◆ You will be asked to install the sock later in this guide.
- ⓘ How to install the sock - [check the article](#).

## STEP 7 CAUTION: Lubricant Handling

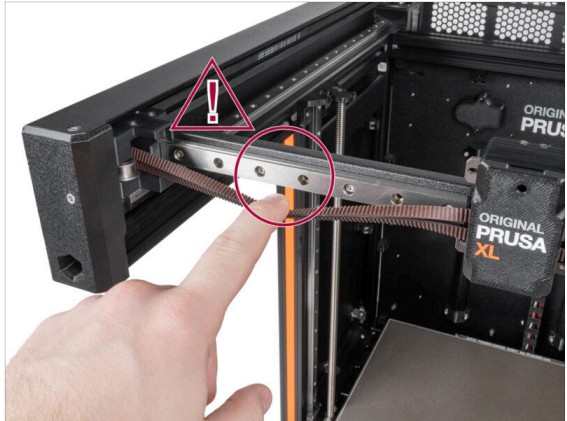
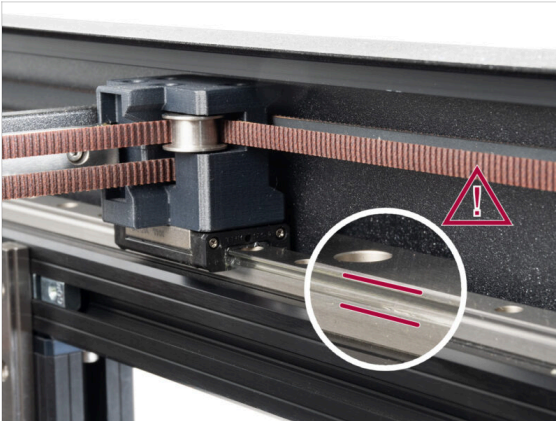

**⚠ CAUTION: Avoid direct skin contact with the lubricant used for the linear rails in this printer. If a contact occurs, wash your hands immediately. Especially before eating, drinking, or touching your face.**

- Lubricant accumulates in the printer's bearings, mainly in the linear rail channels.

## STEP 8 View high resolution images



**i** When you browse the guide on [help.prusa3d.com](https://help.prusa3d.com), you can view the original images in high resolution for clarity.

- ◆ Just hover your cursor over the image and click the Magnifier button ("View original") in the top left corner.

## STEP 9 We are here for you!

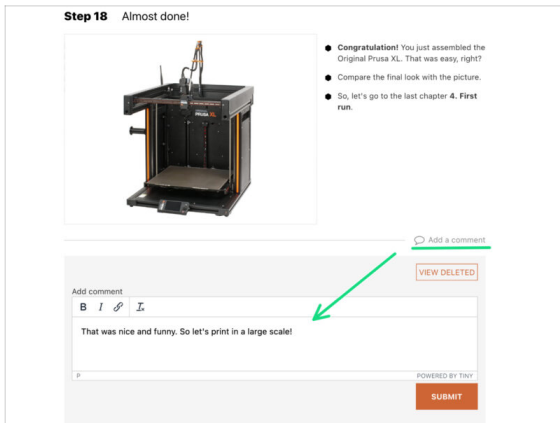
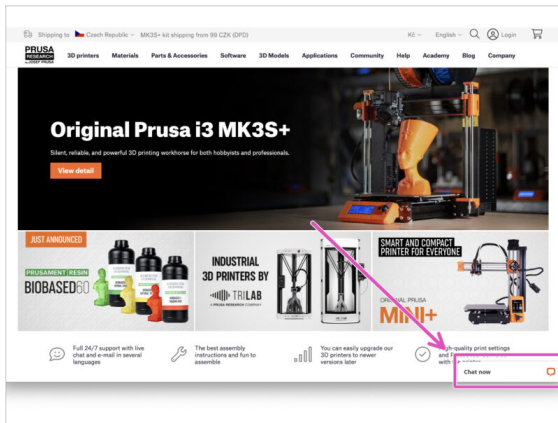

- Lost in the instructions? Missing screw or cracked printed part? **Let us know!**
- You can contact us using following channels:
  - Using comments under each step.
  - Using our 24/7 live chat at [shop.prusa3d.com](https://shop.prusa3d.com)
  - Writing an email to [info@prusa3d.com](mailto:info@prusa3d.com)

## STEP 10 Unpacking the printer



- There are two versions of the printer package. The first units shipped have the **Package A**. The later batches were shipped in the **Package B**.
  - ⓘ The printer itself inside the box is the same. Only the packaging and the unboxing process differs.
- **Package version A** has adhesive labels on the box. If you have this version, continue to the chapter **2A. Printer Unboxing**.
- **Package version B**. This version can be easily distinguished by having the image of a printer on the box. If you have this version, continue to the chapter **2B. Printer Unboxing**.





## 2A. Printer Unboxing







## STEP 1 Introduction



-  **The package with the printer is heavy!** Always ask the other person for help with handling.
-  **If children are involved, always supervise them to avoid injury.**
-  **We recommend keeping all the packaging material** in case you decide to send the printer for service.

## STEP 2 Opening the package



-  Place the package on a stable place. **Make sure the package is oriented top side up.** See the transportation label.
-  The box is equipped with two easy-to-tear zippers. They separate the box into two parts.
-  Find the zippers on the edge of both long sides of the package.
-  Gently pull the head of the zipper.

### STEP 3 Opening the package



- ❗ The zips are designed to build on each other, **no matter which one you start with.**
- 🔴 Tear zippers on both sides to fully separate the box. One zipper opens two sides, the longer and the shorter side.
- 🟠 Now, the top part is separated from the bottom part.
- 🟡 Slide the top part to separate the box upwards by the handles.
- ❗ In the upper part, the cardboard fixings may stuck.

### STEP 4 Removing the fixations



- ⚠️ There are cardboard fixings that contain the parts necessary for the assembly. **Do not throw them out!**
- 🟠 Take off the front top fixation with the parts inside and put it on the safe place. We will need these parts later on.

## STEP 5 Removing the fixations

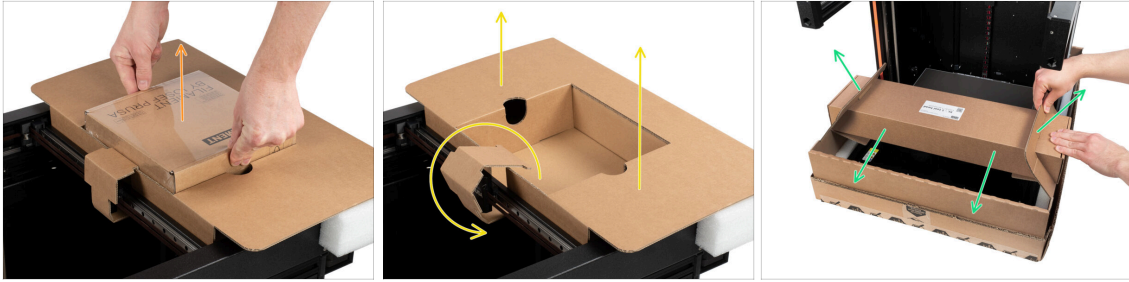

**⚠** The cardboard fixings contain the parts necessary for the assembly. **Do not throw them out!**

- 🟠 Take out included Prusament.
- 🟡 The fixation is unlocked, remove the rear top fixation from the printer.
- 🟢 Pull up the cardboard to unlock the bottom box from the main lower box part and take it off.

## STEP 6 Unpacking the printer

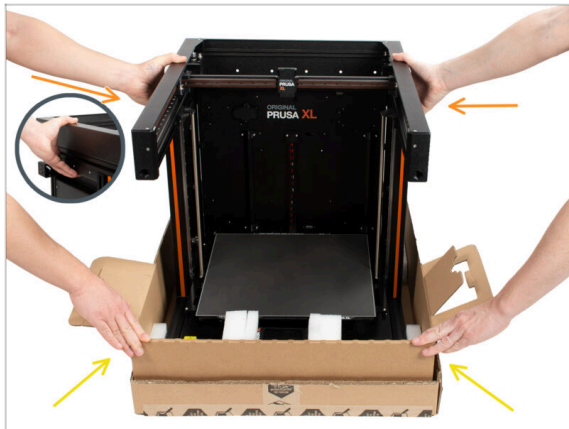

- 🟠 Use the side handles on both sides of the printer to handle.
- ⚠** **Do not hold the printer by the top metal profiles!!!** Otherwise, you may warp the printer and damage the LED lighting inside the profiles.
- ⚠** Handle the printer in two persons.
- 🟡 Hold the bottom box and pull out the printer. Place it in a designated area.

## STEP 7 Hooray! The printer is ready for the set up





- 🟠 Good job! You just unpacked all the parts necessary for the printer set up.
- 🟠 Now, go to chapter **3. Printer set up**.

## 2B. Printer Unboxing







## STEP 1 Introduction

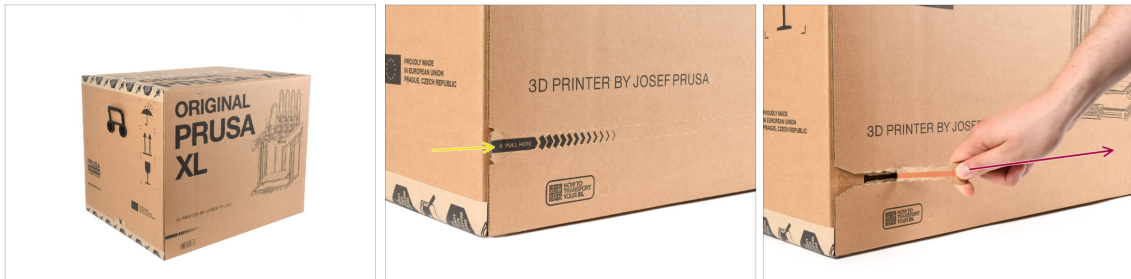

-  **The printer package is heavy!** Ask someone to help you out.
-  **If children are involved, always supervise them to avoid an injury.**
-  **We recommend keeping all the packaging material** in case you decide to send the printer back for service.

## STEP 2 Opening the package



-  Place the package on a stable surface. **Make sure the package is oriented top side up.** See the transportation label.
-  The package is equipped with a tear strip that splits the box in two parts.
-  Peel off the entire tear strip to split the box.

### STEP 3 Opening the package



Remove the top part of the box by lifting it up.

⚠ Inside, there are cardboard inserts that contain parts necessary for the assembly. **Do not throw them out!**

### STEP 4 Removing the inserts



Remove the top front cardboard insert.

Remove the box on the side containing the extruder parts.

Remove the cardboard insert with the Haribos inside.

## STEP 5 Removing the inserts



- Remove the front inner insert.
- Remove the box with Prusament on top.

## STEP 6 Removing the inserts



- There is a lever inside the top cardboard insert that locks it to the printer's frame. Pull the lever to unhook the insert.
- While pulling the lever, lift the whole insert and remove it.
- ⚠ There are printer parts inside the top cardboard insert! Make sure not to lose them!**



## STEP 7 Unpacking the printer



- Use the side handles on the printer to lift it up.
- ⚠ Do not handle the printer by the top metal profiles!!! Otherwise, you may warp the printer parts and damage the parts such as the LED lighting inside.
- ⚠ Handle the printer in two people by the sides.
- Hold the bottom of the box while you lift the printer up.

## STEP 8 Printer is ready for setup



- Good job! The printer is ready for the next step:
- Visit chapter 3. **Printer set up.**

### 3. Printer set up



## STEP 1 Tools necessary for this chapter

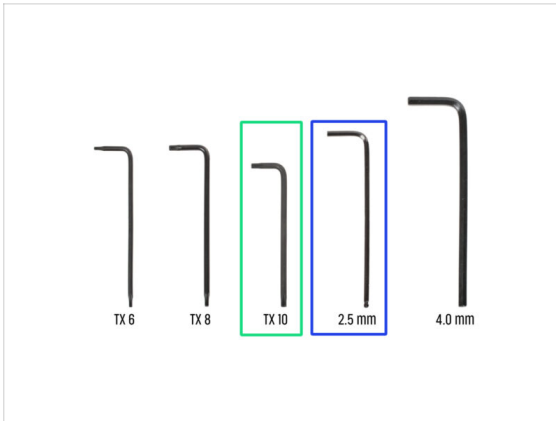

● For this chapter, please prepare:

● TX 10 Torx key

● 2.5mm Allen key

● A cardboard box to be used as a heatbed protection during the set up. *Hint: you can use the Prusament box shipped with your printer.*

## STEP 2 Nextruder cable bundle assembly info



⚠ Take a look at the nextruder, there are two variants:

● **Variant A:** the cable bundle is attached to the nextruder already. Please skip to **Step 7 - Preparing the printer.**

● **Variant B:** the cable bundle is disconnected from the nextruder and must be first attached first. Continue to the next step.

### STEP 3 Variant B - Nextruder cable bundle assembly parts preparation



● For the following steps, please prepare:

- Nextruder cable bundle (1x)
- Nextruder (1x)
- This is the end of the nextruder cable bundle we are going to attach to the Nextruder in the next step. It consists of a cable connector, a flexible plate and a semi-transparent PTFE tube.

### STEP 4 Variant B - Nextruder cable bundle assembly

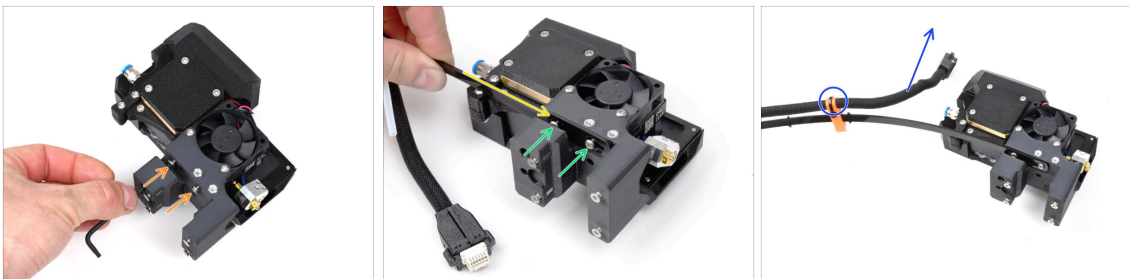

- Using the T10 key, loosen the marked two screws on the inside of the nextruder.
- Hook up the keyhole openings in the flexible plate of the cable bundle onto the screw heads.
- Make sure the part of the bundle with the cable and the connector is facing the top of the extruder; as seen in the picture.
- ⚠ The cable bundle must be installed exactly the same way as in the picture; with the cable on top and the semi-transparent PTFE tube on the bottom.

## STEP 5 Variant B - Nextruder cable bundle assembly

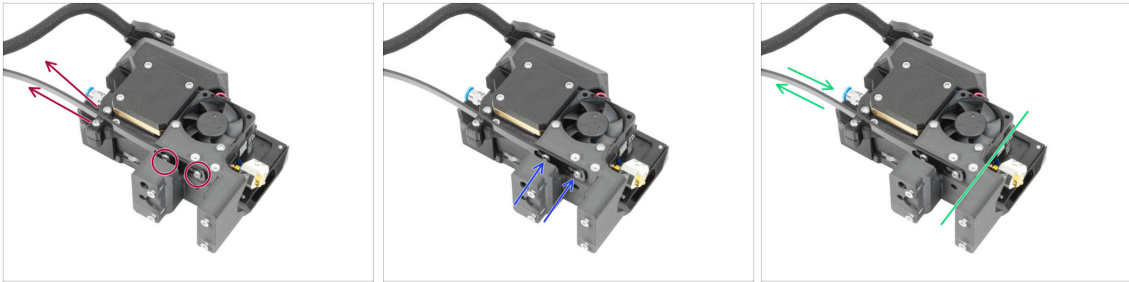

- ◆ Pull the flexible line up so that the screws engage into the narrower part of the keyhole openings.
- ⚠ Verify both screws have engaged.
- ◆ While the screws sit in the narrower parts of the openings, tighten them up using the T10 key.
- ◆ Verify the flexible part of the cable bundle is held tight to the extruder body.

## STEP 6 Variant B - Nextruder cable bundle assembly

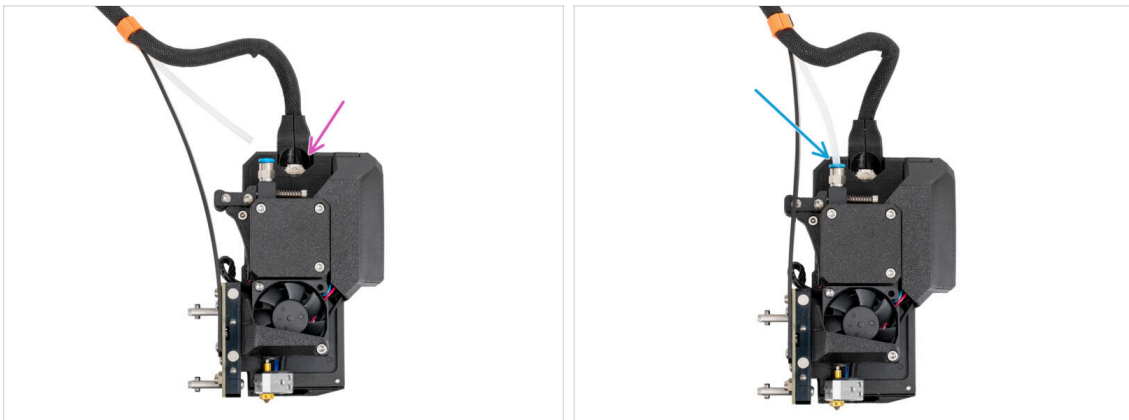

- ◆ Attach the cable connector into the top of the nextruder.
- ◆ Insert the semi-transparent PTFE tube into the FESTO fitting on the nextruder. Push it all the way in.
- ⓘ Starting from September 2024, you may receive a new black Fitting M5-4. The assembly and functionality remain identical to the blue one.
- ◆ Good! Your nextruder is prepared for the next step.

## STEP 7 Preparing the printer



- ⚠ From now on, the **setup is the same** both for **Variant A** and **Variant B**.
- ⚠ **Reminder: To handle the printer, always grab the handles on both sides of the printer.** Do not lift the printer by the aluminum extrusions or the metal sheet profiles on top.
- ⓘ In the following steps, we will work with tools and install extruder above the heatbed, it is recommended to protect it against any possible damage. An empty Prusament box can serve this purpose.
  - 🔵 Place the empty cardboard box approximately to the front center part of the heatbed.
  - 🟢 Move the X-axis assembly all the way to the front side of the printer.
  - 🟡 Move the X-carriage approximately to the center of the X-axis.

## STEP 8 Installing the extruder: parts preparation

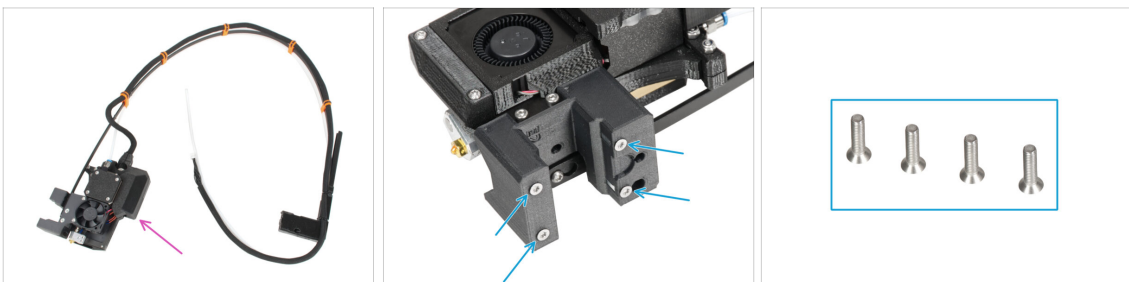

- 🔸 **For the following steps, please prepare:**
  - 🟡 Single tool extruder assembly (1x)
    - ⓘ Due to the careful testing of each printer before it is shipped, there may be a small filament residue on the extruder nozzle.
  - 🔵 From the extruder body, remove 4x M3x12b (countersunk) screws and set them aside. You will need them in the next step.

## STEP 9 Installing the extruder

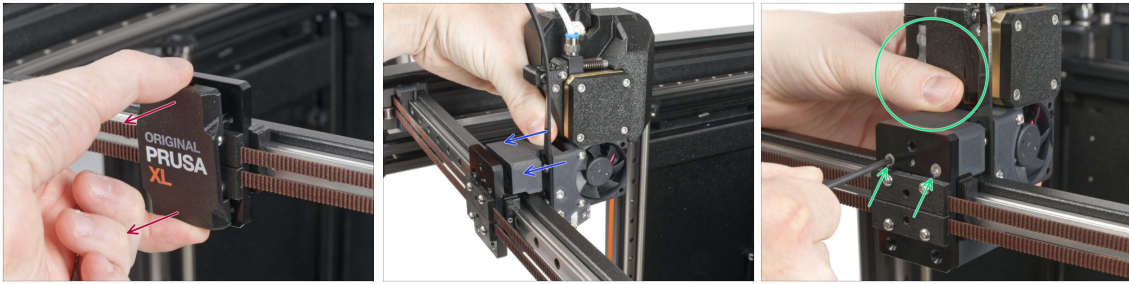

- Remove the x-carriage-cover from the X-carriage.
- From the back of the X-carriage, attach the extruder assembly to the X-carriage. See the correct orientation of the extruder.
- Hold the extruder and secure it by inserting and tightening two M3x12b screws into the top screw holes. **Do not fully tighten the screws at the moment!**

## STEP 10 Securing the extruder

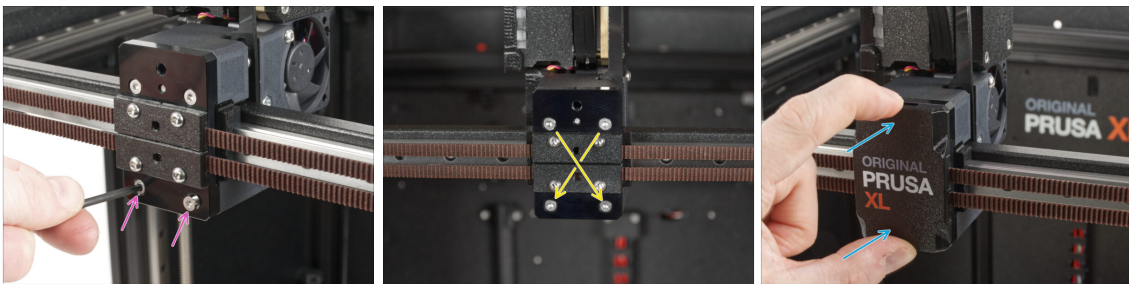

- Insert and tighten two M3x12b screws to the lower holes in the X-carriage to secure the extruder assembly. **Do not fully tighten the screws at the moment!**
  - Fully tighten all four screws **diagonally** to secure the extruder assembly.
  - Snap the x-carriage-cover back onto the X-carriage. You must feel a slight "click" to ensure the cover fits on the part.
-  **Remove the Prusament cardboard box from the heatbed.**

## STEP 11 Guiding the extruder cable

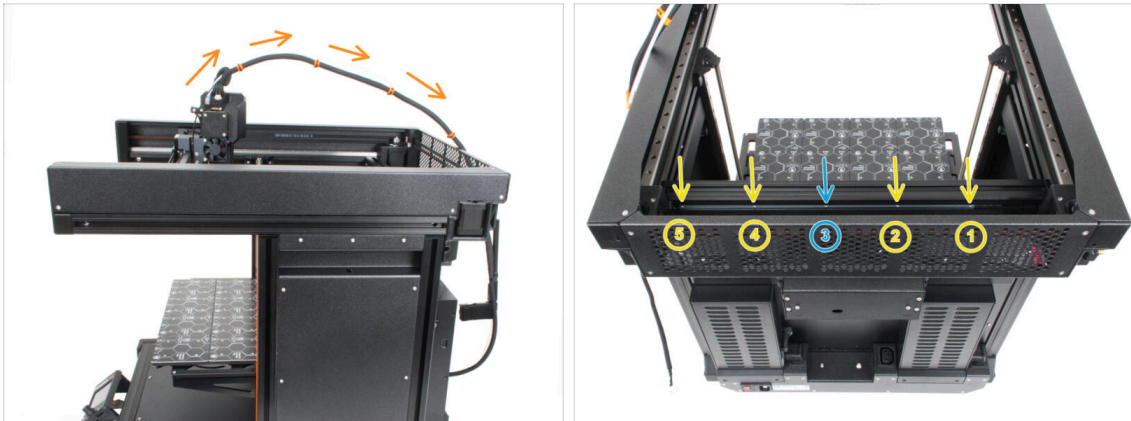

- Guide the extruder cable bundle with the PTFE tube freely over the printer to its rear side.
- Turn the printer around so that the PSU side is facing you.
- Locate the long metal profile (tch-mounting-insert) in the back of the top extrusion. It has five threaded openings in it.
- There is a screw in the long metal profile which is fixing the part during the transport. Using the Allen key, remove the screw from the profile. Keep it as a spare.

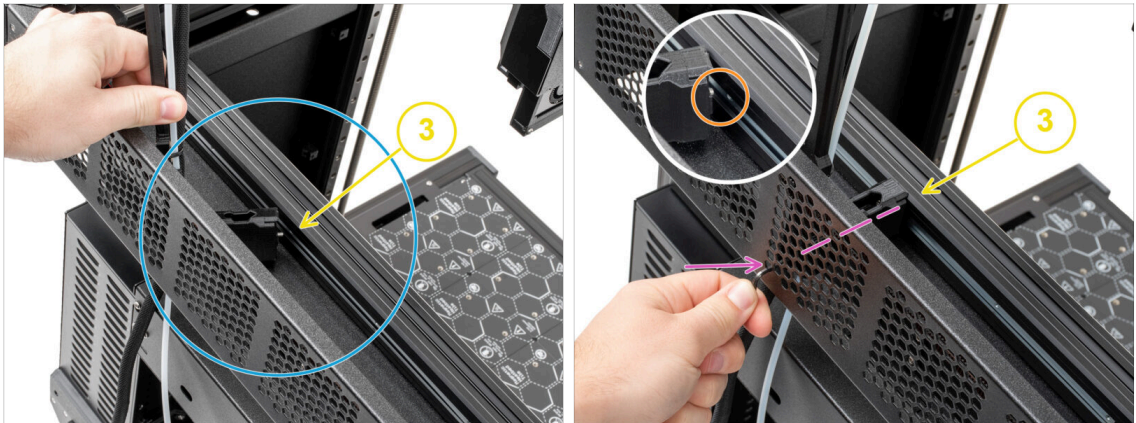

**STEP 12** Attaching the extruder cable

- Locate the long metal profile (tch-mounting-insert) in the back of the top extrusion. It has five threaded openings in it.
  - Place the xl-dock-cable-router on the bottom metal sheet below the aluminum extrusion.
  - There is a screw protruding from the xl-dock-cable-router. The screw must be attached to the **third threaded opening** on the long metal profile. Look through the rear metal sheet to check if the cable holder is lined up with the correct opening.
  - Push the 2.5 mm Allen key all the way through a hole (bottom left in the pattern) in the rear metal sheet as well as through the plastic part until you reach the screw. Tighten it up.
- i** The dock is a press fit, so the screw needs to be tightened very hard.

**STEP 13** Guiding the extruder PTFE tube

- There is a side filament sensor on the side of the printer. Insert the free extruder PTFE tube all the way into the upper hole in the part.
- Gently pull the PTFE tube back, this will push out the black collet in the side filament sensor and lock the tube.

## STEP 14 Wi-Fi antenna holder versions

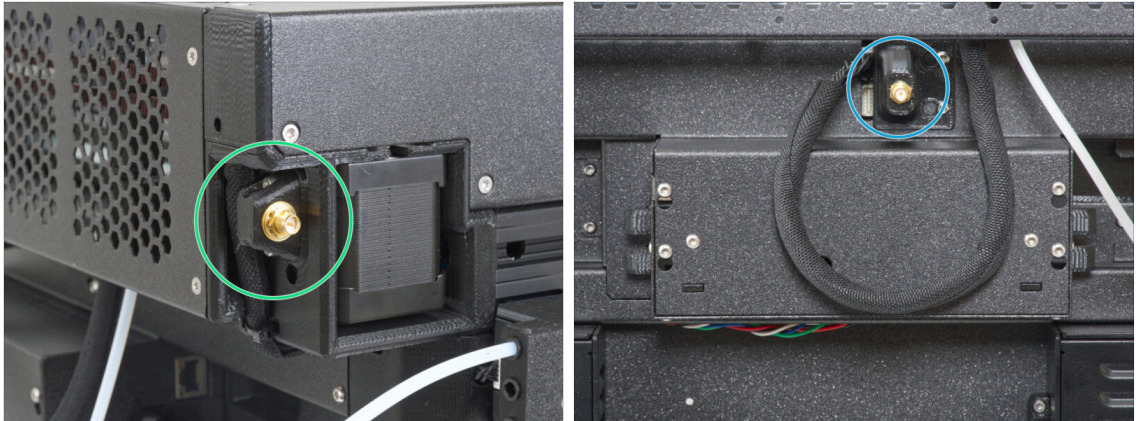

- The antenna connector is prepared by the manufacturer:
  - Version A: The Wi-Fi antenna holder is on the side. **Continue to the next step.**
- The antenna connector has to be assembled by you:
  - Version B: The Wi-Fi antenna holder is in the middle. Please skip to **Version B: Connecting the extruder cable.**

## STEP 15 Version A: Connecting the extruder cable

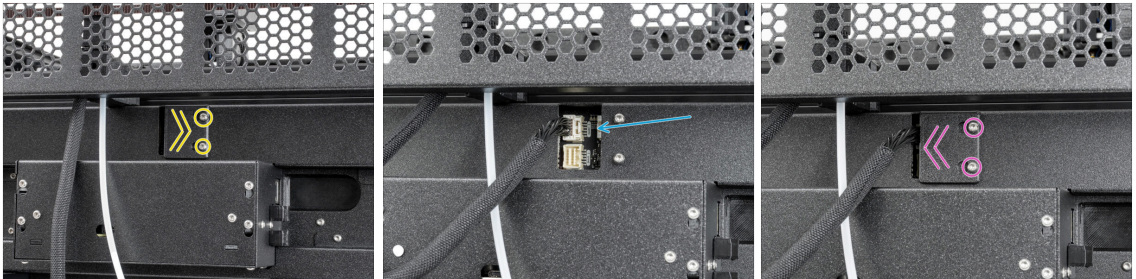

- Locate the xl-rear-cable-management-plug (cover) on the rear of the printer.
- Loosen two screws on the cover slightly. No need to remove them completely. Push the cover to the right and remove it from the printer.
- Connect the extruder cable to the upper slot labeled DWARF 1.
- Attach the connectors cover to the screws. Push it all the way to the right and tighten the screws.

## STEP 16 Version A: Installing the Wi-Fi antenna: parts preparation



- For the following steps, please prepare:
- Wi-Fi antenna (1x)
- ⓘ The Original Prusa XL is shipped with two versions of the Wi-Fi antenna, each with a different shape. The functionality is the same.

## STEP 17 Version A: Installing the Wi-Fi antenna

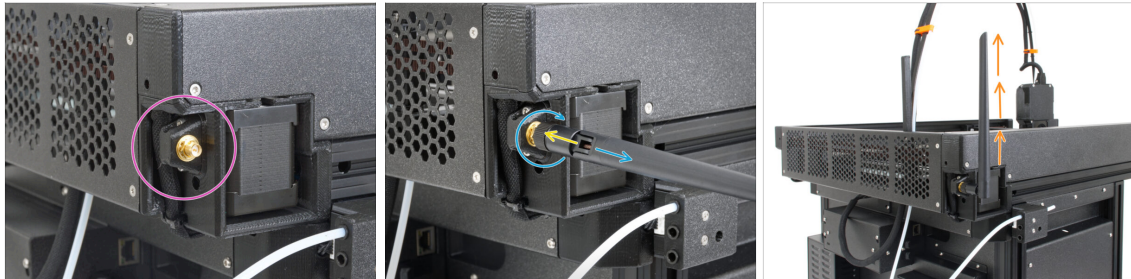

- Locate the Wi-Fi antenna connector on the right rear corner of the printer.
- The antenna can be rotated around and bent in two directions.
- We recommend pointing the antenna straight upwards.
- Now skip to [Step 26 - Assembling the spool holder: parts preparation](#)

## STEP 18 Version B: Wi-Fi antenna holder: parts preparation

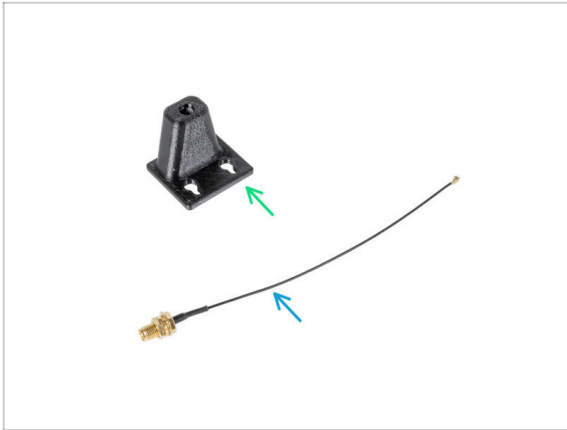

● For the following steps, please prepare:

- Wi-Fi-antenna-holder version E3/E4 (1x)
- Antenna cable (1x)

## STEP 19 Version B: Installing the Wi-Fi antenna: antenna preparing

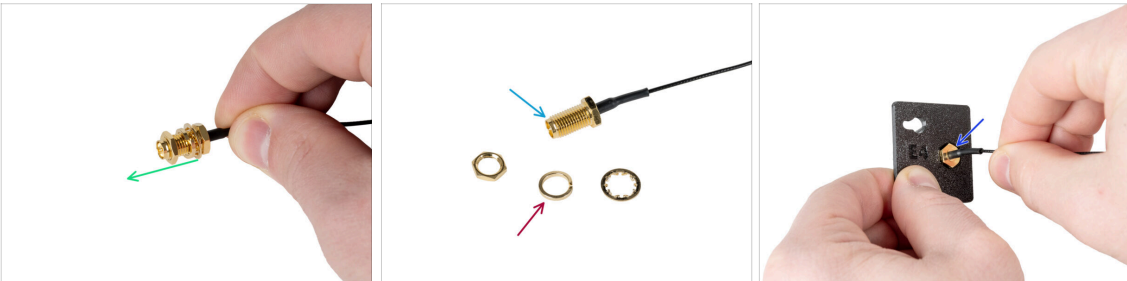

- Remove the nut with the washers from the antenna connector.
- The antenna connector is prepared.
- The latest version of the connector has a thicker washer. We don't need it anymore. You can throw it away.
- Insert the antenna connector into the same-shaped hole in the Wi-Fi-antenna-holder .

## STEP 20 Version B: Installing the Wi-Fi antenna: antenna preparing

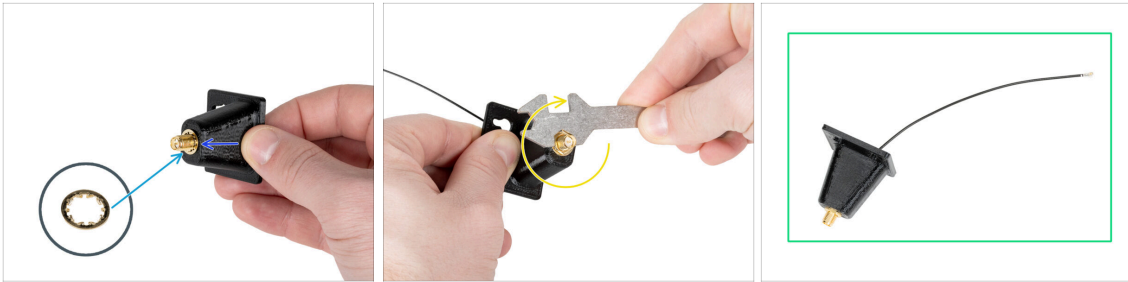

- ◆ Push the antenna connector through the Wi-Fi-antenna-holder.
- ◆ Insert the thinner washer back onto the connector.
- ◆ Using the universal wrench, tighten the nut on an antenna connector.
- ◆ Good job! The Wi-Fi antenna is prepared.

## STEP 21 Version B: Connecting the extruder cable

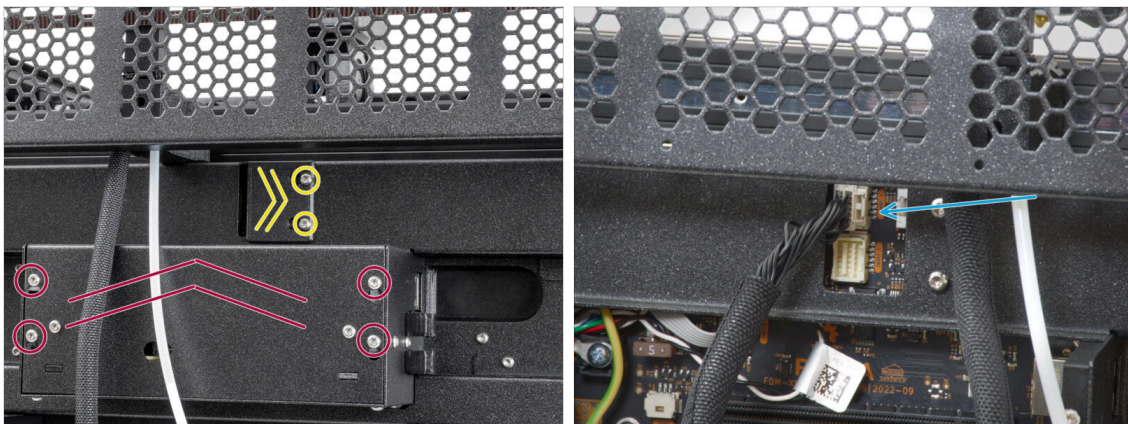

- ◆ Locate the xl-rear-cable-management-plug (cover) on the rear of the printer.
- ◆ Loosen two screws on the cover slightly. No need to remove them completely. Push the cover to the right and remove it from the printer.
- ◆ Loosen four screws securing the electronics cover. Remove the cover.
- ◆ Connect the first dock (from the right side) cable to the upper slot labeled DWARF 1.

## STEP 22 Version B: Installing the Wi-Fi antenna holder

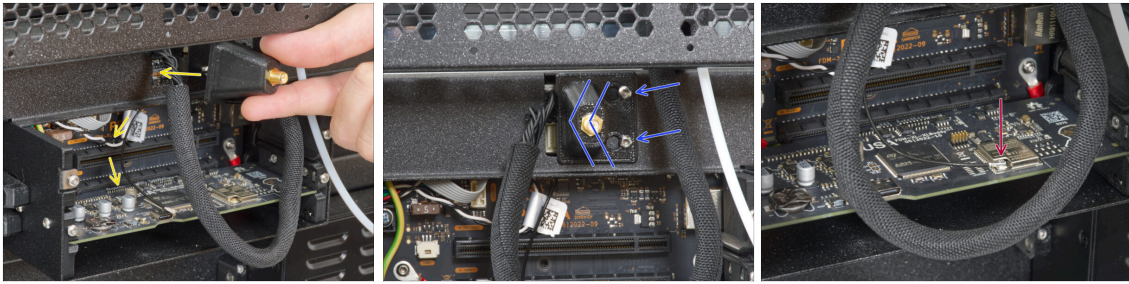

- ✦ Push the antenna cable through the opening in the cable cover (metal sheet) and guide it behind the cover to the electronics box.
- ✦ Attach the antenna-holder on the screws and push the cover to the left. Tighten the screws.
- ✦ Connect the antenna to the appropriate slot on the XL Buddy board.

## STEP 23 Version B: XL buddy box covering

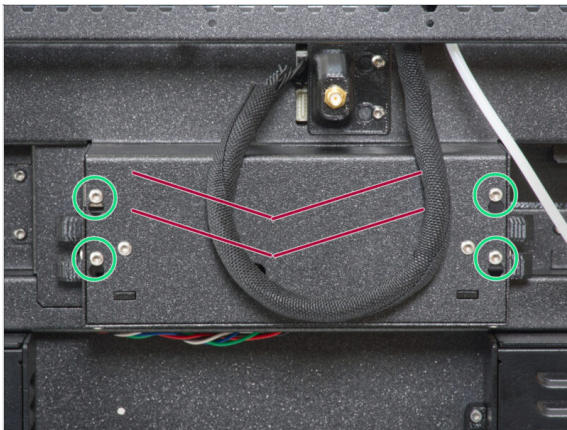

- ⚠ Be careful, do not pinch any cables!
- ✦ Put the XL-buddy-box-cover back on the printer.
- ✦ With a T10 key tighten the four screws.

## STEP 24 Version B: Installing the Wi-Fi antenna: parts preparation



◆ For the following steps, please prepare:

◆ Wi-Fi antenna (1x)

ⓘ The Original Prusa XL is shipped with two versions of the Wi-Fi antenna, each with a different shape. The functionality is the same.

## STEP 25 Version B: Installing the Wi-Fi antenna



- ◆ Locate the Wi-Fi antenna connector in the middle of the printer.
- ◆ Screw the Wi-Fi antenna on the antenna connector. The antenna can be rotated around and bent in two directions.
- ◆ We recommend pointing the antenna straight upwards.

## STEP 26 Spoolholder assembly versions

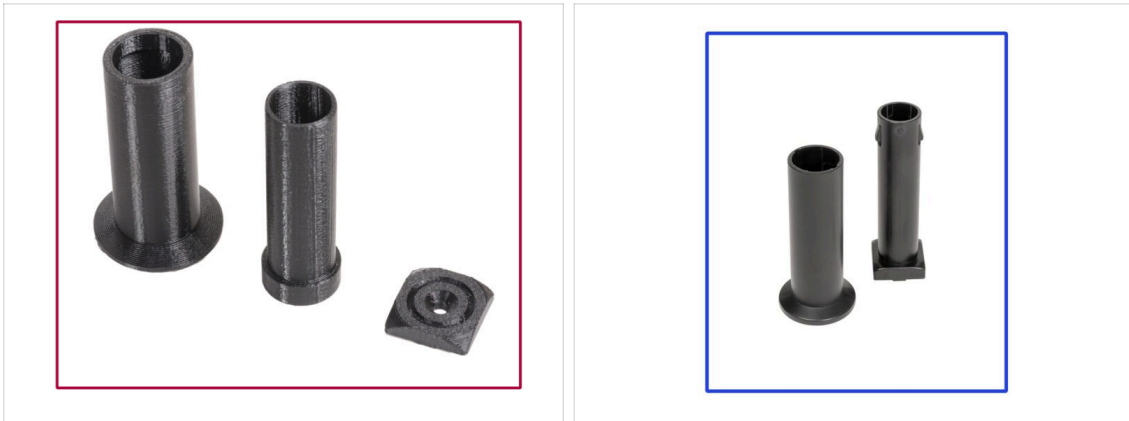

- i** Original Prusa XL comes with two versions of the spool holder. Each version has slightly different parts and different procedures.
- ◆** Refer to the pictures to compare which parts you have, and then choose the instructions that match:

    - ◆** **Printed spool holder (Version A):** Set of three printed parts. If you have this version, continue to the **Version A: Assembling the spool holder: parts preparation**
    - ◆** **Injection molded spool holder (Version B):** Set of two injection molded parts. If you have this version, continue to **Version B: Assembling the spool holder: parts preparation**

## STEP 27 Version A: Assembling the spool holder: parts preparation

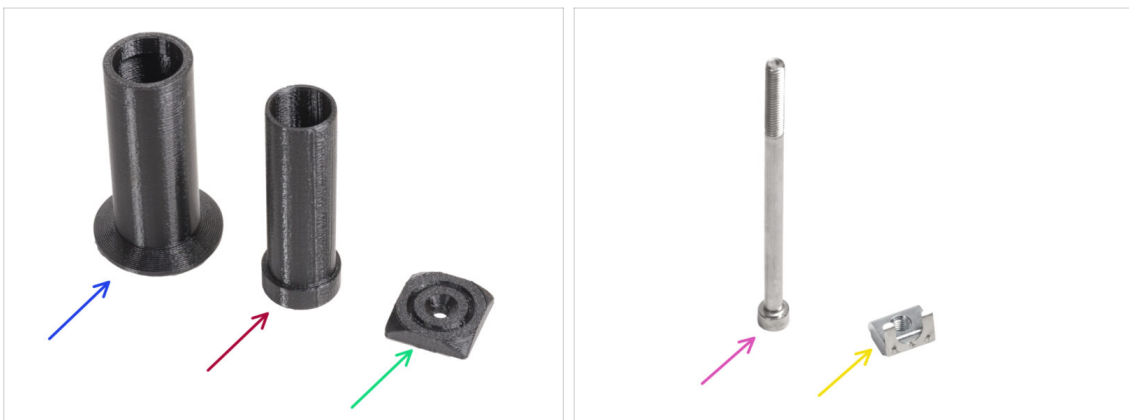

- ◆** For the following steps, please prepare:
- ◆** Spool-holder-slider (1x)
  - ◆** Spool-holder-base (1x)
  - ◆** Spool-holder-mount (1x)
  - ◆** M5x85 screw (1x)
  - ◆** M5nEs nut (1x)



**STEP 28** Version A: Assembling the spool holder: adjusting the nut

- Carefully turn the printer so that the side with the Wi-Fi antenna and side filament sensor faces you.
- Insert the M5nEs nut into the front support extrusion (with the orange plastic cover). Insert the side with the spring (metal plate) first, then push the nut inside.
- The M5nEs nut is free to move, you can adjust the position as you want. But remember, the nut must be slightly pushed in to smoothly move. Anyway, we recommend approximately the same position as you can see in the picture.

**STEP 29** Version A: Assembling the spool holder

- Insert the spool-holder-base into the spool-holder-slider and push it through a little through the part.
- Attach the spool-holder to the spool-holder-mount.
- Insert the M5x85 screw into the spool-holder-assembly.

### STEP 30 Version A: Mounting the spool holder assembly



- Attach the spool holder assembly to the M5nEs nut in the extrusion. Note that there is a protrusion on the spool-holder-mount, which must fit into the groove in the extrusion.
- Tighten the spool holder assembly.
- ⚠ Do not use the spool holder as a handle!**

### STEP 31 Version B: Assembling the spool holder: parts preparation



- For the following steps, please prepare:
- Spool-holder-slider (1x)
- Spool-holder-base (1x)
- M4x12 screw (1x)
- M4nEs nut (1x)

### STEP 32 Version B: Assembling the spool holder: adjusting the nut



- Carefully turn the printer so that the side with the side filament sensor is facing you.
- Insert the M4nEs nut into the front support extrusion (with the orange plastic cover). Insert the side with the spring (metal plate) first, then push the nut inside.
- The M4nEs nut is free to move, you can adjust the position as you want. But remember, the nut must be slightly pushed in to smoothly move. Anyway, we recommend approximately the same position as you can see in the picture.

### STEP 33 Version B: Assembling the spool holder

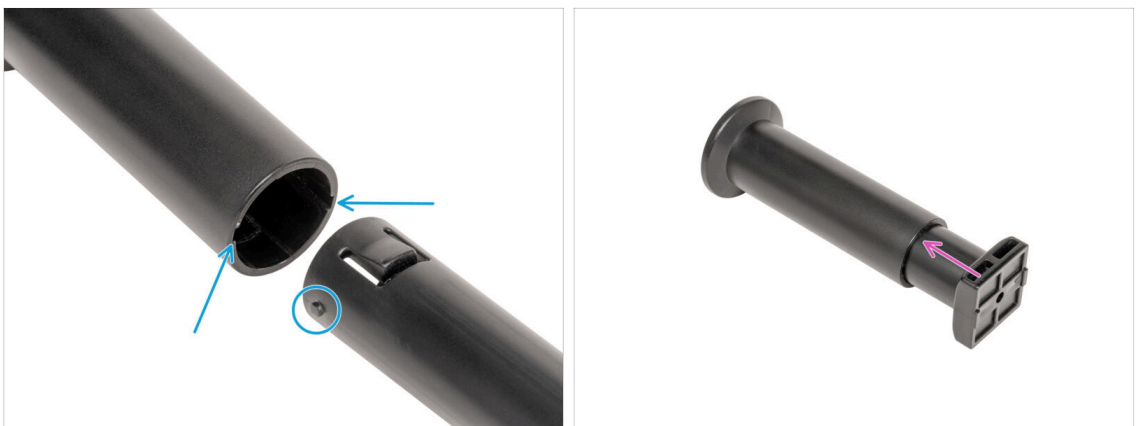

- Locate pins two pins on the spool-holder-base and line them with the rails in the spool-holder-slider.
- Insert the spool-holder-base into the spool-holder-slider and push it through a little through the part.

### STEP 34 Version B: Preparing the spool holder



- ✦ Insert the M4x12 screw on the longer side of the 3mm Allen key.
- ✦ Insert the 3mm Allen key with the M4x12 screw through the assembled spool holder to the prepared hole in the spool-holder-base.
- ✦ The M4x12 screw has to protrude through the spool-holder-base.

### STEP 35 Version B: Mounting the spool holder assembly



- ✦ Attach the spool holder assembly to the M4nEs nut in the extrusion. Note that there is a protrusion on the spool-holder-mount, which must fit into the groove in the extrusion.
  - ✦ Tighten the spool holder assembly.
- ⚠ Do not use the spool holder as a handle!**

## STEP 36 Injection molded xLCD: parts preparation

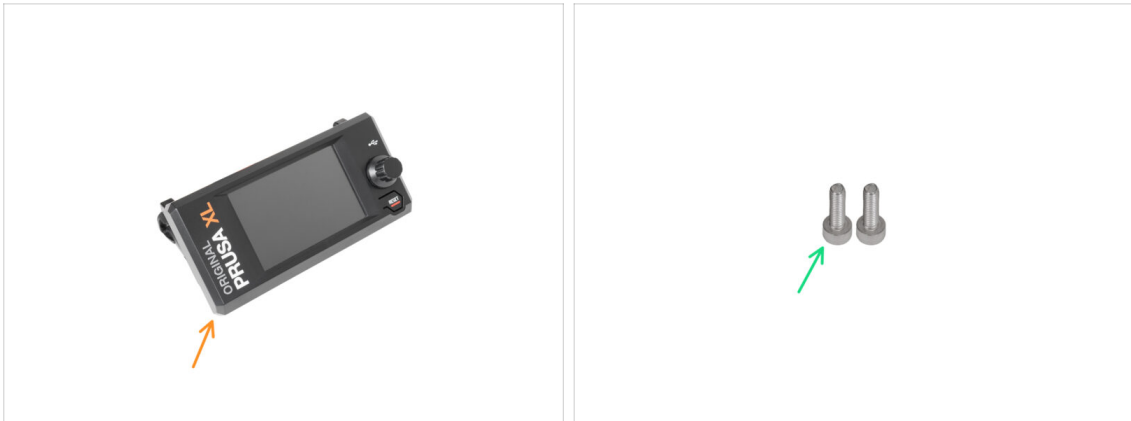

**i** Starting from September 2024, you may receive a new injection molded xLCD.

**◆** For the following steps, please prepare:

**◆** xLCD assembly (1x)

**◆** M3x10 screw (2x)

**◆** If you have an older version (printed) xLCD, continue to the step **Older xLCD assembly versions**

## STEP 37 Injection molded xLCD: xLCD cables

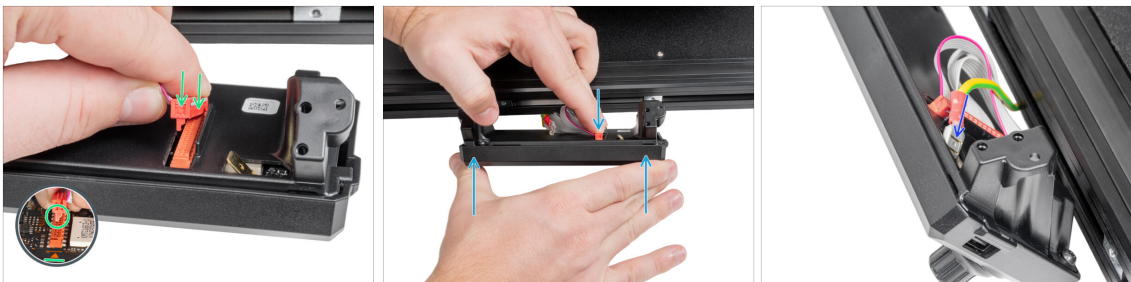

**◆** Connect the xLCD cable to the slot on the xLCD board.

**i** There is a latch on the xLCD cable connector, which must be facing the triangle symbol on the board. See the picture.

**◆** Push the xLCD cable connector to fully connect to the xLCD. Hold the xLCD cover.

**◆** Push the earthing connector fully into the PE faston.

### STEP 38 Injection molded xLCD: mounting the xLCD



- ◆ Align the xLCD assembly with the nuts in the front aluminum extrusion.
- ◆ Insert and tighten the M3x10 screw from the left side of the xLCD.
- ◆ Insert and tighten the M3x10 screw from the left side of the xLCD.
- ◆ xLCD is ready.

### STEP 39 Older xLCD assembly versions

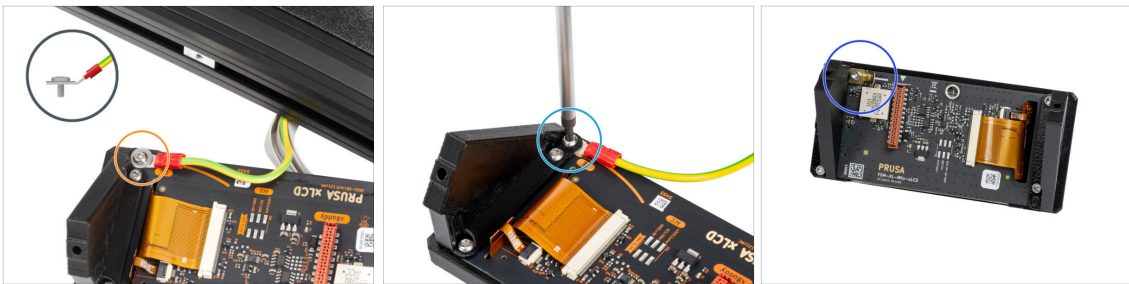

- ⚠ Take a look at the xLCD, there are three variants:
- ◆ Version A: with an M3 washer under the screw
  - ◆ Version B: without the washer under the screw
  - ◆ Version C: faston on the top left

## STEP 40 Version A: Mounting the xLCD: parts preparation



● For the following steps, please prepare:

- xLCD assembly (1x)
- M3x16 screw (2x)
- M3x8rT (1x)
- M3 washer (1x)

## STEP 41 Version A: xLCD cables

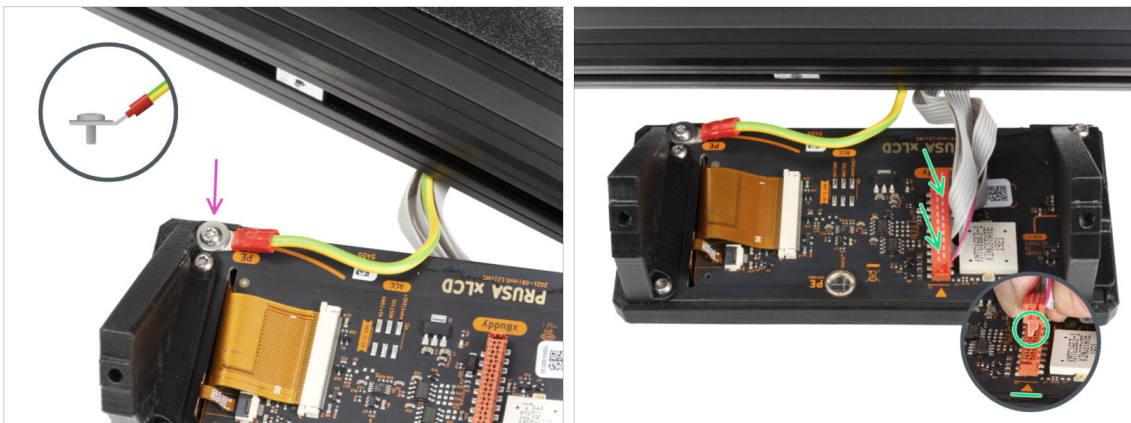

- Carefully turn the printer so that the front side is facing you.
- From the front of the printer, place the xLCD assembly close to the lower front aluminum extrusion where are the xLCD cables.
- Using the M3x8rT screw and the M3 washer, connect the PE cable to the PE hole on the xLCD board. See the detail showing the correct position of the cable connector.
- Connect the xLCD cable to the slot on the xLCD board.
- **i** There is a latch on the xLCD cable connector, which must be facing the triangle symbol on the board. See the detail.

## STEP 42 Version B: Mounting the xLCD: Parts preparation



◆ For the following steps, please prepare:

- ◆ xLCD assembly (1x)
- ◆ M3x8rT (1x)

## STEP 43 Version B: xLCD cables

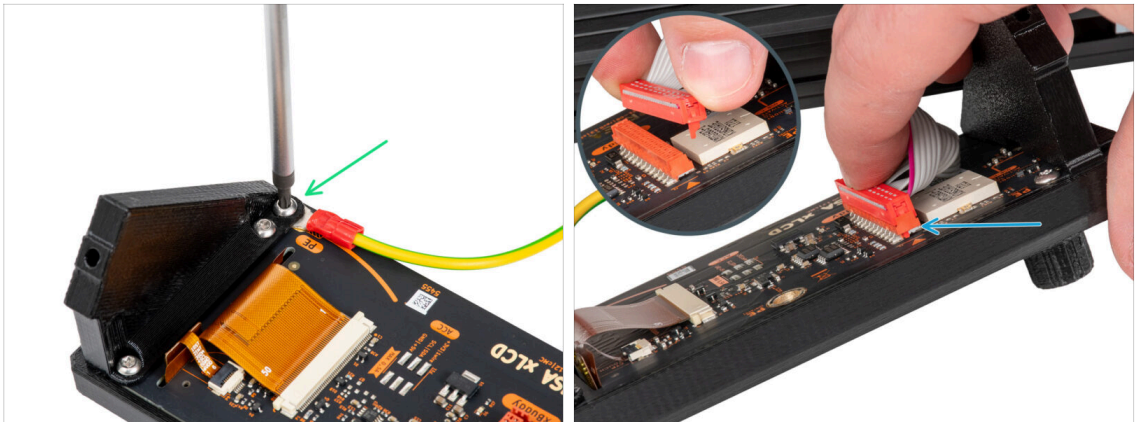

- ◆ Carefully turn the printer so that the front side is facing you.
- ◆ From the front of the printer, place the xLCD assembly close to the lower front aluminum extrusion where are the xLCD cables.
- ◆ Using the M3x8rT screw, connect the PE cable to the PE hole on the xLCD board.
- ◆ Connect the xLCD cable to the slot on the xLCD board.
- ⓘ There is a latch on the xLCD cable connector, which must be facing the triangle symbol on the board. See the detail.



## STEP 44 Version C: mounting the xLCD

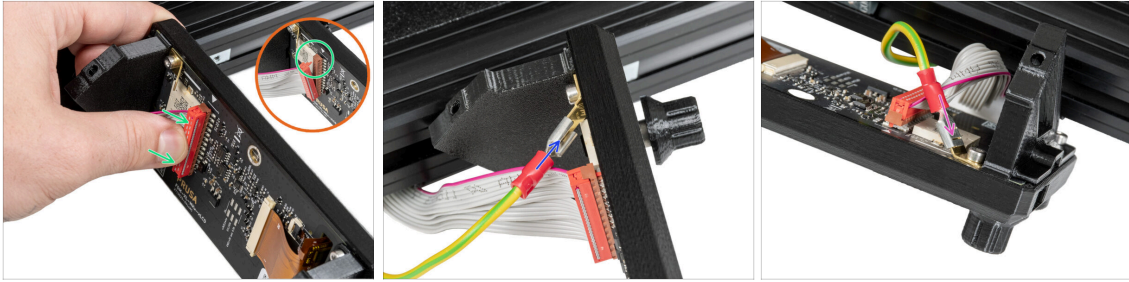

- Carefully turn the printer so that the front side is facing you.
- From the front of the printer, place the xLCD assembly close to the lower front aluminum extrusion where are the xLCD cables.
- Connect the xLCD cable to the slot on the xLCD board.
  - ⓘ There is a latch on the xLCD cable connector, which must be facing the triangle symbol on the board. See the detail.
- Connect the earthing cable and connect it to the PE connector on the xLCD.
- Push the earthing connector fully into the PE faston.

## STEP 45 Mounting the xLCD

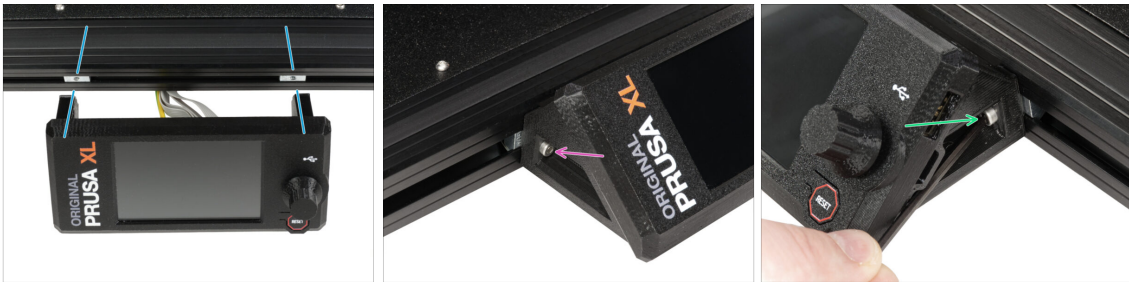

- Align the xLCD assembly with the nuts in the front aluminum extrusion.
- Insert and tighten the M3x16 screw from the left side of the xLCD.
- Insert and tighten the M3x16 screw from the right side of the xLCD.

## STEP 46 Almost done!



- ◆ **Congratulation!** Your Original Prusa XL is ready to be fired up!
- ◆ Compare the final look with the picture.
- ◆ Now, let's go to the last chapter **4. First run.**

## 4. First run



## STEP 1 Before you start with Single-Tool

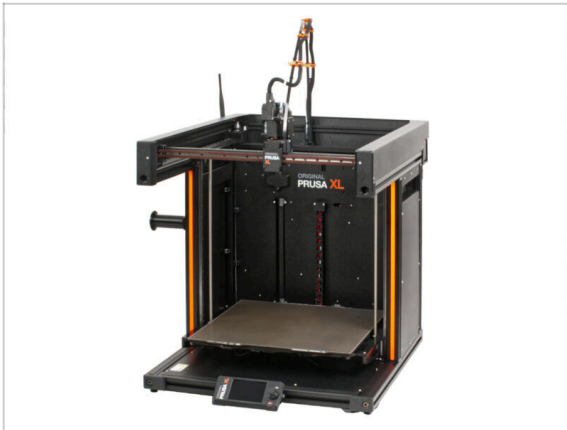

- i** This chapter shows a brief description of the wizard. Please note that the screenshots are illustrative and might differ from those in the firmware.
- i** Make sure you are running **Firmware 5.1.2 or newer**

## STEP 2 Preparing the printer



- !** Make sure that the printer is placed in a stable place where no ambient vibrations are transmitted (for example, where other printers are printing).
- ◆** From the rear side of the printer, plug in the PSU cable.
- ◆** Turn the power switch ON (symbol "I").

### STEP 3 Prusa Nextruder sock (Optional)



- ◆ A silicone sock is supplied with each Nextruder package.
- ◆ If you want to install the sock, **do it before the calibration.**
- ⓘ How to install the sock - [check the article.](#)

### STEP 4 Wizard



- ◆ After the printer starts up, the screen prompts for the printer test and setup wizard.
- ⓘ Although we inspect and test every printer before shipping, it is recommended to repeat the process once the printer is assembled.
- ◆ Using the knob, click on **CONTINUE**.
- ⓘ The wizard will test all important components of the printer. The whole process takes a few minutes. Some parts of the wizard require direct user interaction. Follow the instruction on the screen.
- ⚠ **NOTE: While testing the axes, make sure that there is nothing in the printer that is obstructing the movement of the axes.**
- ⚠ **WARNING: Do not touch the printer during the wizard unless prompted! Some parts of the printer may be HOT and moving at high speed.**
- ◆ The wizard starts with the fan check, Z-axis alignment and the test of the XY axes, which is fully automatic.

## STEP 5 Wizard - Test Loadcell

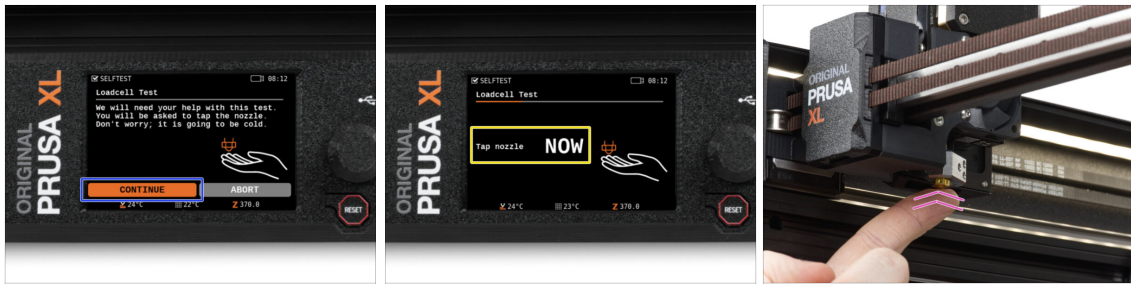

- ◆ The next step of the wizard will prompt you to touch the nozzle to test and calibrate the **Loadcell**. During this procedure, the parts of the printer are not heated, you can touch the parts of the printer. Click on **Continue**.
- ◆ Do not touch the nozzle yet, wait until prompted with the message: **Tap the nozzle NOW**.
- ◆ Slightly tap the nozzle. No need to use extra force. In case the Loadcell does not detect enough touch, you will be prompted to repeat the step. Otherwise, you will see **Loadcell test passed OK** when it succeeds.

## STEP 6 Wizard - Calibrate Filament Sensors



- ◆ During the calibration of the filament sensors, you will be prompted to use at least 130 cm of filament. *Hint: Use the Prusament shipped with your printer and hang it directly on the spool holder.*
- ◆ When you have prepared the filament, click on **YES**.
- ◆ Do not insert the filament into the side filament sensor and the tool head. If the side filament sensor is empty, click on **CONTINUE**.

## STEP 7 Wizard - Calibrate Filament Sensors

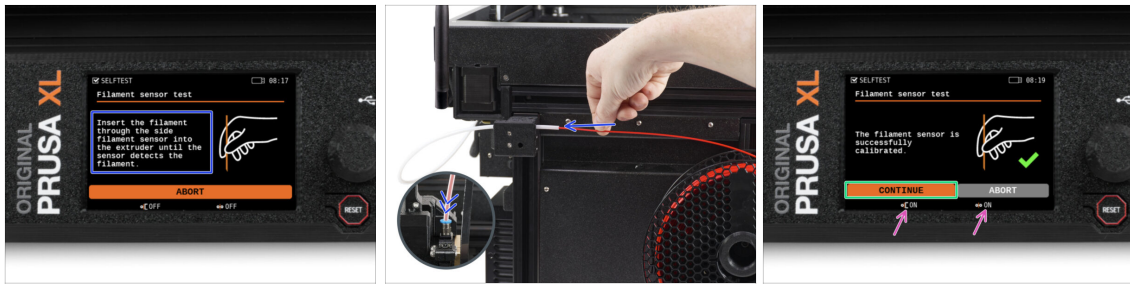

- ◆ Now, insert the filament into the side filament sensor and push it until it reaches the filament sensor in the extruder (you will feel a slight resistance).
- ◆ You can check the side filament sensor (left) and extruder filament sensor (right) status on the bottom bar on the screen.
- ◆ Both filament sensors are successfully calibrated and tested. Click on **CONTINUE**.

## STEP 8 It's done



- ◆ Manually remove the filament from the printer. And click on **CONTINUE**.
- ◆ **That's all, the printer is ready to print.** But still, follow the instructions in this manual to the end.

## STEP 9 Quick guide for your first prints



Now, please read the **3D Printing Handbook**, which is tailor-made for your printer and **follow the instructions to set up the printer properly**. The latest version is always available at [this link](#).



**Read the chapters *Disclaimer* and *Safety instructions*.**

## STEP 10 Printable 3D models

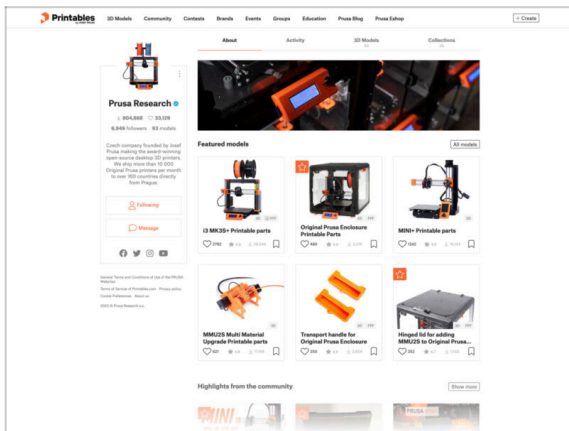

**Congratulations! You should be ready to print by now ;-)**



You can start by printing some of our test objects bundled on the included USB stick - you can check them out [in this collection](#).



## STEP 11 Prusa knowledge base

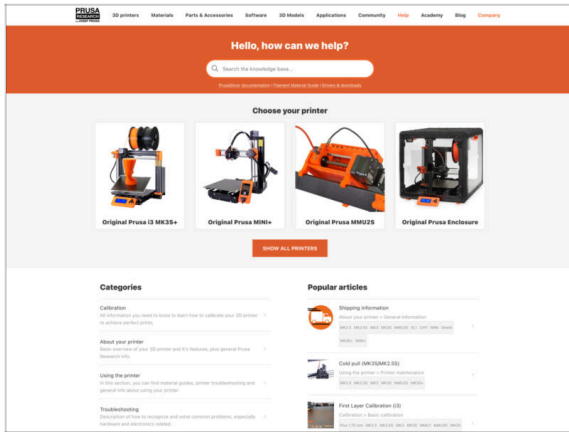

- If you encounter any problems at all, don't forget you can always check out our knowledge base at [help.prusa3d.com](https://help.prusa3d.com)
- We're adding new topics every day!

## STEP 12 Join Printables!

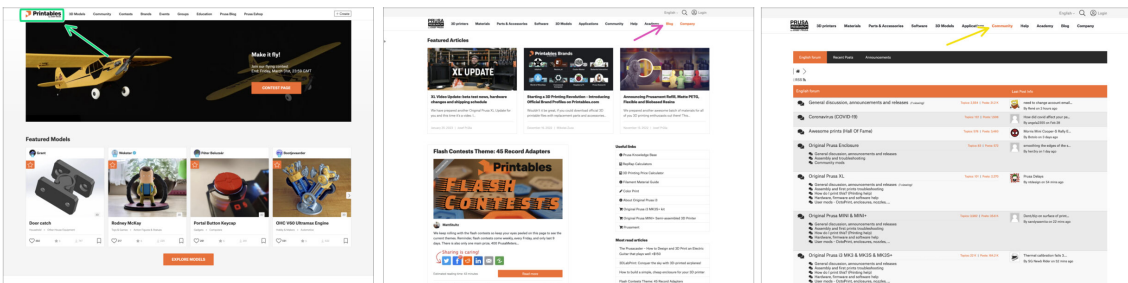

- Don't forget to join the biggest Prusa community! Download the latest models in STL or G-code tailored for your printer. Register at [Printables.com](https://printables.com)
- Looking for inspiration on new projects? Check our blog for weekly updates.
- If you need help with the build, check out our forum with a great community :-)
- All services share one account.

# Manual changelog

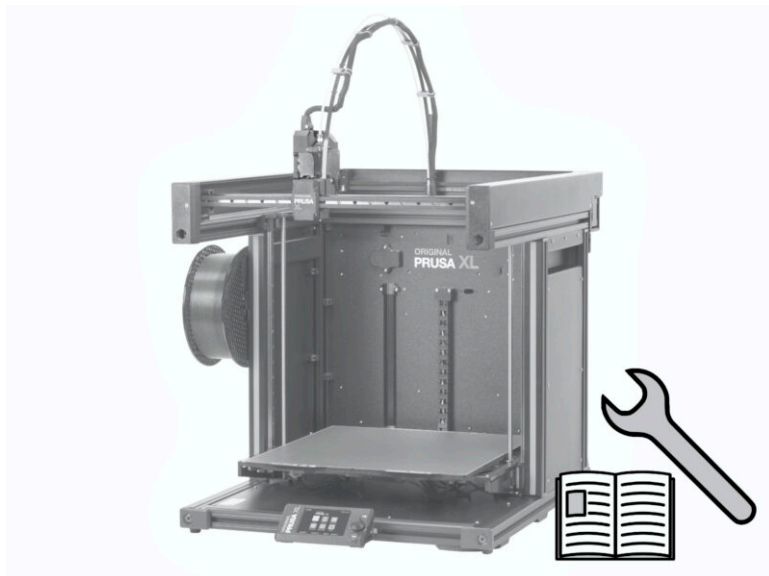

## STEP 1 Version history

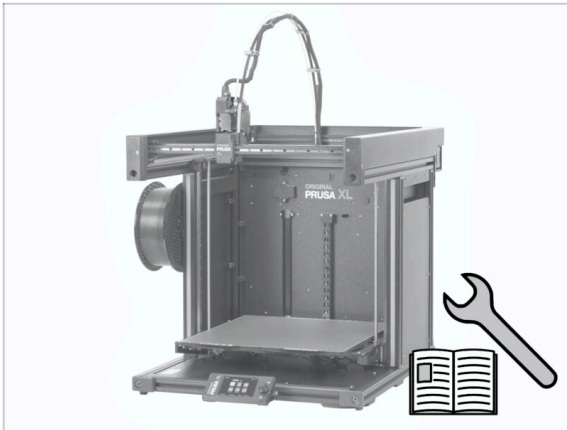

- ◆ **Versions of the Original Prusa XL semi-assembled (single tool) manual:**
- ◆ 06/2023 - Initial version 1.00
- ◆ 07/2023 - Updated to version 1.02
- ◆ 08/2023 - Updated to version 1.03
- ◆ 11/2023 - Updated to version 1.04
- ◆ 09/2024 - Updated to version 1.05

## STEP 2 Changes to the manual (1)

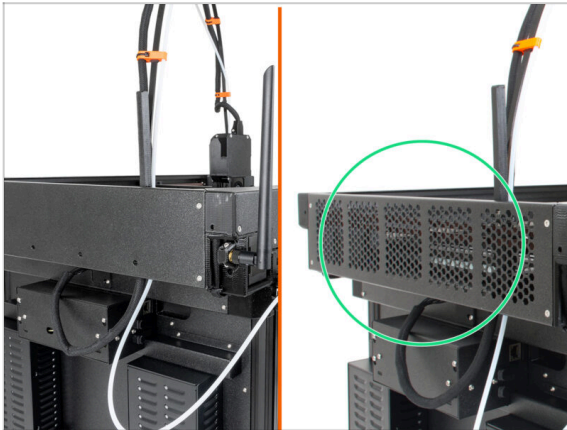

- ◆ 06/2023 - The CoreXY cover
- ◆ The CoreXY cover changed.
- ⓘ Manual version 1.01

### STEP 3 Changes to the manual (3)

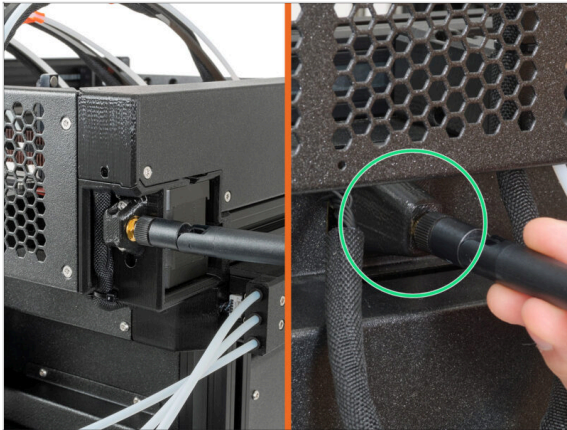

- 08/2023 - Antenna adapter
  - Added instructions for the new antenna adapter.
- Manual version 1.03

### STEP 4 Changes to the manual (2)

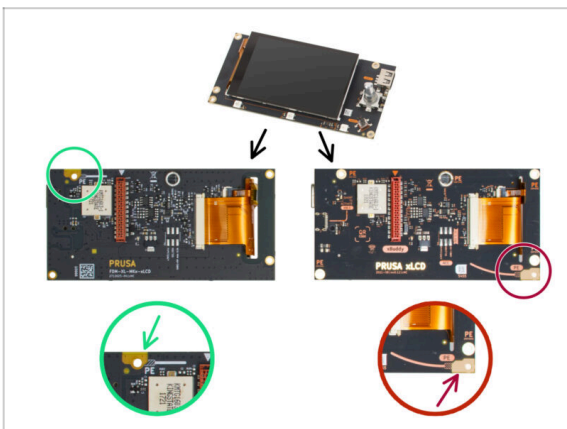

- 07/2023 - xLCD assembly
  - Added instructions for the new xLCD.
- Manual version 1.02

---

## STEP 5 Changes to the manual (4)



- 11/2023 - Spoolholder
  - Added instructions for the new injection molded Spoolholder.
- Manual version 1.04

---

## STEP 6 Changes to the manual (5)



- 09/2024 - xLCD
  - Added instructions for the new injection molded xLCD.
- Manual version 1.05















