

Table of Contents

1. Introduction	7
Step 1 - All the required tools are included	8
Step 2 - Universal wrench - description	8
Step 3 - Tools required for lubricating bearings	9
Step 4 - Labels guide	9
Step 5 - Use labels for reference	10
Step 6 - Spare bag	10
Step 7 - View high resolution images	11
Step 8 - We are here for you!	11
Step 9 - Important: Electronics protection	12
Step 10 - Pro tip: inserting the nuts	13
Step 11 - Pro tip: inserting the square nuts	13
Step 12 - Reward yourself	14
Step 13 - How to successfully finish the assembly	15
2. YZ - axis assembly	16
Step 1 - Tools necessary for this chapter	17
Step 2 - Y-carriage: parts preparation	17
Step 3 - Y-carriage: parts preparation (lubricating)	18
Step 4 - Lubricating the bearing	18
Step 5 - Lubricating the bearing	19
Step 6 - Correct bearing orientation	19
Step 7 - Installing bearings on the Y-carriage	20
Step 8 - Heatbed spacers: parts preparation	20
Step 9 - Installing the heatbed spacers	21
Step 10 - Y-axis front: parts preparation	21
Step 11 - Comparison of extrusions	22
Step 12 - Mounting the Y-plate-front	22
Step 13 - Mounting the MINI-Y-plate-front	23
Step 14 - Y-belt-idler: parts preparation	23
Step 15 - Preparing MINI-Y-belt-idler	24
Step 16 - Preparing MINI-Y-belt-idler	24
Step 17 - Mounting the MINI-Y-belt-idler	25
Step 18 - Y-axis smooth rods: parts preparation	25
Step 19 - Assembling the Y-carriage	26
Step 20 - Mounting the Y-carriage	26
Step 21 - Y-axis rear: parts preparation	27
Step 22 - Y-axis motor assembly	27
Step 23 - Mounting the Y-motor	28
Step 24 - Mounting the MINI-Y-rear-plate	28
Step 25 - Anti-vibration pads: parts preparation	29
Step 26 - Anti-vibration pads installation	29
Step 27 - Y-axis belt parts	30
Step 28 - Y-axis belt guidance	30
Step 29 - Aligning the Y-axis belt	31
Step 30 - Y-belt tensioning	31
Step 31 - Belt tension check	32
Step 32 - Y-axis assembly: reward yourself!	33
Step 33 - MINI-Z-bottom: versions	33
Step 34 - MINI-Z-bottom: parts preparation	34
Step 35 - Assembling the MINI-Z-bottom	34

Step 36 - Assembling the MINI-Z-bottom	35
Step 37 - Buddy board: parts preparation	35
Step 38 - Mounting the Buddy board	36
Step 39 - LCD cable: parts preparation	36
Step 40 - Connecting the LCD cable	37
Step 41 - LCD cable guidance	37
Step 42 - Z-axis: parts preparation	38
Step 43 - Assembling the Z-axis	38
Step 44 - Assembling the Z-axis	39
Step 45 - Assembling the Z-axis	39
Step 46 - Connecting the Y and Z-axis	40
Step 47 - Joining the Y and Z-axis together	40
Step 48 - Joining the Y and Z-axis together	41
Step 49 - Aligning the YZ-axis assembly	41
Step 50 - Securing the YZ-axis assembly	42
Step 51 - Guiding the Y-axis motor cable	42
Step 52 - Y-axis motor cable guidance	43
Step 53 - Z-top: parts preparation	43
Step 54 - Assembling the MINI-Z-top	44
Step 55 - Assembling the MINI-Z-top	44
Step 56 - Z-axis smooth rods: parts preparation	45
Step 57 - Mounting the Z-axis smooth rods	45
Step 58 - Installing the Z-axis bearings	46
Step 59 - Mounting the MINI-Z-top assembly	46
Step 60 - Mounting the MINI-Z-top assembly	47
Step 61 - Plastic cover: parts preparation	47
Step 62 - Securing the MINI-Z-top assembly	48
Step 63 - YZ-axis assembly: reward yourself!	48
Step 64 - YZ-axis is finished!	49
3. X-axis & Extruder assembly	50
Step 1 - Tools necessary for this chapter	51
Step 2 - Z-carriage: versions	51
Step 3 - Version A: Z-carriage: parts preparation	52
Step 4 - Version A: Assembling the Z-carriage	52
Step 5 - Version B: Z-carriage: parts preparation	53
Step 6 - Version B: Assembling the Z-carriage	53
Step 7 - Assembling the Z-carriage: parts preparation	54
Step 8 - Assembling the Z-carriage	54
Step 9 - X-end: parts preparation	55
Step 10 - X-end: parts preparation (lubricating)	55
Step 11 - Lubricating the bearings	56
Step 12 - Lubricating the bearings	56
Step 13 - Marking the bearings	57
Step 14 - Assembling the X-end	57
Step 15 - Assembling the X-end	58
Step 16 - Assembling the X-axis	58
Step 17 - Checking the smooth rods: X-end	59
Step 18 - X-carriage: parts preparation	59
Step 19 - Assembling the X-carriage	60
Step 20 - Mounting the X-carriage	60
Step 21 - X-axis motor: parts preparation	61
Step 22 - Assembling the X-axis motor	61
Step 23 - Mounting the X-axis motor	62
Step 24 - X-axis belt guidance	62

Step 25 - X-axis belt guidance	63
Step 26 - X-axis assembly: reward yourself!	63
Step 27 - Z-carriage: parts preparation	64
Step 28 - Preparing the Z-carriage	64
Step 29 - Mounting the X-axis	65
Step 30 - Mounting the X-axis	65
Step 31 - Plastic cover: parts preparation	66
Step 32 - Guiding the X-axis motor cable	66
Step 33 - Connecting the X-axis motor	67
Step 34 - X-axis belt tensioning	67
Step 35 - Belt tension check	68
Step 36 - Securing the X-end	68
Step 37 - Extruder motor: parts preparation	69
Step 38 - Assembling the Extruder motor	69
Step 39 - Extruder-front: parts preparation	70
Step 40 - Assembling the Extruder-front	70
Step 41 - Extruder-rear: parts preparation	71
Step 42 - Assembling the Extruder-rear	71
Step 43 - Extruder-idler: parts preparation	72
Step 44 - Assembling the Extruder-idler	72
Step 45 - Extruder assembly: parts preparation	73
Step 46 - Assembling the Extruder	73
Step 47 - Assembling the Extruder	74
Step 48 - Assembling the Extruder	74
Step 49 - Mounting the MINI-Extruder-idler	75
Step 50 - Inserting the PTFE tube	75
Step 51 - Inspection-door: parts preparation	76
Step 52 - Mounting the Extruder	76
Step 53 - Mounting the Extruder	77
Step 54 - Extruder assembly: reward yourself!	77
Step 55 - X-axis is finished!	78
4. Print head & Heatbed assembly	79
Step 1 - Tools necessary for this chapter	80
Step 2 - Hotend & Print fan: parts preparation	80
Step 3 - Mounting the hotend	81
Step 4 - Mounting the print fan	81
Step 5 - Hotend fan: parts preparation	82
Step 6 - Assembling the hotend fan	82
Step 7 - Minda-holder: parts preparation	83
Step 8 - Assembling the Minda-holder	83
Step 9 - Mounting the MINI-minda-holder	83
Step 10 - SuperPINDA sensor: parts preparation	84
Step 11 - Installing the SuperPINDA sensor	84
Step 12 - Fan-spacer-clip: parts preparation	85
Step 13 - Guiding the hotend cables	85
Step 14 - Guiding the hotend cables	86
Step 15 - Guiding the hotend cables	86
Step 16 - PTFE tube - parts preparation	87
Step 17 - Mounting the PTFE tube	87
Step 18 - Print head: reward yourself!	88
Step 19 - Heatbed: parts preparation	88
Step 20 - Heatbed: parts preparation	89
Step 21 - Assembling the heatbed	89
Step 22 - Guiding the heatbed cables	90

Step 23 - Covering the heatbed cables	90
Step 24 - Covering the heatbed cables	91
Step 25 - Covering the heatbed cables	91
Step 26 - Mounting the heatbed assembly	92
Step 27 - Heatbed: reward yourself!	92
Step 28 - Printhead and Heatbed are finished!	93
5. LCD assembly & Electronics	94
Step 1 - Tools necessary for this chapter	95
Step 2 - LCD assembly: parts preparation	95
Step 3 - Mounting the LCD	96
Step 4 - Connecting the LCD	96
Step 5 - LCD cable guidance	97
Step 6 - LCD assembly: reward yourself!	97
Step 7 - Optional: ESP Wi-Fi Module	98
Step 8 - Power switch: parts preparation	98
Step 9 - Mounting the power switch	99
Step 10 - Connecting the power switch	99
Step 11 - Filament sensor: parts preparation (optional)	100
Step 12 - Filament sensor: parts preparation (optional)	101
Step 13 - Filament sensor assembling (optional)	101
Step 14 - Filament sensor assembling (optional)	102
Step 15 - Filament sensor assembling (optional)	102
Step 16 - Filament sensor assembling (optional)	103
Step 17 - Filament sensor installation (optional)	103
Step 18 - Connecting the filament sensor (optional)	104
Step 19 - Connecting the electronics	104
Step 20 - Connecting the electronics	105
Step 21 - Covering the electronics: parts preparation	105
Step 22 - Covering the electronics	106
Step 23 - Gluing the silver label	107
Step 24 - Electronics: reward yourself!	107
Step 25 - LCD assembly & Electronics are finished!	108
Step 26 - New vs old Spool holder assembly	108
6A. Spool holder assembly	109
Step 1 - Injection molded holder: parts preparation	110
Step 2 - Base assembly (part 1)	110
Step 3 - Base assembly (part 2)	111
Step 4 - Foam pads installation (part 1)	111
Step 5 - Foam pads installation (part 2)	112
Step 6 - Adjusting the spool holder width	112
Step 7 - Spool holder assembly: reward yourself!	113
Step 8 - Spool holder is assembled!	113
6B. Spool holder assembly	114
Step 1 - Tools necessary for this chapter	115
Step 2 - Spool holder: parts preparation	115
Step 3 - Spool holder: parts preparation	116
Step 4 - Assembling the spool holder base(s)	116
Step 5 - Adding the spool holder rails	117
Step 6 - Adjusting the spool holder width	117
Step 7 - Attaching anti-slip pads	118
Step 8 - Spool holder assembly: reward yourself!	118
Step 9 - Spool holder is assembled!	119
7. Preflight check	120

Step 1 - SuperPINDA sensor height adjustment	121
Step 2 - Finalising the assembly	121
Step 3 - Connecting the power supply	122
Step 4 - Finalizing	122
Step 5 - Printable 3D models	123
Step 6 - Prusa knowledge base	123
Step 7 - It works! Reward yourself.	124
Step 8 - Join Printables!	124
Manual changelog MINI+ kit	125
Step 1 - Version history	126
Step 2 - Changes to the manual (1)	126
Step 3 - Changes to the manual (2)	127
Step 4 - Changes to the manual (3)	127
Step 5 - Changes to the manual (4)	128
Step 6 - Changes to the manual (5)	128

1. Introduction



STEP 1 All the required tools are included

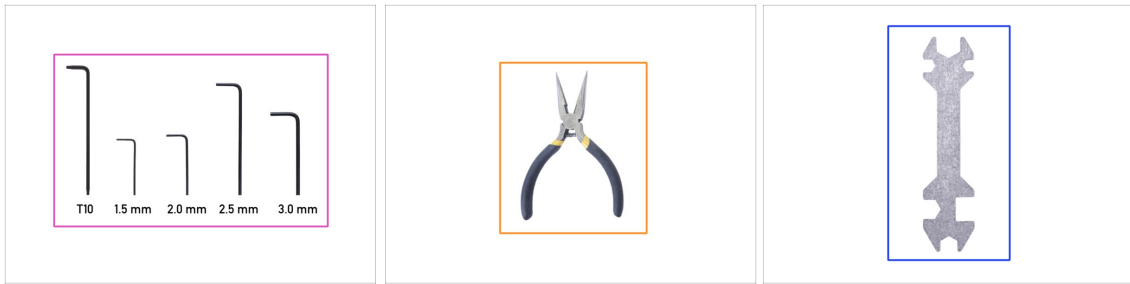

● The kit includes:

- ① The bag with tools is included in the **YZ & X-AXIS** box. Please prepare it now.
 - Allen keys *including one TORX key*
 - Needle-nose pliers (1x)
 - Universal wrench (1x)
- ① No soldering is required.
- ① No wire crimping is required.

STEP 2 Universal wrench - description

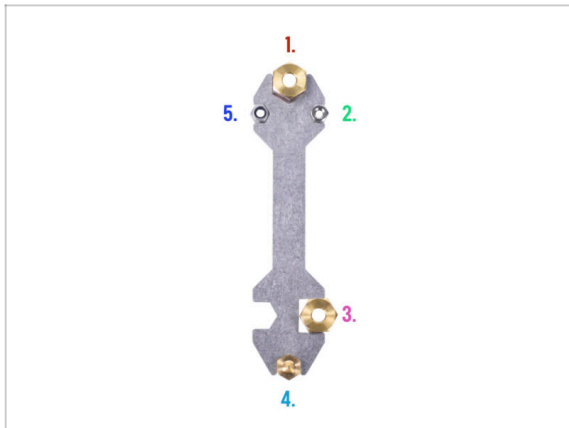

- The universal wrench is designed for tightening all these fasteners used on the MINI+ printer:
 - 1. Brass nut
 - 2. M3nN nyloc nut
 - 3. Brass nut
 - 4. Nozzle
 - 5. Heatbed spacer

STEP 3 Tools required for lubricating bearings



i In some chapters there are instructions for lubricating the bearings before using them.

◆ For these instructions, the kit includes:

- ◆** Prusa lubricant applicator (1x)
- ◆** Prusa lubricant (1x)

STEP 4 Labels guide



◆ All the boxes and bags including parts for the build are labelled.

◆ Each bag (or box) label describes in which chapter you will need it.

STEP 5 Use labels for reference

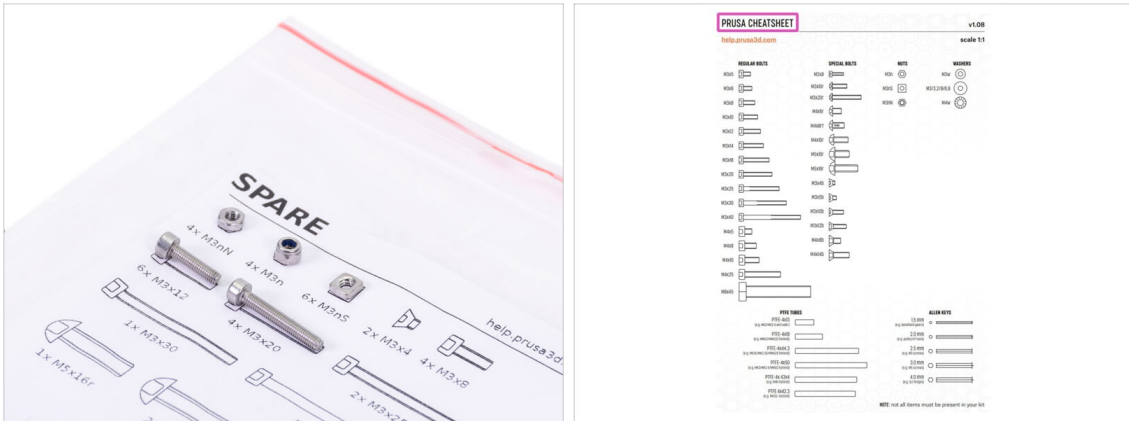

- Most of the labels are scaled 1:1 and can be used to identify the part :-)
- For the most common screws, nuts and PTFE tubes, you can also use the enclosed letter, which contains Prusa Cheatsheet on the other side.
- ⓘ You can download it from our site help.prusa3d.com/cheatsheet. Print it at 100 %, don't rescale it, otherwise, it won't work.

STEP 6 Spare bag



- Every type of fastener is included in a separate special bag.
- ⓘ If you lose a screw during assembly, use one from this bag.

STEP 7 View high resolution images

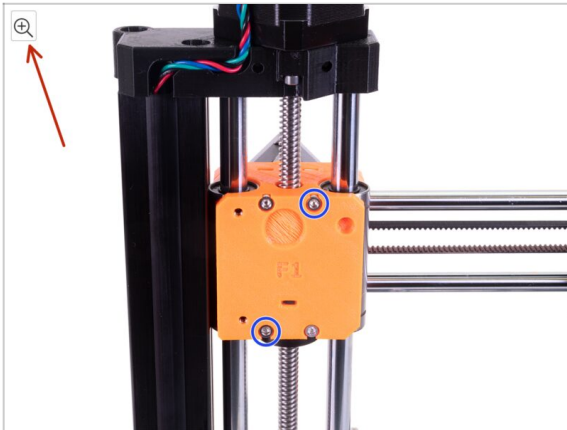

- i** When you browse the guide on help.prusa3d.com, you can view the original images in high resolution for clarity.
- ◆** Just hover your cursor over the image and click the Magnifier button ("View original") in the top left corner.

STEP 8 We are here for you!

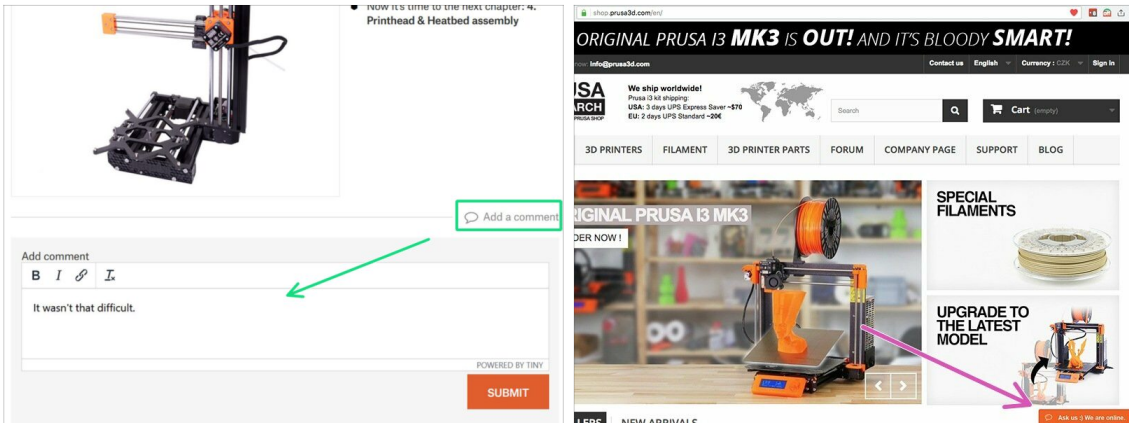

- ◆** Lost in the instructions, missing screw or cracked printed part? **Let us know!**
- ◆** You can contact us using following channels:
 - ◆** Using comments under each step.
 - ◆** Using our 24/7 live chat at shop.prusa3d.com
 - ◆** Writing an email to info@prusa3d.com

STEP 9 Important: Electronics protection



⚠ WARNING: Make sure to **protect the electronics against electrostatic discharge (ESD)**. Always unpack the electronics right before you need them!

- Here are some **tips to prevent damage to the electronics**:
 - **Keep the electronics inside the ESD bag** right until you are asked to install them.
 - **Always touch the sides of the board** while manipulating with it. Avoid touching the chips, capacitors and other parts of the electronics.
 - **Before you touch the electronics** use any conductive (steel) structure nearby to neutralize any electro-static energy.
 - **Be extra cautious in rooms with carpets**, which are a source of electrostatic energy.
 - Clothes made of wool and certain synthetic fabrics can easily gather static electricity. It is safer to wear **cotton clothing**.

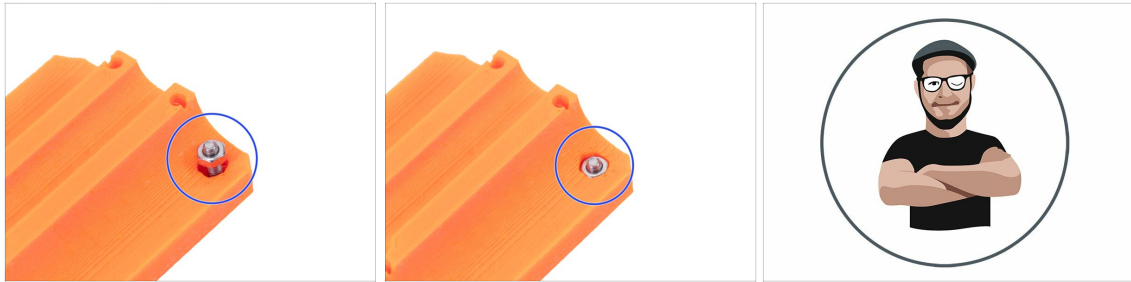
STEP 10 Pro tip: inserting the nuts

- 3D printed parts are very precise, however, there still might be an occasional lack of uniformity in the printed part and same goes for the size of the nut.
- Therefore it might happen, that the nut won't fit in easily or might be falling out. Let's see, how to fix it:
 - **Nut won't fit in:** use a screw with a thread along its entire length (typically: M3x10, M3x18) and screw it from the opposite side of the opening. While tightening the screw, the nut will be pulled in. Remove the screw afterwards.
 - Nut keeps falling out: Use a piece of tape to fix the nut temporarily in place, as soon as you insert the screw in, you can remove the tape. *Using glue isn't recommended as it can partly reach into the thread and you won't be able to tighten the screw properly.*
- Whenever you need to fit the nut that doesn't fit properly, we recommend using "screw pulling technique". You will be reminded with Joe's avatar ;)
- ⓘ Parts in the pictures are used as an example.

STEP 11 Pro tip: inserting the square nuts

- ⚠ **Always check** the correct position of the M3nS nuts in the printed parts immediately after insertion. Improperly inserted nuts will not allow proper assembly of parts.
- **Make sure the nut is inserted all the way in.** Use the following methods:
 - Use a 2.0mm Allen key for easier insertion into the hole.
 - Check the hole alignment by using a 2.0mm Allen key.
 - Check visually if the hole in the nut is aligned with the hole in the printed part.

STEP 12 Reward yourself



- ◆ Building the MINI+ printer is a challenge unlike any other and you should reward yourself for every milestone you reach. **That is why a bag of Haribo Bears is included!**
- ⚠ **The biggest issue from the previous builds (MK3S+, SL1) which we had to address was inadequate bear consumption. Many of you didn't have enough bears for all chapters, some even ate them all before they started!**
- ◆ After completing each chapter or challenging section of the chapter, you will be prompted to replenish energy for the following steps.
- ◆ **Don't eat all the bears before you start or at once!** Not following instructions will have serious consequences, we are currently assembling **Prusa Haribo tactical squad** for this matter.
- ⚠ **Hide the Haribo for now!** From our experience, an unattended bag with sweets tends to suddenly disappear. We are still investigating this phenomenon.
- ⓘ All information provided in this step is based on a long-term very serious research study ;)

STEP 13 How to successfully finish the assembly

Step 16 X-carriage assembly



⚠ For the following nut insertion **USE A SCREW. THAT'S AN ORDER!!!** Seriously, use a screw to pull the nuts in, both have to be properly seated in the X-carriage.

- Take both M3n nuts and using pliers (or screw) push them in the X-carriage, then using a screw from the other side, pull them all the way in.
- Don't forget to remove the screw.
- Take all four M3nS nuts and insert them in. Ensure correct alignment using the Allen key.

ⓘ From now on, keep in mind the nuts are inside, avoid rotating the X-carriage "downwards", or the nuts might fall out.

[Add a comment](#)

Step 3 Placing the Z-screw covers

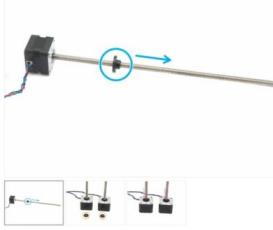

- For the following steps, please prepare:
 - Z-axis motor (2x)
- ⓘ Note each Z-axis motor has different cable length. The shorter one must be on the left side, longer on the right side.
- Z-screw-cover (2x)
- Remove the trapezoidal nuts from the motors. **DON'T THROW** them away, you will need them!
- Screw the Z-screw covers onto both leadscrews.

⚠ Covers should be screwed fully to the motor, but not too tight! The motor must be able to spin freely!

[49 comments](#)

It's easy on this step to overlook the addition of the Z screw covers. The names are a bit generic. It would help if the screw covers were orange instead of black (or just not black) so they stand out in the pictures and can be seen as distinct from the trapezoidal nuts.

David J. Cantrell

[Reply](#)



To successfully finish the assembly please complete each of the following:

- **Always read all the instructions at the current step first.** This will help you to understand, what you need to do. **Don't cut or trim unless you are told to!!!**
- **Don't follow pictures only!** It is not enough, the written instructions are as brief as they can be. Read them.
- **Read the comments** from the other users. They are a great source of ideas. We read them too and based on your feedback improve the manual and the entire assembly.
- **Use a reasonable force.** The printed parts are tough, but not unbreakable. If it doesn't fit, check your approach twice.
- **Eat the gummy bears as instructed!** Disobedience won't be tolerated :D
- **Most important: Enjoy the build, have fun.** Cooperate with your kids, friends or partners. *However, we take no responsibility for possible fights ;)*
- Ready for more? Let's move to the next chapter: **2. YZ - axis assembly**

2. YZ - axis assembly



STEP 1 Tools necessary for this chapter

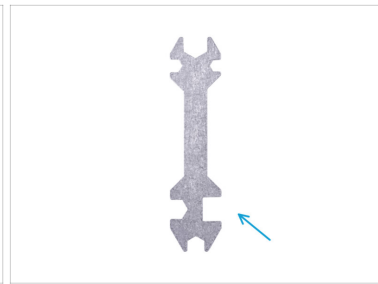
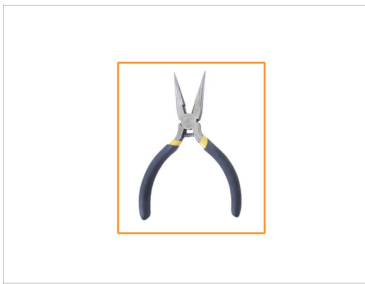
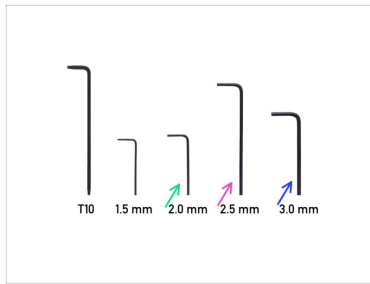

● **For this chapter please prepare:**

- 2.0mm Allen key
- 2.5mm Allen key
- 3.0mm Allen key
- Needle-nose pliers
- Universal wrench

STEP 2 Y-carriage: parts preparation



ⓘ All the printed parts and fasteners needed for this chapter are included in the box: **YZ & X-axis**

● **For the following steps, please prepare:**

- Y-carriage (1x)
- M3nN nyloc nut (6x)
- M3x10r screw (6x)
- Bearing clip (3x)
- Linear bearing LM8UU (3x)
*included in the **Rods** package*

ⓘ The list continues in the next step...

STEP 3 Y-carriage: parts preparation (lubricating)



● For the following steps, please prepare:

● Prusa lubricant applicator (1x)

● Prusa lubricant (1x)

● Several paper towels to wipe oil and grease from the bearing surface.

⚠ **Each bearing must be lubricated before mounting on the printer. Follow these instructions carefully.**

STEP 4 Lubricating the bearing



ⓘ Use any piece of fabric as a pad to protect your working surface from grease.

⚠ **Make sure the bearing is clean inside.**

● Wipe the preservative oil off the bearing surface with a paper towel.

● It is necessary to lubricate all 4 rows of balls inside the bearing.

● Open the lubricant and pierce the hole in the tube with the tip in the cap.

● Screw the tube into the applicator.

● Carefully slide the entire bearing onto the applicator.

STEP 5 Lubricating the bearing



- ◆ Turn the tube and applicator counterclockwise until you feel a slight resistance. This means that the holes in the applicator are aligned with the ball rows.
- ◆ Gently press the tube to push the lubricant into the ball rows of the bearing.
- ◆ Look at the front of the bearing. When the applicator pushes the lubricant out (around the black gasket), stop pressing the tube. Hold the bearing with the other hand during the lubricating.
- ⚠ **The grease must be spread evenly over all four ball rows inside the bearing. There must not be too much grease, or too little. Take a closer look at the last picture.**
- ◆ Wipe off excess grease on the outside of the bearing with a paper towel.
- ◆ Use this procedure for all three bearings.
- ◆ Do not remove the applicator from the tube. Keep it prepared for the next chapter.
- ⓘ The bearings may leave excess grease on the smooth rods after their installation. Wipe off any residue with a paper towel.

STEP 6 Correct bearing orientation



- ◆ **The correct orientation:** When placing bearings onto the Y-carriage, **make sure that they are oriented as shown** in both pictures. The tracks (rows of balls) have to be on the sides.
- ⚠ **The incorrect orientation: Avoid placing the bearing like in the last picture! This orientation with a single row of balls in the center will later increase the wear of the smooth rod, possibly creating a groove in it.**

STEP 7 Installing bearings on the Y-carriage

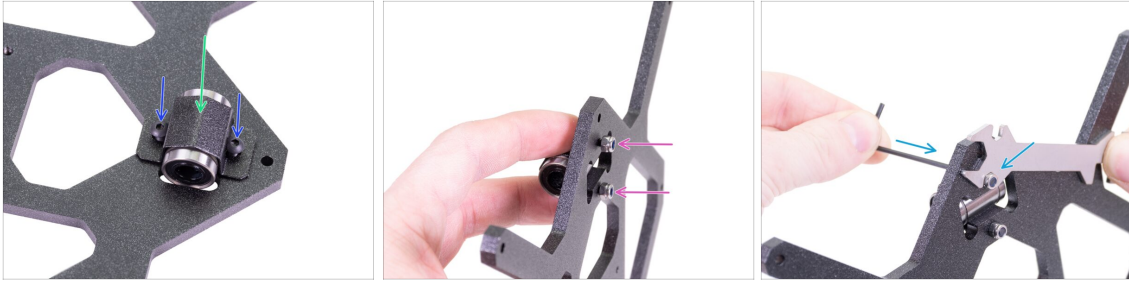

- Insert linear bearing in the center of the cutout. It doesn't matter which side. The top side and bottom side are the same.
- Place the bearing clip over the bearing.
- Insert two M3x10r screws into the holes in the bearing clip.
- Using your fingers, hold the heads of both screws and turn the Y-carriage. Place the nyloc nuts on both screws.
- Tighten both nuts by using the 2 mm Allen key and the universal wrench.
- Repeat these steps for the remaining two linear bearings.

STEP 8 Heatbed spacers: parts preparation

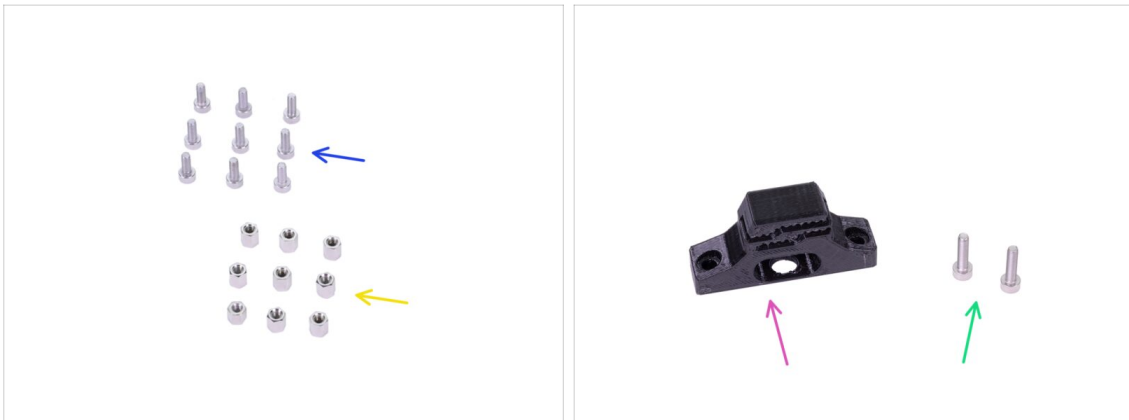

- **For the following steps, please prepare:**
- Heatbed spacer (9x)
- M3x8 screw (9x)
- MINI-Y-belt-holder (1x)
- M3x12 screw (2x)

STEP 9 Installing the heatbed spacers

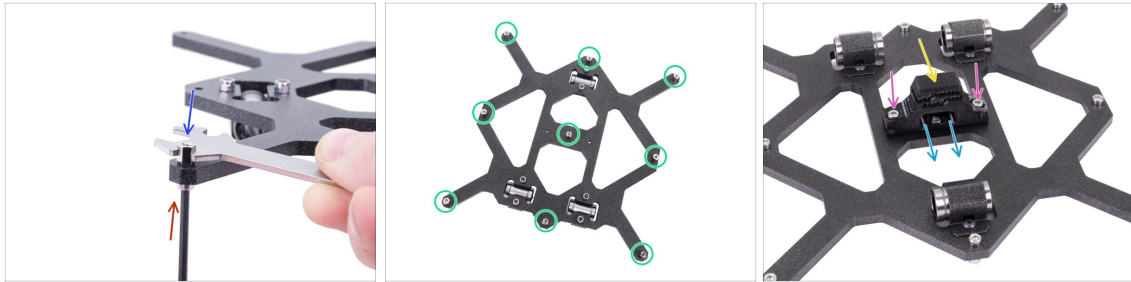

- Insert the M3x8 screw from the bottom of the Y-carriage (the side with bearings).
- Screw the heatbed spacer onto the screw from the top side of the Y-carriage and tighten it with the universal wrench and 2.5mm Allen key. **Tighten it firmly, but gently!**
- Use this procedure for all 9 heatbed spacers.
- Place the MINI-Y-belt-holder on the bottom side of the Y-carriage.
- Orient the holder so that the **side with the teeth faces the side with one bearing!!!**
- Double-check the MINI-Y-belt holder orientation!!!
- Secure it with two M3x12 screws. There is no need of a nut on the opposite side. There are threads in the Y-carriage.

STEP 10 Y-axis front: parts preparation



- **For the following steps, please prepare:**
- MINI-Y-plate-front (1x) with *Original Prusa MINI* logo on the front
- M5x20r screw (4x)

STEP 11 Comparison of extrusions



- Take all the extrusions and compare their lengths.
- You will need two shorter (262 mm) extrusions for the Y-axis assembly.

STEP 12 Mounting the Y-plate-front

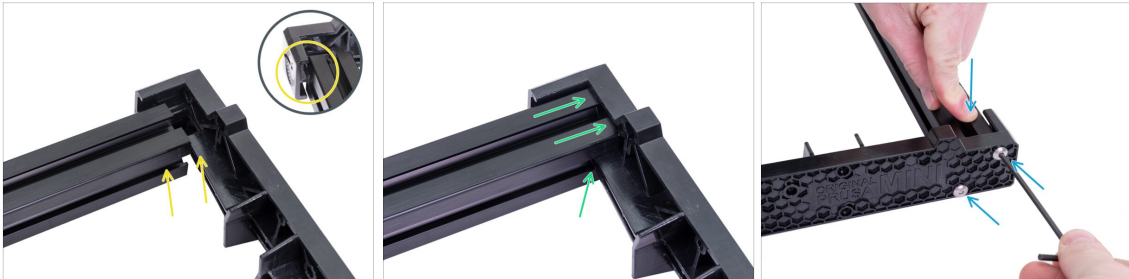

- Place the short extrusion to the left "inner" side of the MINI-Y-plate-front. See the protrusion on the plastic part. Do not place the extrusion directly on the protrusion on the left. There must be a gap. See the picture.
- Slide the extrusion onto the plastic part so that the protrusion fits in the extrusion.
- Secure both parts with two M5x20r screws. When tightening the M5x20r screws, push on the extrusion from above.

STEP 13 Mounting the MINI-Y-plate-front



- ◆ Place the short extrusion to the right "inner" side of the MINI-Y-plate-front. See the protrusion on the plastic part.
- ◆ Slide the extrusion onto the plastic part so that the protrusion fits in the extrusion.
- ◆ Secure both parts with two M5x20r screws. When tightening the M5x20r screws, push on the extrusion from above.

STEP 14 Y-belt-idler: parts preparation



- ◆ **For the following steps, please prepare:**
- ◆ MINI-Y-idler (1x)
- ◆ Pulley 623 2Z (1x)
- ◆ M3nN nyloc nut (1x)
- ◆ M3nS nut (2x)
- ◆ M3x20 screw (3x)

STEP 15 Preparing MINI-Y-belt-idler



- Take the MINI-Y-belt-idler and insert the M3nS nut from one side.
- Turn the idler 180° and insert the M3nS nut from the other side.
- Insert the M3nN nut into the hexagonal hole on the side. Push the nut as far down as possible.

 Always make sure that all M3nS nuts are inserted all the way down into the holes.

STEP 16 Preparing MINI-Y-belt-idler

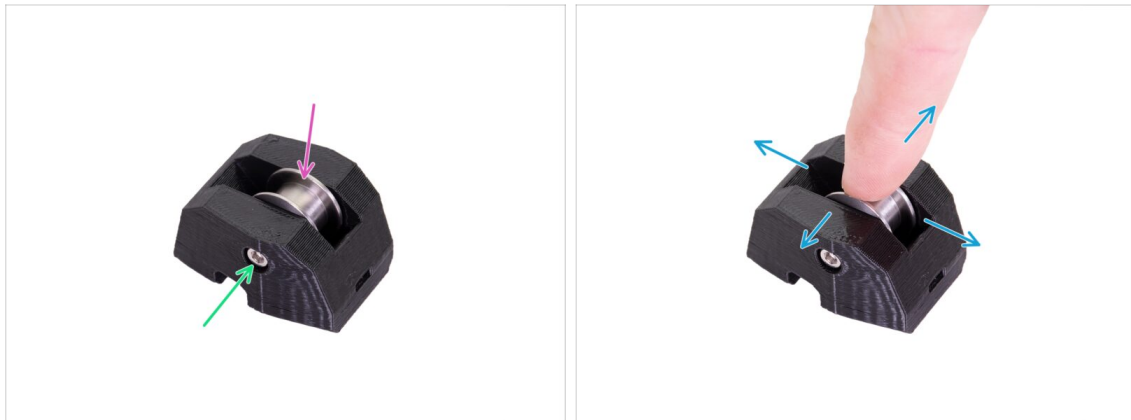

- Insert the pulley in the MINI-Y-belt-idler. The orientation of the pulley doesn't matter.
- Secure the bearing with the M3x20 screw. Don't fully tighten the screw.
- Place your finger on the bearing and ensure it can rotate freely. If needed, adjust the screw.

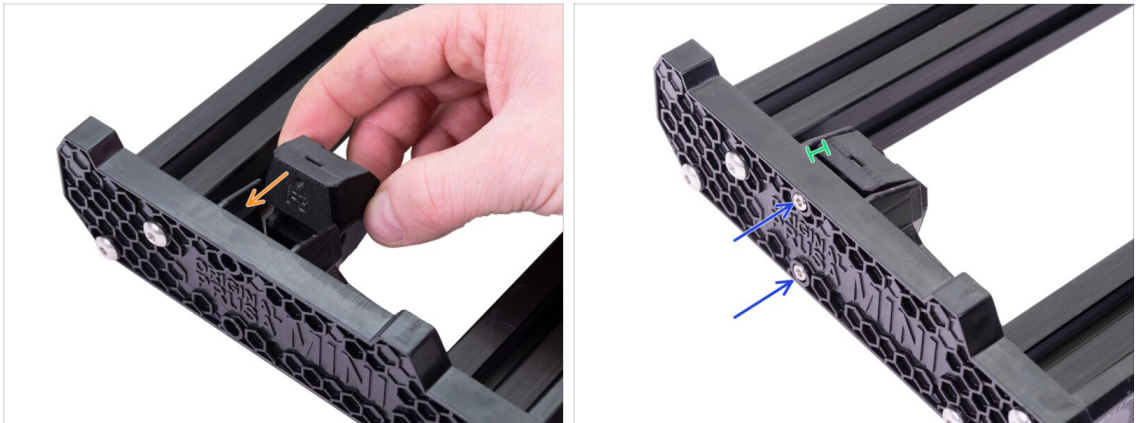
STEP 17 Mounting the MINI-Y-belt-idler

- Place the MINI-Y-belt-idler on the MINI-Y-plate-front. See the orientation of the part according to the picture.
- Secure the MINI-Y-belt-idler with two M3x20 screws.
- **Do not tighten the screws at this time.** Leave a gap of 1-2 mm between the MINI-Y-belt-idler and the MINI-Y-plate-front.

STEP 18 Y-axis smooth rods: parts preparation

- **For the following steps, please prepare:**
 - Smooth rods (2x)
 - **(i)** There are two sizes of the smooth rods. **Prepare two rods with the smaller diameter (8 mm) now.** Smooth rods with a larger diameter (10 mm) will be used later.
 - M3nE nut (3x)
 - **(i)** The **latest kit units contain M3nEs nuts.** The M3nEs nut is slightly different, it has a sheet metal spring. However, the installation procedure is the same.

STEP 19 Assembling the Y-carriage



⚠ NOW, PLEASE BE VERY CAREFUL! Gently insert the rod straight into the bearings. Do not apply too much force and do not tilt the rod!

- ◆ If you can't slide the smooth rod easily, check to make sure that the two bearings are aligned properly.
- ⓘ In case you manage to push out balls from the bearings, please count them. One or two balls are ok, if there are more of them, please consider ordering new bearings.
- ⓘ The bearings may leave excess grease on the smooth rods after their installation. Wipe off any residue with a paper towel.

STEP 20 Mounting the Y-carriage



- ◆ Place the Y-carriage on the extrusions. The side with **one bearing** must **face to the left**.
- ◆ Gently slide the smooth rods into the holes in the MINI-Y-plate-front. Start with the left rod, then the right one.
- ◆ Insert two M3nE into the side groove of the left extrusion (side with one bearing on the Y-carriage).
- ◆ Insert one M3nE nut into the upper groove of the left extrusion (side with one bearing on the Y-carriage).
- ⚠ **Before proceeding to the next step, make sure you have inserted all three M3nE nuts. Later insertion is difficult.**
- ⓘ Don't forget to **wipe off the residue of the grease on the smooth rods** with a paper towel.

STEP 21 Y-axis rear: parts preparation

For the following steps, please prepare:

- MINI-Y-plate-rear (1x)
- M5x20r screw (4x)
- Y-axis motor (1x)
- M3x12 screw (3x)
- Pulley T16-2GT (1x)

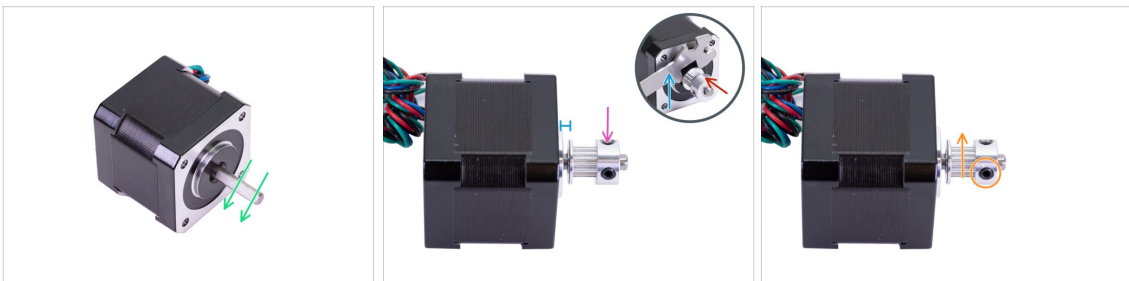
STEP 22 Y-axis motor assembly

- There is a flat part on the motor shaft, rotate it similarly to the first picture. See the direction of the arrows.
 - Place the pulley T16-2GT on the Y-motor shaft as shown in the picture.
 - Don't press the pulley against the motor. Leave a two-millimeter gap between both parts. Use the universal wrench to set the gap.
 - One of the screws must be facing directly against the pad (flat part) on the shaft. Slightly tighten the first screw.
 - Turn the shaft and slightly tighten the second screw.
- ⚠ Ensure you have the correct orientation of the pulley on the shaft. It can be placed both ways, but only one is correct.**

STEP 23 Mounting the Y-motor

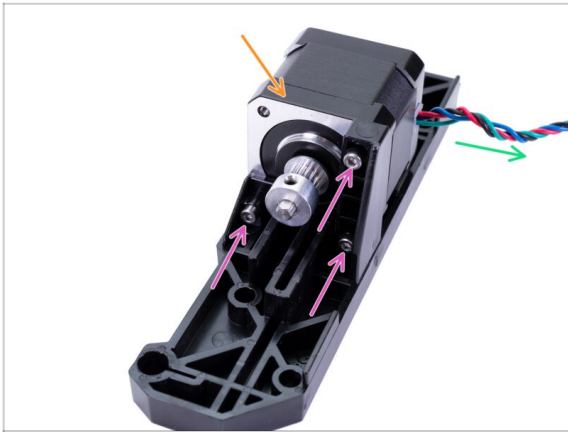

- Place the Y-axis motor to the holder on the MINI-Y-plate-rear part.
- Make sure the cable from the motor is oriented in the same way as in the picture.
- Secure the Y-axis motor with three M3x12 screws.

STEP 24 Mounting the MINI-Y-rear-plate

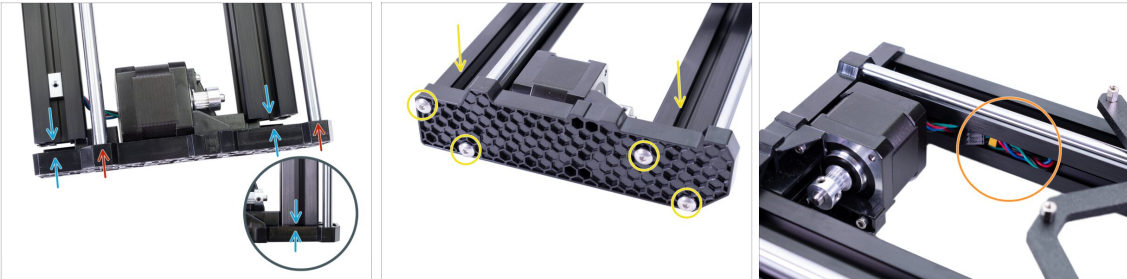

- ⚠ Once again, make sure that all three M3nE nuts are placed in the extrusion.**
- Place the MINI-Y-plate-rear on the smooth rods.
 - Push the MINI-Y-plate-rear all the way onto both extrusions.
 - Secure both parts with two M5x20r screws. When tightening the M5x20r screws, push on the extrusion from above.
 - To prevent damage to the Y-axis motor cable during the assembly, place the cable into the extrusion.

STEP 25 Anti-vibration pads: parts preparation



- ◆ For the following steps, please prepare:
- ◆ Anti-vibration foam pad set (1x)

STEP 26 Anti-vibration pads installation

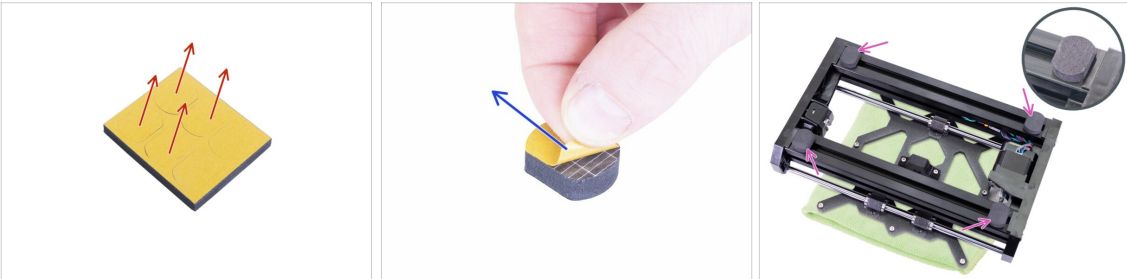

- ◆ Gently push four pads out of the block.
 - ⓘ Keep the other two pads for later.
 - ◆ Peel the protective film from all four pads.
 - ◆ Rotate the Y-axis so that the Y-carriage is facing down and glue four pads on the **aluminum extrusions**, like in the picture. Pay careful attention to the correct orientation.
 - ⓘ It is recommended to place the Y-carriage on a piece of fabric. Heatbed spacers can scratch your workbench.
- ⚠ **Do not glue any of these four pads on the plastic front and rear plate!**

STEP 27 Y-axis belt parts

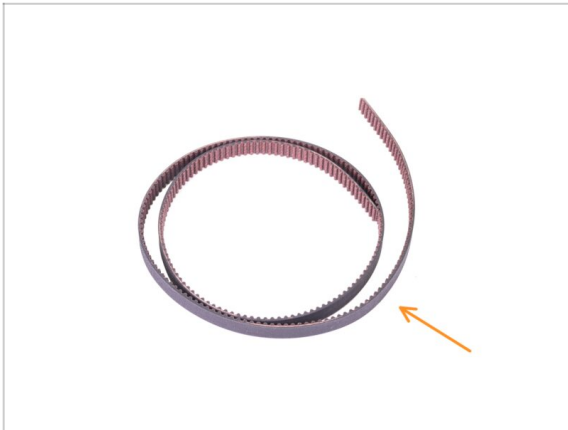

◆ For the following steps, please prepare:

- ◆ Y-axis belt 2GT 496 mm (1x)

STEP 28 Y-axis belt guidance

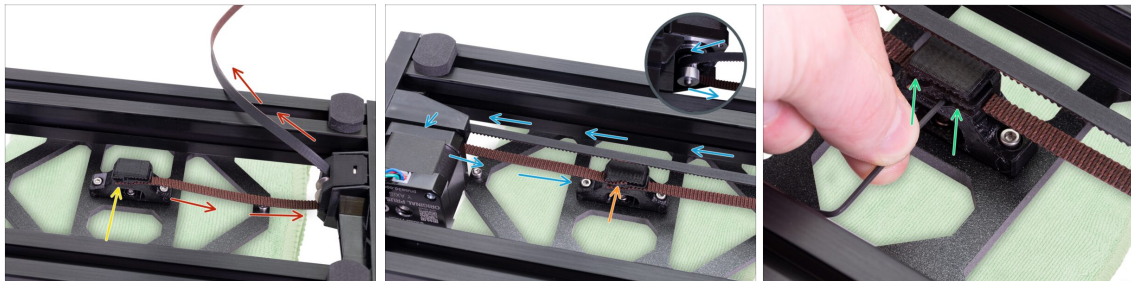

- ◆ Insert one end of the belt into the lower groove of the MINI-Y-belt-holder. Make sure the belt teeth are facing up.
- ◆ Guide the belt around the MINI-Y-belt-idler pulley.
- ◆ Guide the belt around the Y-axis motor pulley.
- ◆ Insert the second end of the belt into the upper groove of the MINI-Y-belt-holder.
- ◆ Secure both ends of the belts by squeezing them into the groove with the 1.5mm Allen key.

STEP 29 Aligning the Y-axis belt

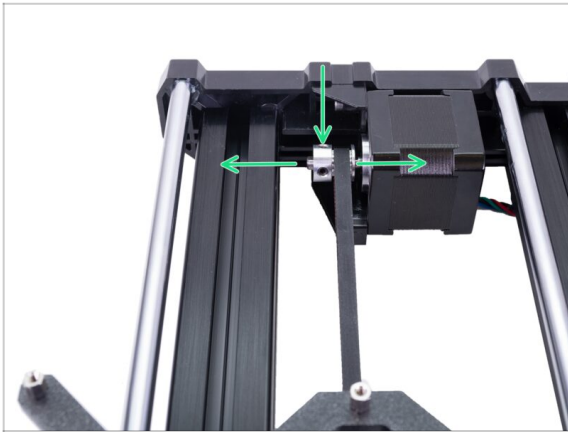

- Make sure the belt is placed in the "axis" of the printer. Both top and bottom part of the belt should be parallel (above each other).
- To adjust the belt position, release screws on the pulley, and with slight movements, proceed until you reach the best position.
- Tighten both screws on the pulley.
- ⓘ If the belt doesn't line up, check that the pulley is in the same orientation as seen in the picture.

STEP 30 Y-belt tensioning

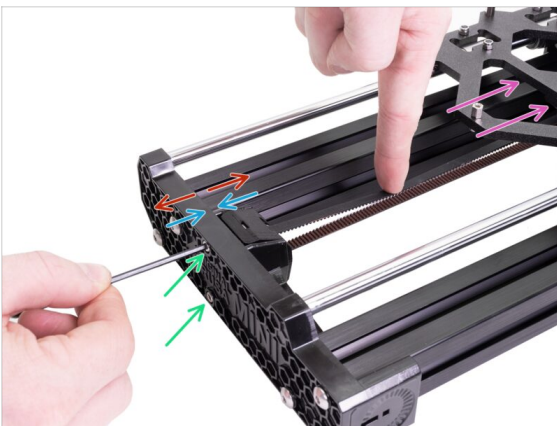

- Move the Y-carriage all the way from you.
- Using a finger on your left hand push the belt down. Some force should be needed for bending the belt, BUT don't try to overstretch the belt as you might damage the printer.
- You can change the tension in the belt by adjusting the two screws on the MINI-Y-plate-front:
 - **Tighten the screw**, bring the MINI-Y-belt-idler closer and thus increase the overall tension.
 - **Release the screw**, parts will move apart, the overall tension will decrease.
- Use the technique described below to test if the belt is properly stretched.
- Use pliers to hold the Y-axis motor shaft.
- Move the Y-carriage with your hand towards the Y-axis motor. Don't use excessive force.
- If the belt is stretched properly, you should feel a resistance and the Y-carriage won't move at all. If the belt is too loose, it will deform (create a "wave") and jump over the teeth on the pulley.

STEP 31 Belt tension check



- i** This step is recommended, but optional. If you don't have a phone at your disposal, continue to the next step. You can do this check later on.
- ◆** To verify or fine-tune the X or Y-axis belt tension on your printer, visit prusa.io/belt-tuner and open up the webpage on your mobile device. Or using your phone, scan the QR code in the picture.
- ◆** Follow the on-screen instructions to fine-tune the belt tension.
- i** The belt tuner app was tested on multiple phones and should work across all most common phone manufacturers. However, in some rare cases it might not work as expected. Please state your brand and model in the comments below the step.

STEP 32 Y-axis assembly: reward yourself!

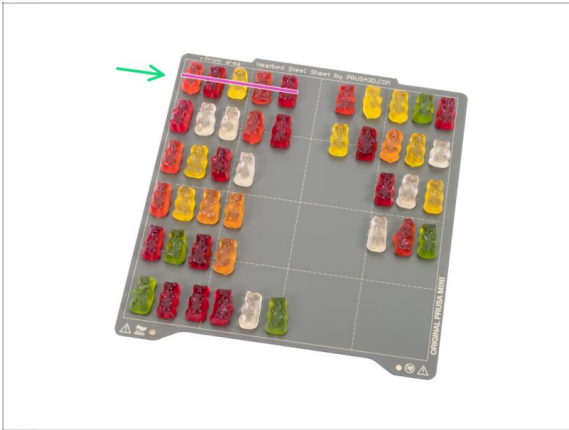

- ◆ You just finished the **Y-axis assembly**. It wasn't that hard, was it? Now is the time to reward yourself and replenish your energy for the next steps. Please, follow these instructions:

- ⚠ **Carefully and quietly** open the bag with the Haribo sweets. High level of **noise** might attract nearby predators!
- ⓘ Each row of the bears is intended for a specific chapter or is split into specific parts of the chapter. The number of the bears is sorted according to the difficulty of the chapter. But don't worry ;).
- ◆ Spread the bears in the six rows according to the picture. Start from the top.
- ⓘ If you are missing some bears, do not hesitate and immediately visit the nearest candy store and buy the missing amount ;).
- ⚠ **Keep the correct number of the bears in separate rows. That is crucial!**
- ◆ Eat the first part of the first row.

STEP 33 MINI-Z-bottom: versions

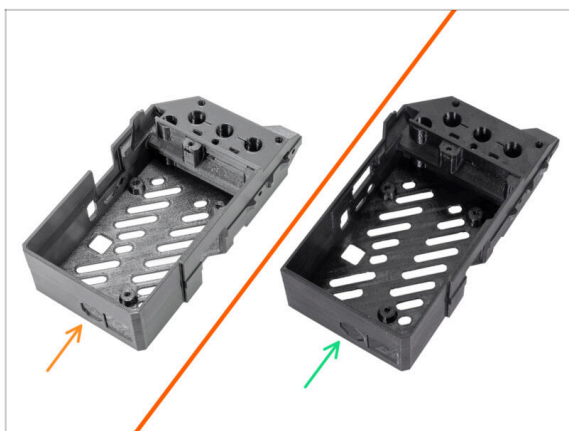

- ⓘ Starting from February 2025, you may receive a new MINI-Z-bottom.
- ◆ Version A: The newest version, assembling is the same as the old version
- ◆ Version B: The older version, assembling is the same as the new version

STEP 34 MINI-Z-bottom: parts preparation

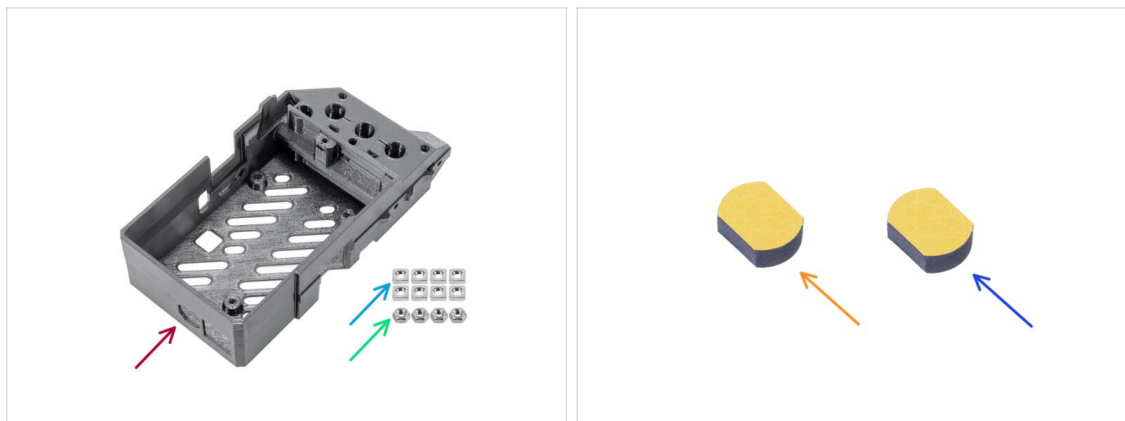

● For the following steps, please prepare:

ⓘ Fasteners needed for the following steps are in the Y & Z-axis package. Please, prepare this bag.

- MINI-Z-bottom (1x)
- M3n nut (4x)
- M3nS nut (8x)
- Anti-vibration foam pad (1x)
- The remaining foam pad is a spare.

STEP 35 Assembling the MINI-Z-bottom

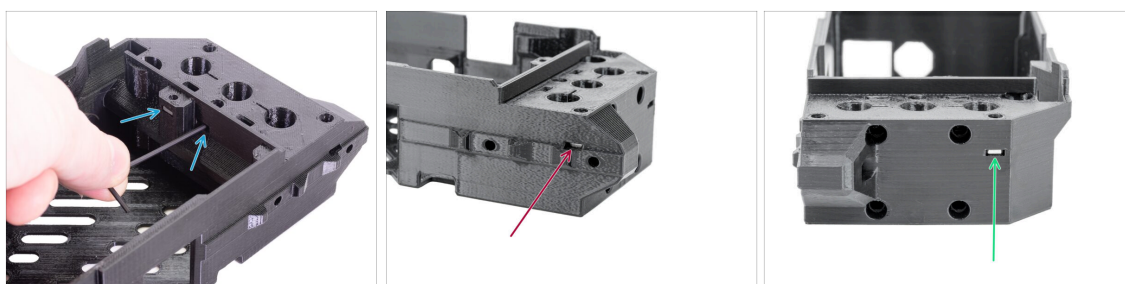

● Look inside the MINI-Z-bottom, locate two holes and insert two M3nS nuts. Use the 1.5mm Allen key to push the nuts fully inside.

● Insert one M3nS nut into the hole on the side.

● Insert one M3nS nut from the front side of the part.

⚠ Always make sure that **all M3nS nuts are inserted all the way down into the holes.**

STEP 36 Assembling the MINI-Z-bottom

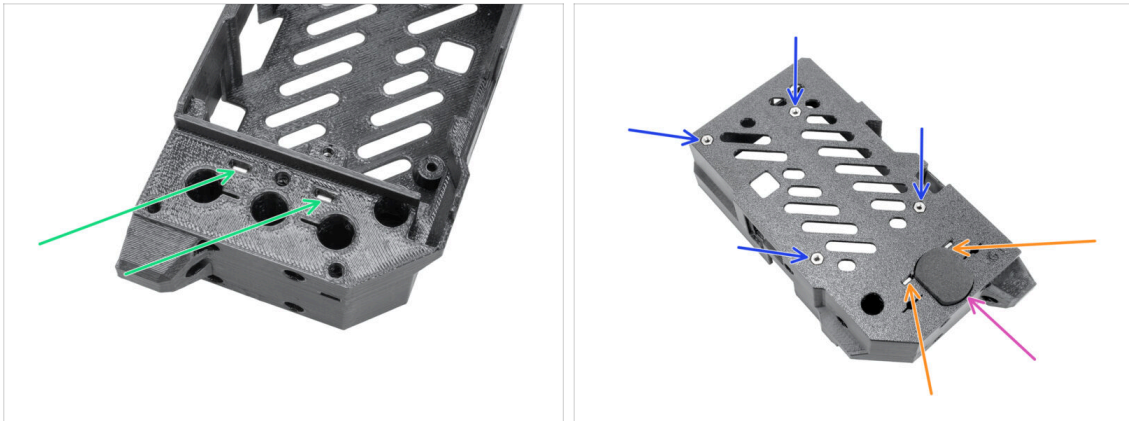

- Insert two M3nS nuts from the top side of the MINI-z-bottom.
- Turn the part upside down and insert two M3nS nuts.
- Insert four M3n nuts. Make sure they are flush (aligned) with the surface of the printed part. **Do not press too much on the bottom of the plastic part, it may crack.**
- Glue the anti-vibration pad in the recess shape of the pad.

STEP 37 Buddy board: parts preparation



● For the following steps, please prepare:

⚠ **WARNING:** Make sure to **protect the electronics against electrostatic discharge (ESD)**. Always unpack the electronics right before you need them!

● Buddy board (1x) *Keep the silver label for later!*

⚠ **New kit units are shipped with the silver label already affixed to the longest aluminum extrusion.**

ⓘ Note that the anti-static bag will be opened upon arrival. Each board is taken out and tested before shipping.

● M3x8 screw (4x)

STEP 38 Mounting the Buddy board

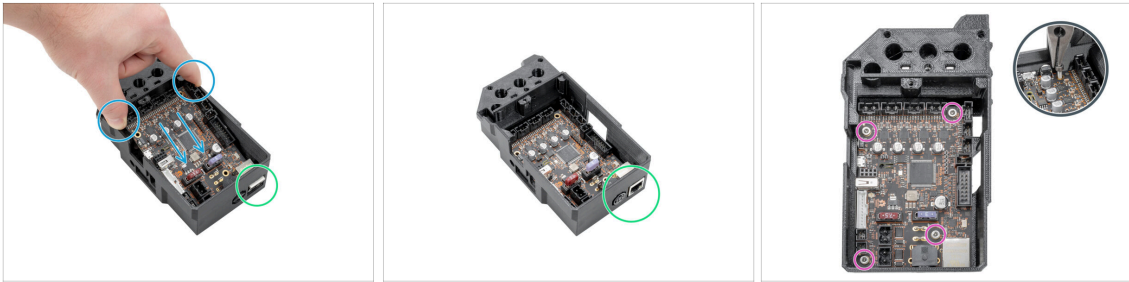

⚠ WARNING: Make sure to **protect the electronics against electrostatic discharge (ESD)**. Always unpack the electronics right before you need them!

- Grab the Buddy board on the sides and insert the board into the MINI-Z-bottom.
 - Make sure the LAN and power connectors are properly seated in the holes.
 - Secure the board with four M3x8 screws. **Do not tighten too much!** You can crack the Buddy board.
- i** You can insert the screws with the needle-nose pliers. **But be careful, avoid scratching the printed circuit board or bend the capacitors.** You can fatally damage the Buddy board.

STEP 39 LCD cable: parts preparation



● For the following steps, please prepare:

- LCD cable (1x)

⚠ The LCD cable is not symmetrical. Carefully read the instructions for the correct connection.

STEP 40 Connecting the LCD cable

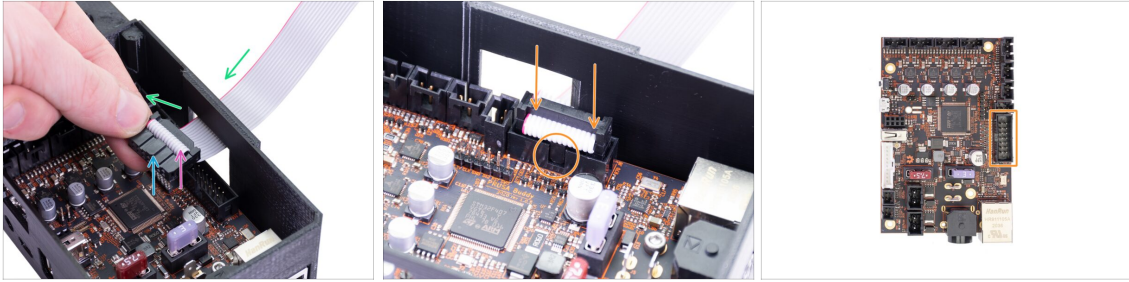

- ◆ Take the LCD cable and push it through the hole in the MINI-Z-bottom.
- ◆ Make sure the "tooth" on the connector is facing up.
- ◆ Make sure the cable fold in the connector is facing up.
- ◆ Connect the LCD connector to the board. Mind the orientation of the connector, there is a notch on one side (see the orange circle).

STEP 41 LCD cable guidance

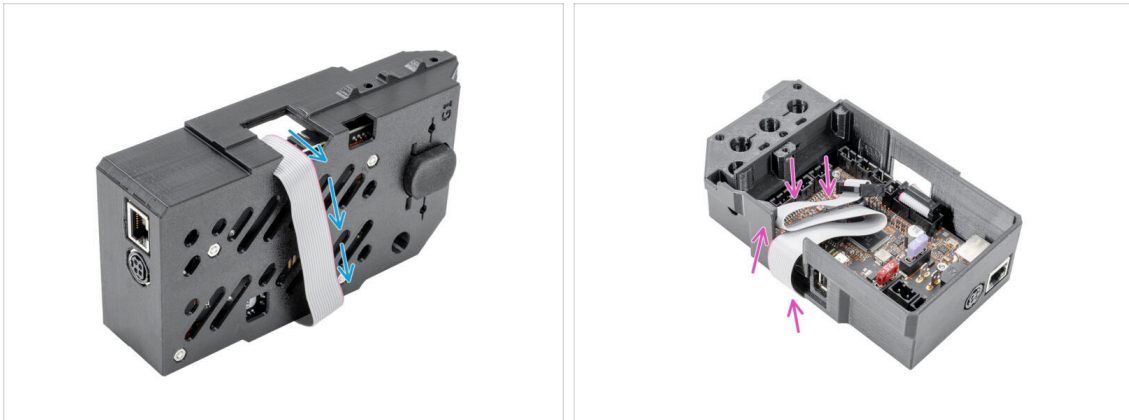

⚠ WARNING: From now on proceed carefully while moving the XZ-axis. The LCD cable is facing down and might get damaged.

- ◆ In order to protect the cable, please follow the instructions below. Also, don't try any other orientation, because it will complicate the assembly.
- ◆ Wrap the LCD cable around the box. Don't stretch the cable.
- ◆ Fold the second end of the cable inside the MINI-Z-bottom.

STEP 42 Z-axis: parts preparation



● For the following steps, please prepare:

- Extrusion 289 mm (1x)
- Z plate bottom (1x)
- M5x20r screw (2x)
- M3x12 screw (2x)
- M3x20 screw (3x)
- M3x40 screw (1x)

STEP 43 Assembling the Z-axis

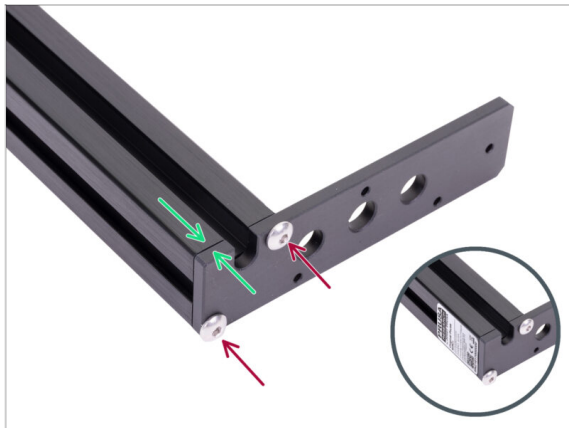

- Place the Z plate bottom part on the front of the extrusion like in the picture.
- Secure it with two M5x20r screws.
- ⓘ If you have the silver label already affixed to the extrusion from us, orient it to the same side, as in the picture.

STEP 44 Assembling the Z-axis

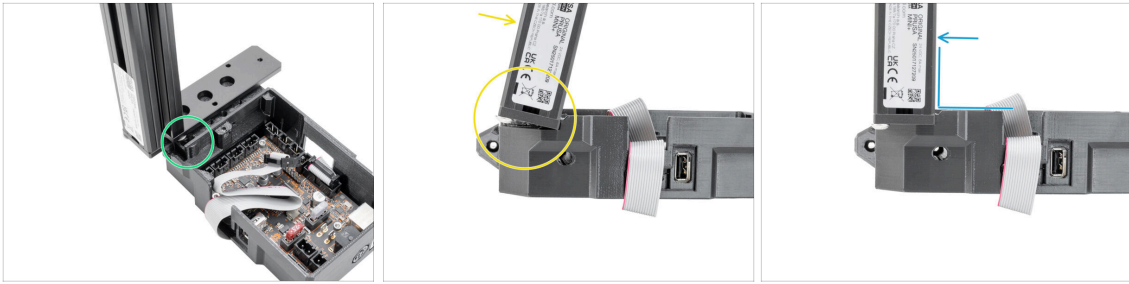

- ◆ There is a screw head on the underside of the Z plate bottom which must be properly seated in the round groove in the MINI-Z-bottom. Follow these instructions for the correct installation:
 - ◆ Place the extrusion assembly on the MINI-Z-bottom like in the picture and slightly tilt the extrusion. Move the inclined extrusion to the edge of the plastic part (see the yellow circle).
 - ◆ Straighten the extrusion to 90 °.

STEP 45 Assembling the Z-axis



- ◆ Make sure there is no large gap between the Z plate bottom and the plastic part.
- ◆ Secure the Z plate bottom with two M3x20 screws.
- ◆ Insert one M3x12 screw in the Z plate and tighten it.
- ◆ Insert the M3x40 screw into the hole in the MINI-Z-bottom.
- ◆ Using the 2.5mm Allen key insert the screw through the entire part so that a tip of the screw is visible on the other side.

STEP 46 Connecting the Y and Z-axis

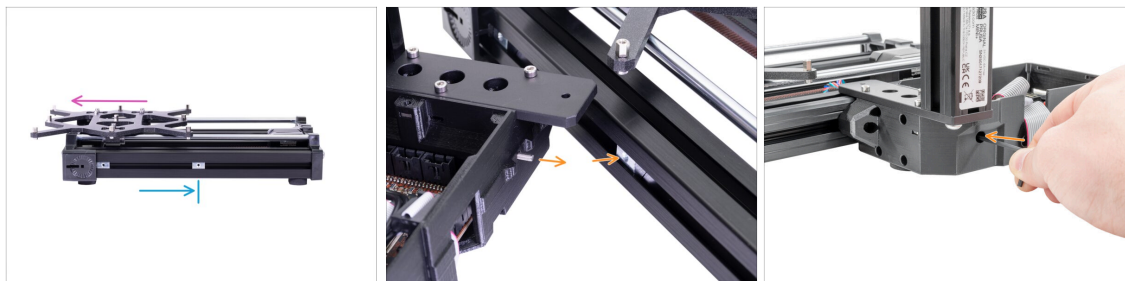

- ◆ Move the Y-carriage all the way to the left.
- ◆ Place the right M3nE nut approximately in the middle of the extrusion length.
- ◆ Align the Y-axis and Z-axis so that the protruding M3x40 screw points exactly at the hole in the M3nE nut in the extrusion. Join both parts together. **DON'T tighten the screw fully yet!**

STEP 47 Joining the Y and Z-axis together



- ◆ Take the second M3nE nut from the left and move it all the way to the right, use the Allen key and gently push it in. There is a notch inside, which will align it properly for the second screw.
- ◆ Use the M3x20 screw and again tighten it just slightly, but ensure you have reached the nut. **DON'T tighten the screw fully yet!**

STEP 48 Joining the Y and Z-axis together

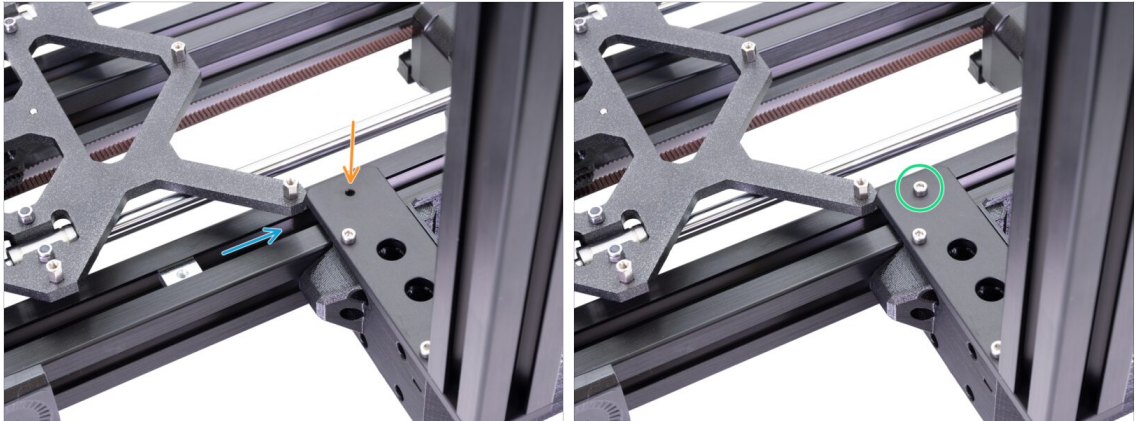

- Take the M3nE nut in the upper groove of the extrusion and slide it under the steel plate.
- Make sure the hole in the nut matches the hole in the plate. Use the Allen key to align it.
- Fix both parts together using the M3x12 screw, tighten it slightly. **DON'T tighten the screw fully yet!**

STEP 49 Aligning the YZ-axis assembly



- ⚠** In this step you will move the entire Z-axis, avoid pushing (grinding) it against the aluminium extrusion, or you might scratch it. Leave a small gap while moving the parts.
- Rotate the back of the printer towards you and push the Y-carriage all the way to the "front".
- Hold the Y-axis assembly.
- Move the Z-axis assembly to the back.
- There is a notch, which indicates the correct mutual position of both parts.

STEP 50 Securing the YZ-axis assembly

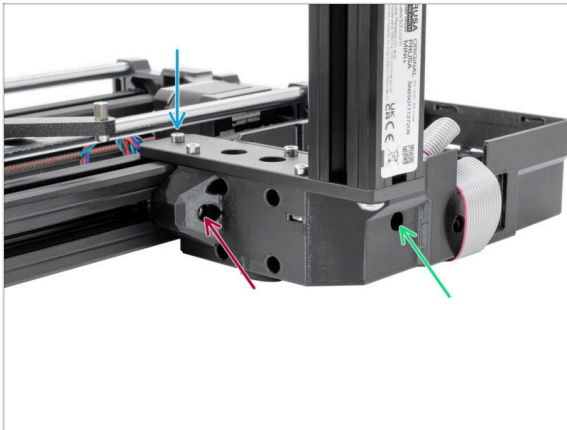

- Once the parts are aligned, **tighten all screws** in this particular order:
 - First, the M3x12 screw at the top.
 - Second, the M3x40 screw on the side.
 - Third, the M3x20 screw on the side.

STEP 51 Guiding the Y-axis motor cable

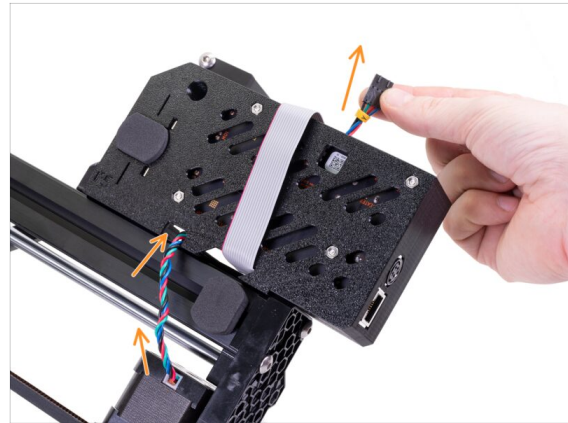
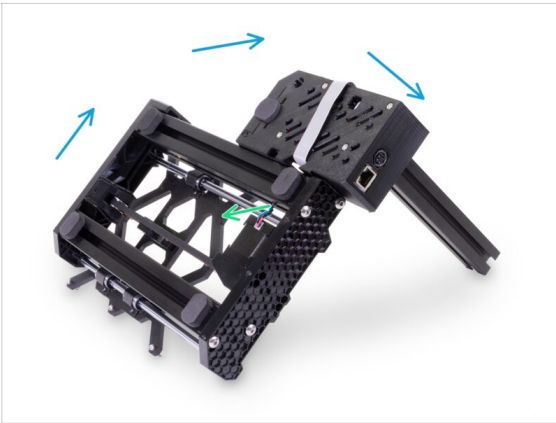

- Tilt the YZ-axis assembly as shown.
- Remove the Y-axis motor cable from the extrusion.
- Guide the Y-axis motor cable through the hole in the MINI-Z-bottom. Pushing the connector through the hole is tight, **be careful not to damage the connector**.
- Do not stretch the cable. Leave a small slack.

STEP 52 Y-axis motor cable guidance

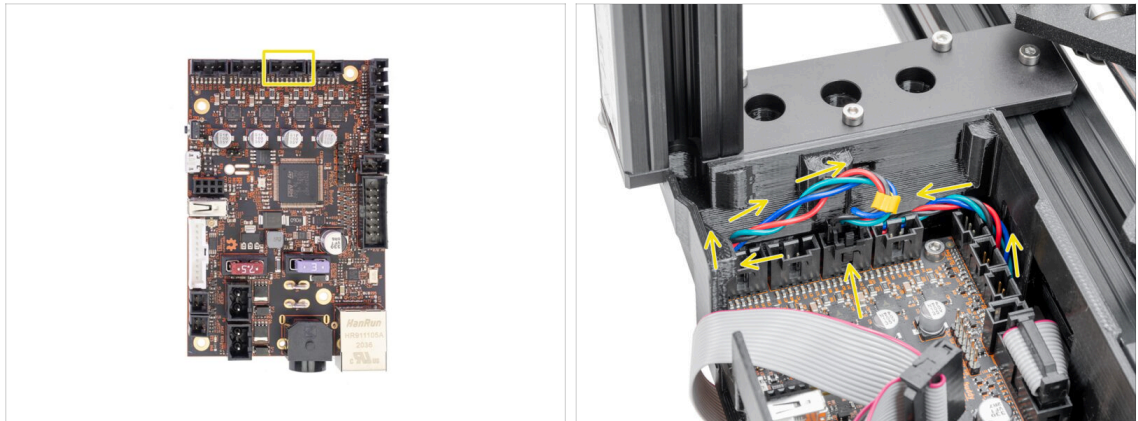

● Connect the Y-axis motor cable to the third slot from the left. Arrange the cable guiding according to the second picture.

⚠ Do not pull on the cable!

STEP 53 Z-top: parts preparation

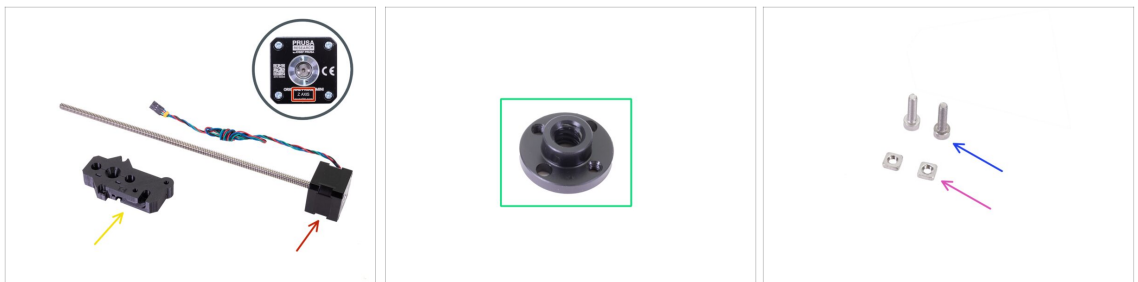

⬛ For the following steps, please prepare:

- MINI-Z-top (1x)
- Trapezoidal nut (1x)
- Z-axis motor (1x)
- M3nS nut (2x)
- M3x12 screw (2x)

STEP 54 Assembling the MINI-Z-top



- Insert two M3nS nuts all the way down into the MINI-z-top part. **Make sure the nuts are fully inserted.**

STEP 55 Assembling the MINI-Z-top

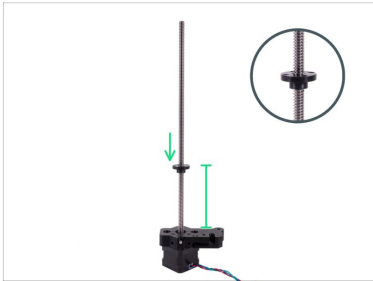
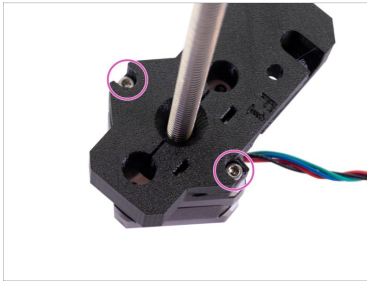
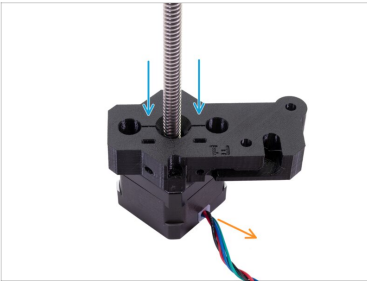

- Place the Z-axis motor like in the picture. Note the indicated cable direction.
- Place the MINI-Z-top on the Z-axis with the longest part on the right.
- Secure the MINI-Z-top with two M3x12 screws.
- Screw the trapezoidal nut up to 2/3 of the Z-axis motor length. **See the proper orientation of the nut.**

 **Double-check the orientation of the parts!**

STEP 56 Z-axis smooth rods: parts preparation

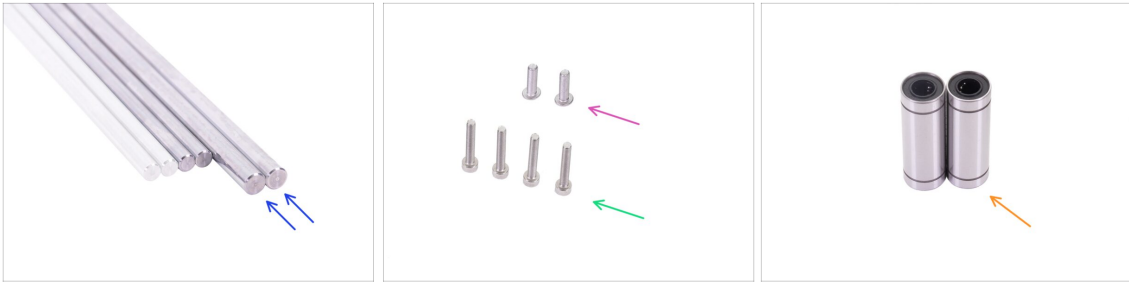

◆ **For the following steps, please prepare:**

- ◆ Smooth rod Z-axis (2x)

ⓘ Now use two rods with the larger diameter (10 mm).

- ◆ M3x20 screw (4x)

- ◆ M5x16r screw (2x)

- ◆ Linear bearing LM10LUU (2x) *included in the **Rods** package*

ⓘ LM10LUU bearings do not need lubrication.

STEP 57 Mounting the Z-axis smooth rods

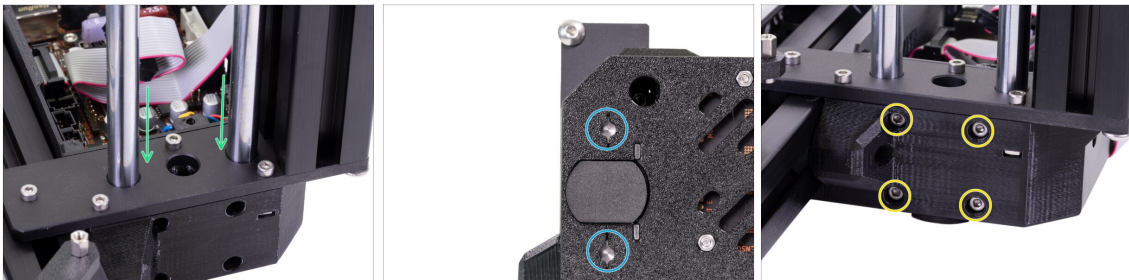

- ◆ Push both Z-axis smooth rods all the way into the MINI-Z-bottom.

ⓘ In case you find it difficult to insert the smooth rods, you can slightly loosen the screws on the Z plate bottom and tighten it again after insertion. **Don't forget to tighten them** after the insertion.

- ◆ Look at the MINI-Z-bottom from below and make sure that both smooth rods are fully inserted all the way down and touching the bottom.

ⓘ Some early units may have a narrower version of the inspection holes. In this case, it is recommended to illuminate the holes with a spotlight for better visibility of the smooth rods.

- ◆ Secure smooth rods with four M3x20 screws.

STEP 58 Installing the Z-axis bearings

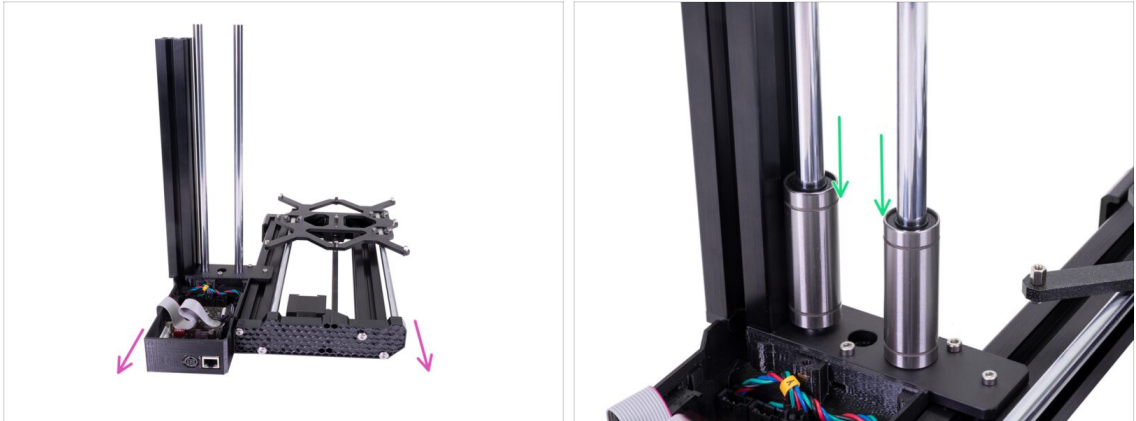

- ◆ Turn the YZ-axis assembly with the rear side facing you.
- ◆ Carefully put the bearings on the Z-axis rods. And slide them down.

STEP 59 Mounting the MINI-Z-top assembly

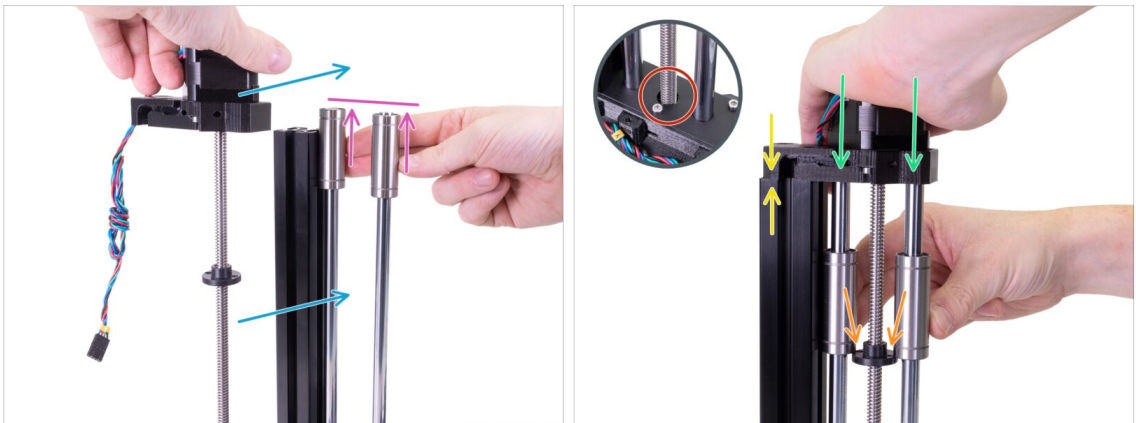

- ◆ Slide the bearings to the upper edge of the smooth rods and hold them by hand.
- ◆ With the other hand, position the Z-axis motor so that the trapezoidal nut is under the bearings.
- ◆ Slide the bearings down on the trapezoidal nut.
- ◆ Position the MINI-z-top on the extrusion and smooth rods. Then push the MINI-Z-top down on the rods.
- ⚠ **Do not tilt the motor when fitting! Insert straight, the threaded rod of the motor must fit into the hole in the Z plate bottom.**
- ◆ Check that the plastic part is seated correctly. There must be no gap between the plastic part and the extrusion.

STEP 60 Mounting the MINI-Z-top assembly



- Secure the MINI-z-top with two M5x16r screws.
- Guide the Z-motor cable down through groove in the MINI-Z-top and extrusion.
- Connect the Z-motor cable to the Buddy control board - first connector from the left.

STEP 61 Plastic cover: parts preparation

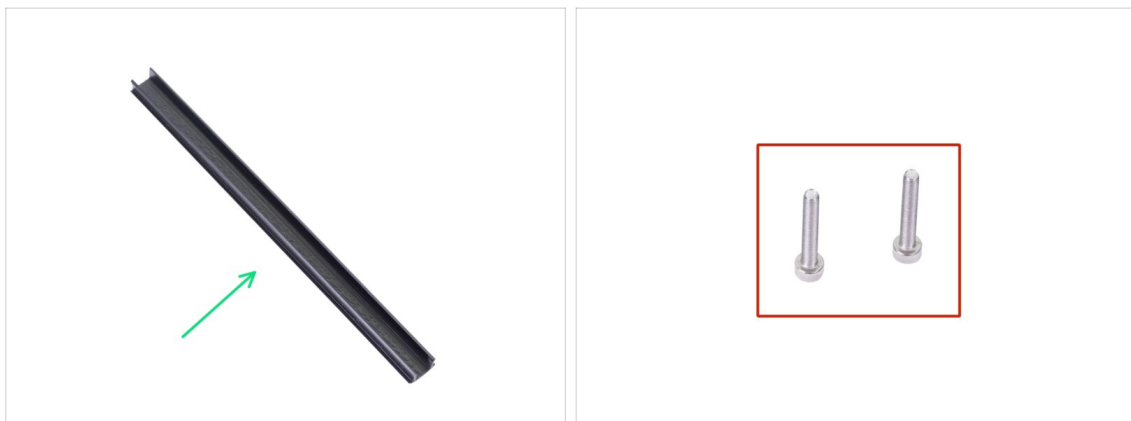

- For the following steps, please prepare:**
- Plastic cover (1x)
- M3x20 screw (2x)

STEP 62 Securing the MINI-Z-top assembly



- Place the plastic cover on the groove with the cable. Align it with the top edge of the extrusion.
- Insert and tighten M3x20 screws into the MINI-Z-top part from the opposite side of the YZ-axis assembly.

STEP 63 YZ-axis assembly: reward yourself!



- You just finished the **YZ-axis assembly**. It was a little challenging. Reward yourself!
- Eat the second part of the first row.

STEP 64 YZ-axis is finished!



- ◆ Check the final look, compare it to the picture.
- ◆ Checked everything? Continue with the chapter **3. X-axis & Extruder assembly.**

3. X-axis & Extruder assembly



STEP 1 Tools necessary for this chapter

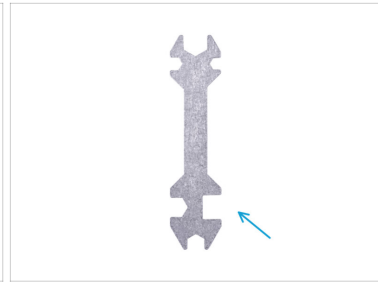
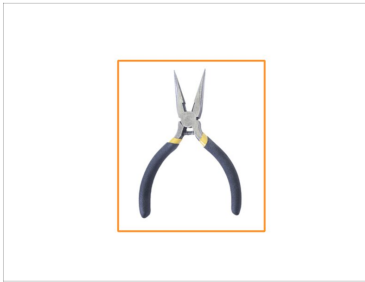
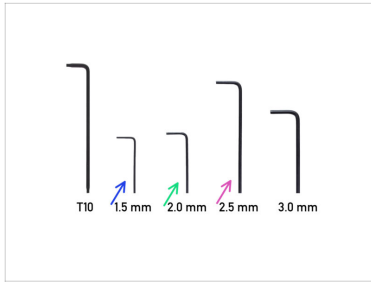

For this chapter please prepare:

- 1.5mm Allen key
- 2.0mm Allen key
- 2.5mm Allen key
- Needle-nose pliers
- Universal wrench

STEP 2 Z-carriage: versions

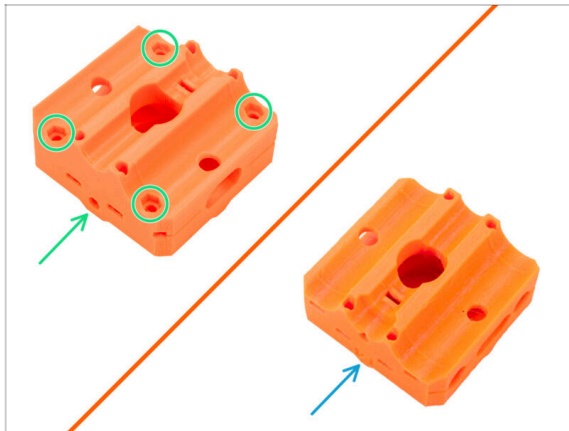

- i** Starting from February 2025, you may receive a new Z-carriage.
- Version A: The newest version with four M3n nuts from the bearing side, proceed to the **Version A: Z-carriage: parts preparation**
- Version B: The older version with four M3nS nuts from the upper and bottom side, proceed to the **Version B: Z-carriage: parts preparation**

STEP 3 Version A: Z-carriage: parts preparation

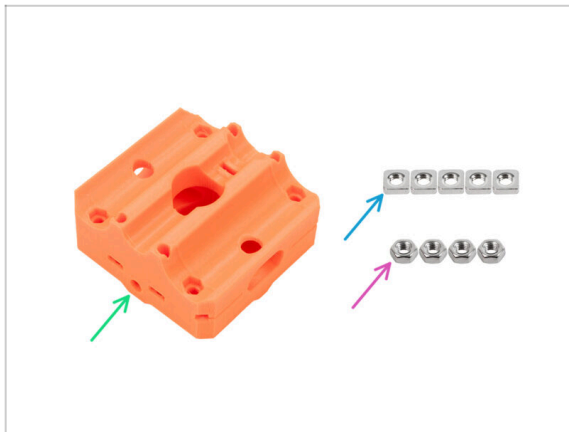

i All the printed parts and fasteners needed for this chapter are included in the box: **YZ & X-axis**

■ For the following steps, please prepare:

- MINI-Z-carriage-front (1x)
- M3nS nut (5x)
- M3n nut (4x) *from spare parts package*

STEP 4 Version A: Assembling the Z-carriage

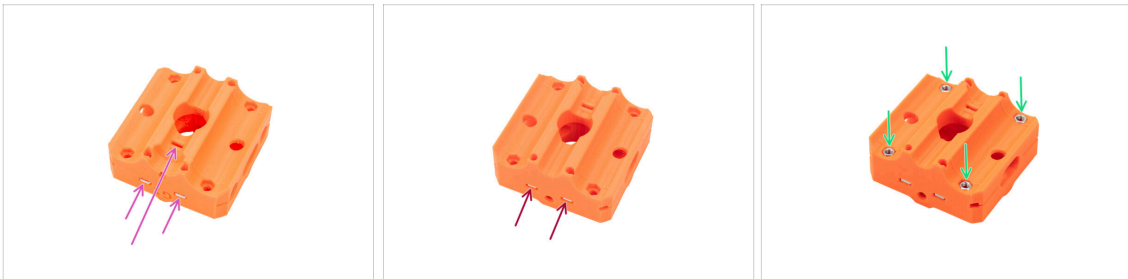

- Insert three M3nS nuts in the MINI-Z-carriage-front part.
- Turn the part upside down and insert two M3nS nuts in the bottom holes.
- Insert four M3n nuts in the top side of the MINI-Z-carriage-front.
- ⚠** Always **make sure that all M3nS nuts are inserted all the way down into the holes.** Use the 2.0mm Allen key to push the nuts fully inside.
- Now proceed to the **Assembling the Z-carriage: parts preparation**

STEP 5 Version B: Z-carriage: parts preparation

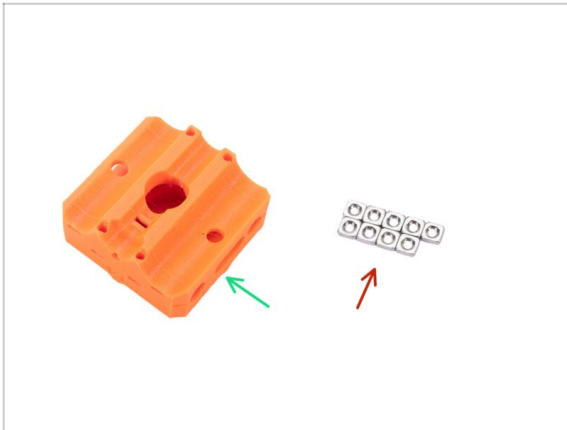

i All the printed parts and fasteners needed for this chapter are included in the box: **YZ & X-axis**

◆ For the following steps, please prepare:

◆ MINI-Z-carriage-front (1x)

◆ M3nS nut (9x)

STEP 6 Version B: Assembling the Z-carriage

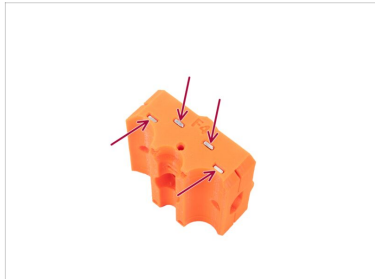
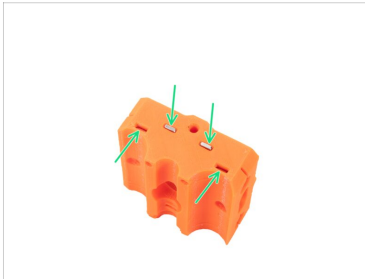

◆ Insert the M3nS nut in the MINI-Z-carriage-front part.

◆ Insert four M3nS nuts in the top side of the MINI-Z-carriage-front.

◆ Turn the part upside down and insert four M3nS nuts in the bottom holes.

⚠ Always **make sure that all M3nS nuts are inserted all the way down into the holes.** Use the 2.0mm Allen key to push the nuts fully inside.

STEP 7 Assembling the Z-carriage: parts preparation



● For the next steps, please prepare:

- Smooth rod (2x) 8 mm diameter
- M3x12 screw (4x)

STEP 8 Assembling the Z-carriage

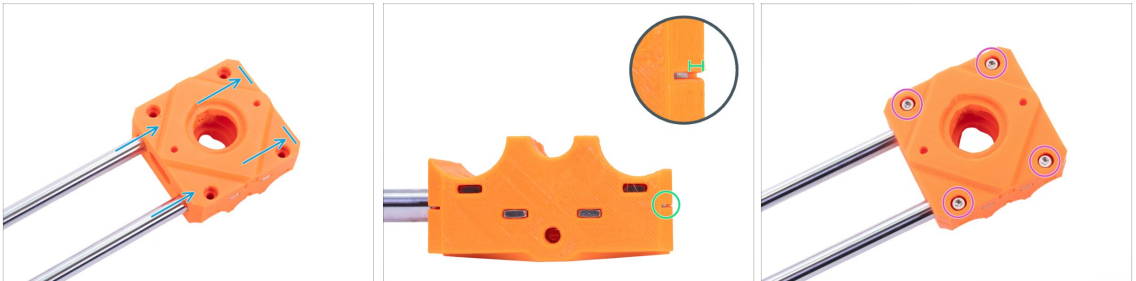

ⓘ This step is for both version of a Z-carriage.

- Carefully slide both smooth rods all the way into the MINI-Z-carriage-front. **Before inserting the smooth rods, check if there are no obstructions inside the holes.**
- Look sideways on the MINI-Z-carriage-front through the inspection hole and **check that the smooth rod is fully inserted into the plastic part.**
- Secure all parts together with four M3x12 screws.

STEP 9 X-end: parts preparation

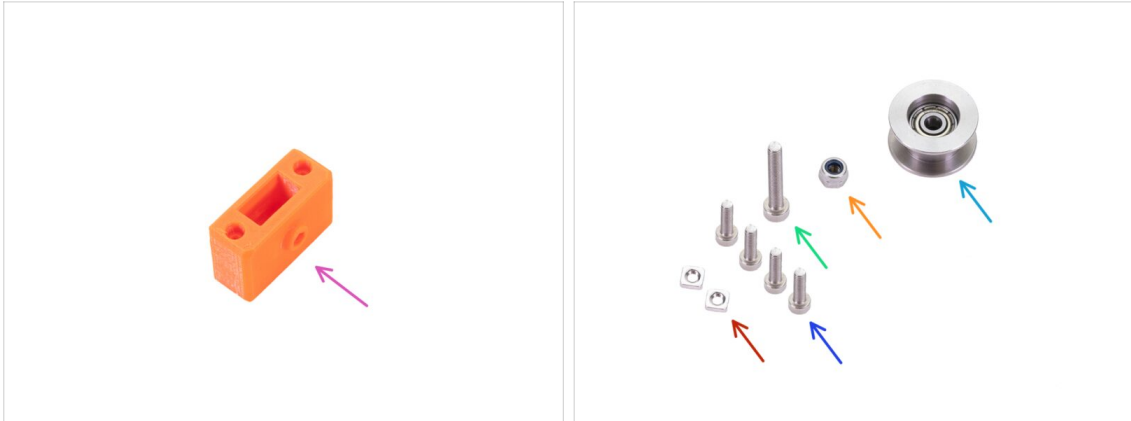

⬛ For the following steps, please prepare:

- 🟡 MINI-X-end (1x)
- 🔴 M3nS nut (2x)
- 🟠 M3x12 screw (4x)
- 🟢 M3x20 screw (1x)
- 🟠 M3nN nyloc nut (1x)
- 🔵 Pulley Bearing Idler 623 2Z (1x)
- 📄 ⓘ The list continues in the next step.

STEP 10 X-end: parts preparation (lubricating)



⬛ For the following steps, please prepare:

- 🟠 Linear bearing LM8UU (2x) *included in the Rods package*
- 🟢 Prusa lubricant applicator (1x)
- 🔴 Prusa lubricant (1x)
- 🟡 Several paper towels to wipe oil and grease from the bearing surface.
- ⬛ Permanent marker (1x) *not included in the kit*

⚠️ **Each bearing must be lubricated before mounting on the printer. Follow these instructions carefully.**

STEP 11 Lubricating the bearings



- i** Use any piece of fabric to protect your working surface from grease.
- !** **Make sure the bearing is clean inside.**
- Wipe the preservative oil off the bearing surface with a paper towel.
- It is necessary to lubricate all 4 rows of balls inside the bearing.

STEP 12 Lubricating the bearings



- Turn the tube and applicator counterclockwise until you feel a slight resistance. This means that the holes in the applicator are aligned with the ball rows.
- Gently press the tube to push the lubricant into the ball rows of the bearing.
- Look at the front of the bearing. When the applicator pushes the lubricant out (around the black gasket), stop pressing the tube. Hold the bearing with the other hand during the lubricating.
- !** **The grease must be spread evenly over all four ball rows inside the bearing. There must not be too much grease, or too little. Take a closer look at the last picture.**
- Wipe off excess grease on the outside of the bearing with a paper towel.
- Use this procedure for both bearings.

STEP 13 Marking the bearings



- Position the bearing so that you can see two rows of balls. Like in the picture.
- Make a mark with a permanent marker on the outer surface of the bearing, in the middle above two rows of balls.
- Use the same procedure on the second bearing.
- i** We will use these markings in the upcoming steps to achieve the desired bearing orientation.

STEP 14 Assembling the X-end

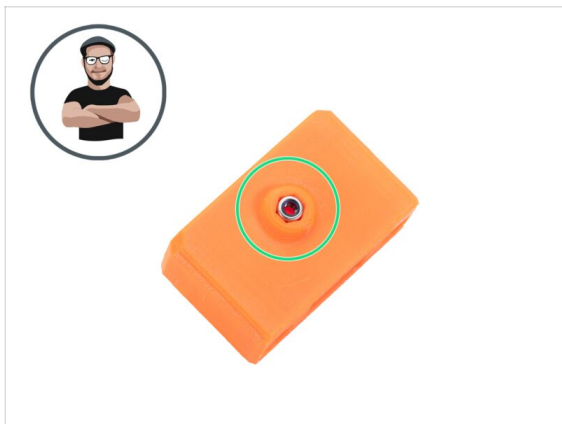
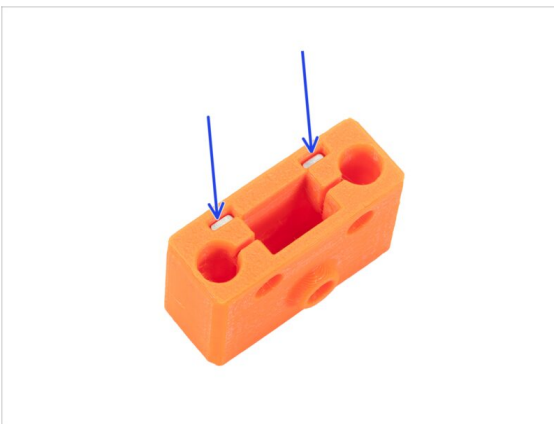

- Insert two M3nS nuts in the X-end.
- !** Always make sure that all M3nS nuts are inserted all the way down into the holes.
- Insert the M3nN nut into the X-end.
- i** Use the screw pulling technique.

STEP 15 Assembling the X-end



- ◆ Turn the X-end upside down.
- ◆ Place the pulley bearing idler into the X-end and align holes on both parts. The orientation of the pulley doesn't matter.
- ◆ Secure it with M3x20 screw.
- ◆ Place your finger on the bearing and ensure it can rotate freely. If needed to adjust the screw.

STEP 16 Assembling the X-axis

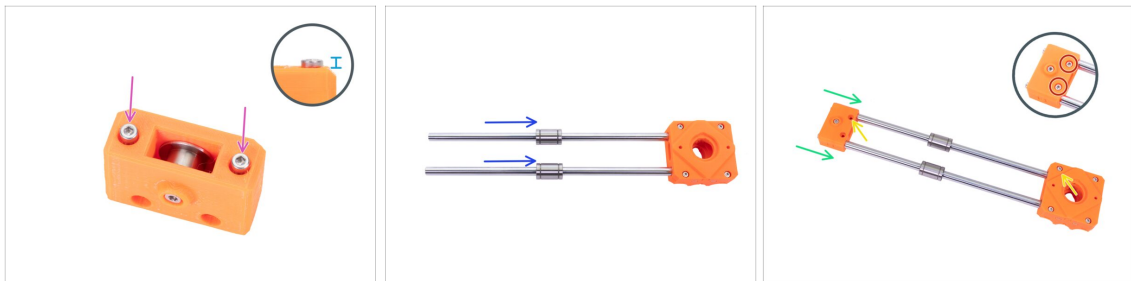

- ◆ Insert and slightly tighten two M3x12 screws into the X-end.
 - ⓘ There is no nut used here. Use more force to tighten the screws into the plastic part. **Be careful**, not to hurt yourself.
- ◆ Do not tighten the screws completely. Leave a half of the screw head protruding above the surface of the plastic part.
- ◆ Slide one bearing on each smooth rod.
 - ⓘ Don't forget to **wipe off the residue of the grease on the smooth rods** with a paper towel.
- ◆ Push the MINI-X-end all the way on the smooth rods. **Before pushing the part on the smooth rods, check if there are no obstructions inside the holes.**
- ◆ Check the correct orientation of the part. The screw holes on the MINI-X-end must face up and the screws on the MINI-Z-carriage-front must face up.
- ◆ Insert and slightly tighten two M3x12 screws into the X-end. We'll completely tighten them later.

STEP 17 Checking the smooth rods: X-end

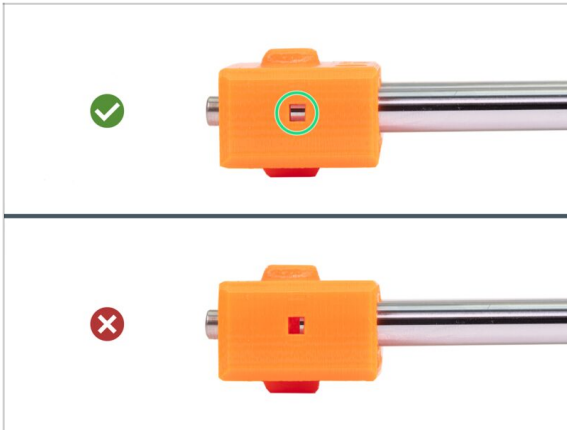

Look sideways on the MINI-X-end into the inspection hole and **ensure that the smooth rod is inserted all the way in the plastic part.**

Some early units may be without inspection holes.

If the rod is not fully visible in the groove, try using more force to push MINI-X-end on the rod. **Do not use a hammer or similar tools to push the plastic part!**

Turn the X-axis and use the same procedure for the second smooth rod.

STEP 18 X-carriage: parts preparation



For the following steps, please prepare:

MINI-x-carriage (1x)

M3n nut (1x)

M3nS nut(1x)

STEP 19 Assembling the X-carriage

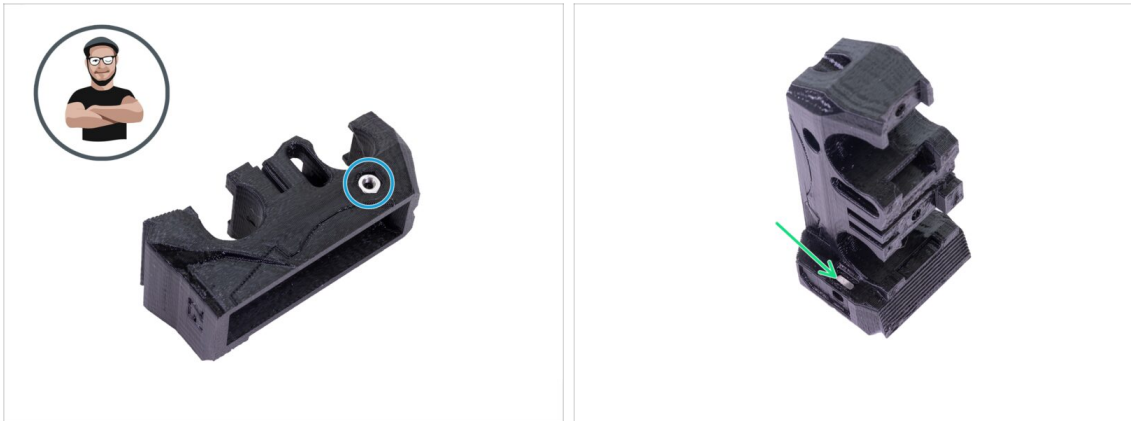

- ◆ Insert the M3n nut into the MINI-X-carriage from the side.
- i Use the screw pulling technique.
- ◆ Locate the hole on the opposite side of the part and insert the M3nS nut all the way down into the hole.

STEP 20 Mounting the X-carriage



- ◆ Align both bearings with the markings facing you.
- ◆ Place the X-axis with the screw heads in the MINI-Z-carriage facing you.
- ◆ Take the MINI-X-carriage and place it above the bearings. Make sure the longest side of the part is on the left side.
- ◆ Align the cutouts in the part against the bearings.
- ◆ Push the MINI-X-carriage onto the bearings
- ◆ Ensure the bearings are properly seated and they are centered in the X-carriage.

STEP 21 X-axis motor: parts preparation

For the following steps, please prepare:

- X-axis motor (1x)
- Pulley T16-2GT (1x)
- X-axis belt 2GT 561 mm (1x)
- M3x12 screw (2x)

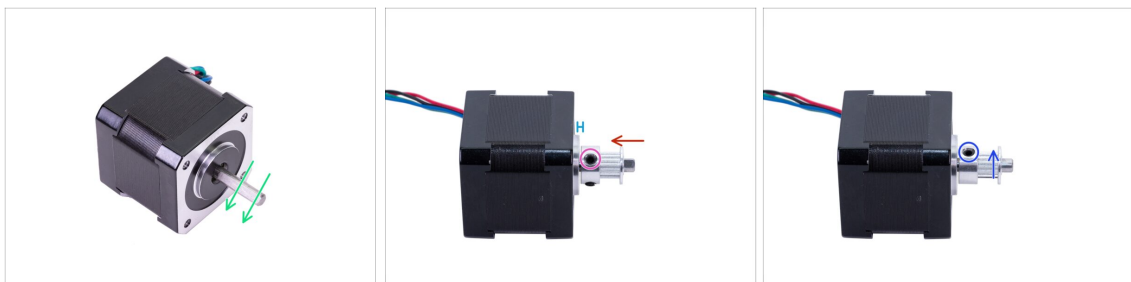
STEP 22 Assembling the X-axis motor

- There is a flat part on the motor shaft. Rotate it similarly to the first picture. See the direction of the arrows.
- Place the pulley T16-2GT on the X-axis motor shaft as shown in the picture.
- Don't press the pulley against the motor. Leave a gap of 0.7 - 1 mm between both parts.
- ⓘ There is mentioned a 2mm gap in the earlier version of the manual. Please, **use the value mentioned in the current manual.**
- One of the screws must be facing directly against the pad (flat part) on the shaft. Tighten the first screw gently but firm.
- Turn the shaft and slightly tighten the second screw.
- ⚠ **Ensure you have the correct orientation of the pulley on the shaft. It can be placed both ways, but only one is correct.**

STEP 23 Mounting the X-axis motor

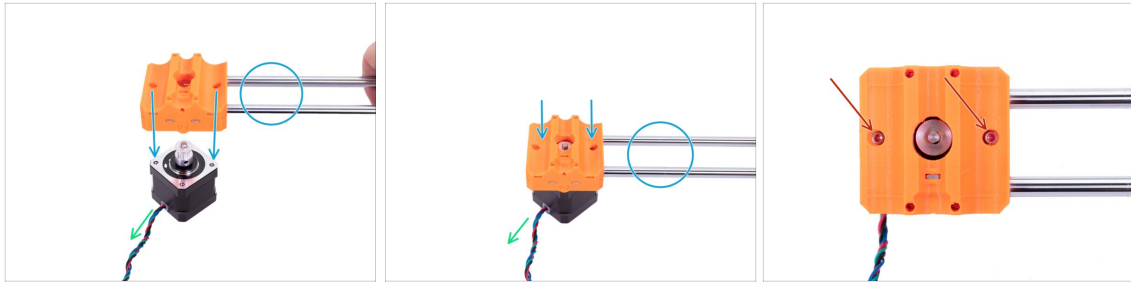

- Place the X-axis motor like in the picture. See the cable direction.
- Put the X-axis on the X-axis motor and align the holes on both parts. Make sure that smooth rods are facing to the right.
- Fix both parts together with two M3x12 screws.

STEP 24 X-axis belt guidance

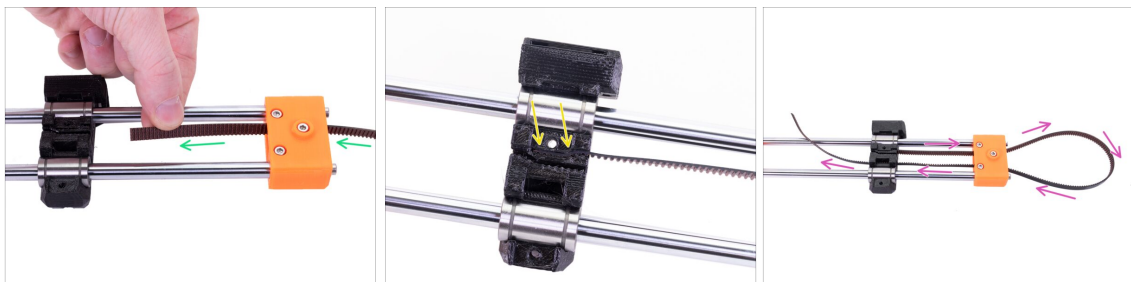

- Place the X-axis like in the picture.
- Take the X-axis belt and guide it in the upper position around the pulley in the X-end.
- Insert the belt along the entire length of the upper groove in the X-carriage.
- Take the second end of the belt and guide it around the pulley in the X-end and through the hole in X-carriage.

STEP 25 X-axis belt guidance

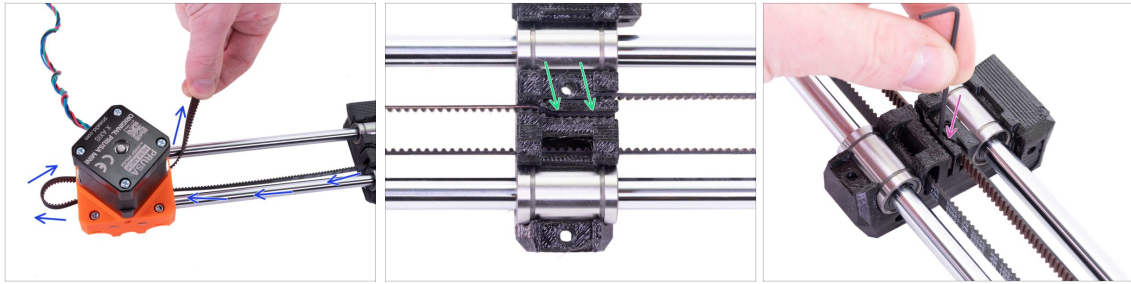

- ◆ Guide the belt around the X-axis motor pulley.
- ◆ Insert the end of the belt into the lower groove on the X-carriage.
- ◆ Secure both ends of the belts by squeezing them into the groove with the 1.5mm Allen key.
- ⓘ The belt may seem too loose. **We will adjust the correct tension later.**

STEP 26 X-axis assembly: reward yourself!



- ◆ You just finished the **X-axis assembly**. Now, it's time to reward yourself.
- ◆ Eat the first part of the second row.

STEP 27 Z-carriage: parts preparation

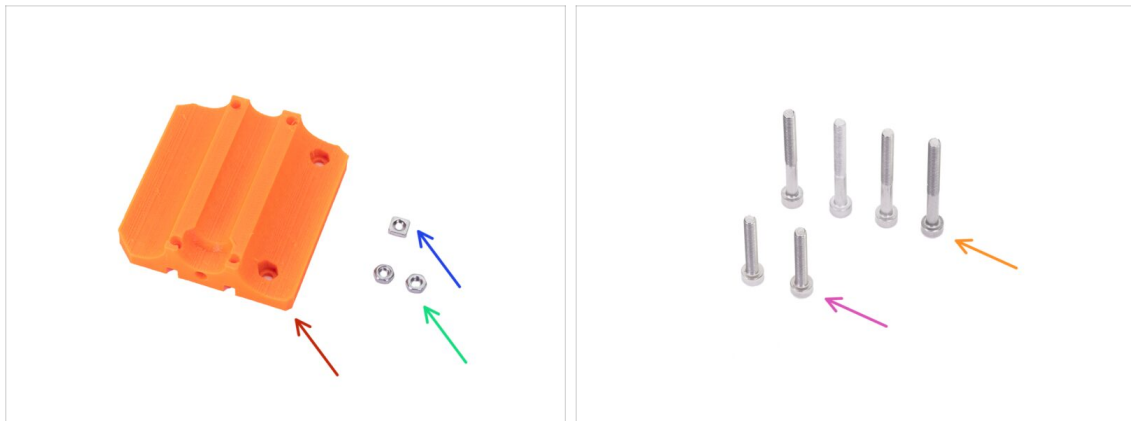

● For the following steps, please prepare:

ⓘ Fasteners needed for the following steps are in the **Extruder** package. Please, prepare this bag.

- MINI-Z-carriage-rear (1x)
- M3n nut (2x)
- M3nS nut (1x)
- M3x30 screw (4x)
- M3x20 screw (2x)

STEP 28 Preparing the Z-carriage

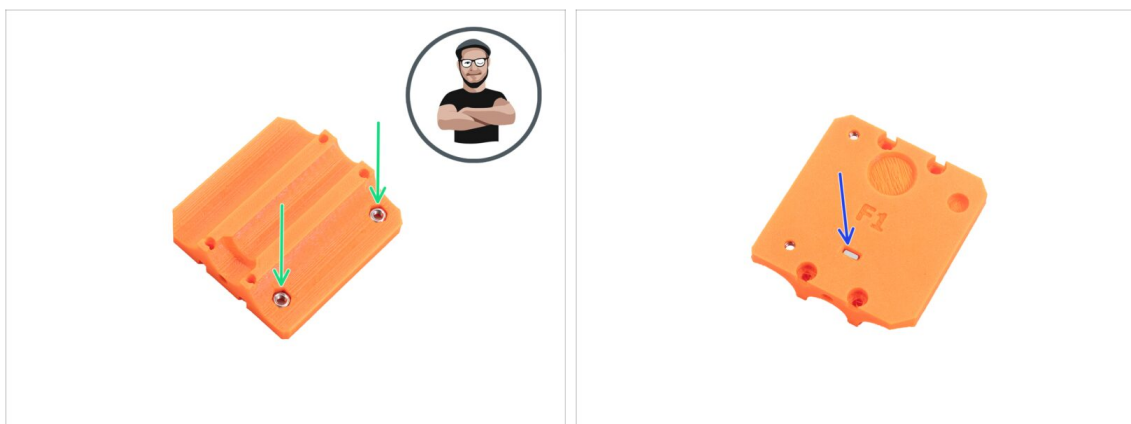

● Insert two M3n nuts in the MINI-Z-carriage. **Make sure the nuts are properly seated** and don't fall out.

ⓘ Use the screw pulling technique.

● Insert the M3nS nut into the hole on the bottom side.

STEP 29 Mounting the X-axis

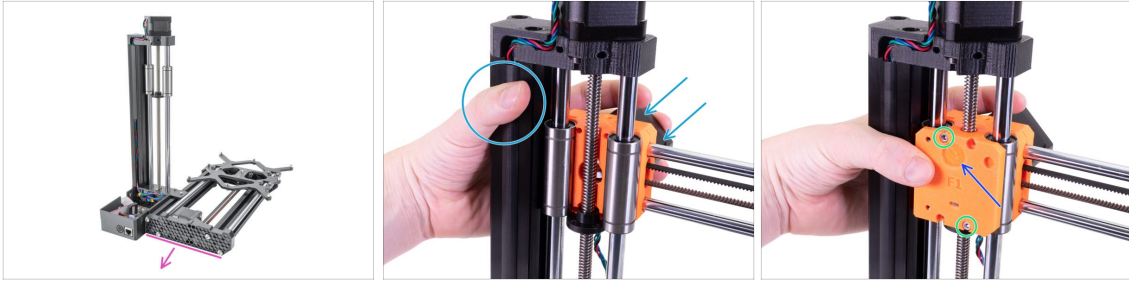

- ◆ Turn the assembly so that the rear side is facing you.
- ◆ Place the X-axis on the Z-axis bearings and trapezoidal nut. Hold it by hand all the time during installation.
- ◆ Place the MINI-Z-carriage-rear on the bearings. See the round recess of the part for better orientation.
- ◆ Secure it with two M3x30 screws diagonally. You can release your hand from the assembly now.

STEP 30 Mounting the X-axis

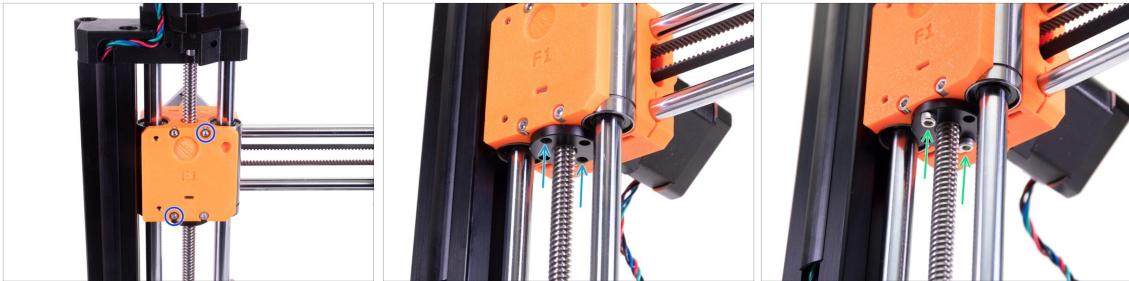

- ◆ Insert and tighten two M3x30 screws into the remaining holes.
 - ◆ Look from below and align two holes in the trapezoidal nut against the holes in the plastic parts.
 - ◆ Secure the trapezoidal nut to the X-axis with two M3x20 screws.
- ⚠ Do not overtighten the screws! Otherwise, it can cause issues during printing. Tighten gently, but firmly.**

STEP 31 Plastic cover: parts preparation

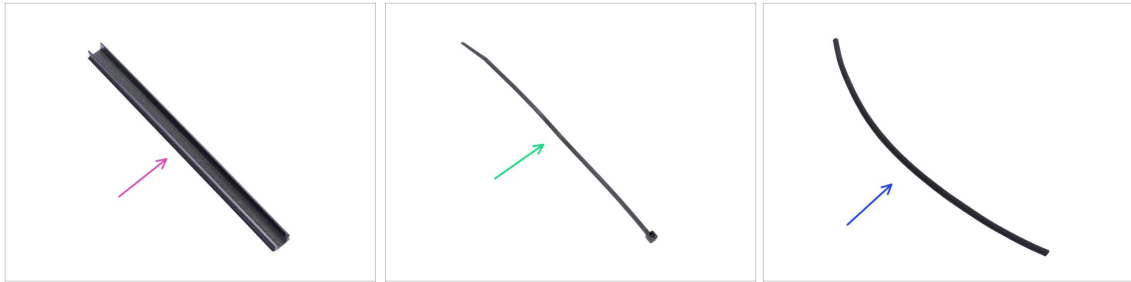

◆ For the following steps, please prepare:

- ◆ Plastic cover (1x)
- ◆ Zip tie (1x)
- ◆ Textile sleeve 5x300 mm (1x)

STEP 32 Guiding the X-axis motor cable

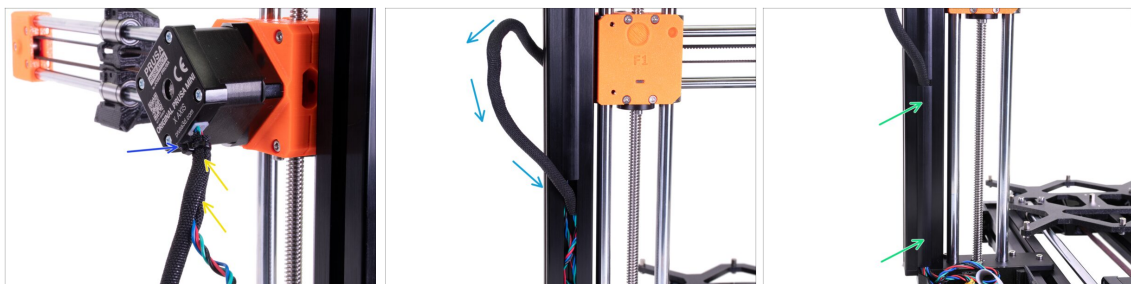

- ◆ Wrap the textile sleeve around the X-axis motor cable.
- ◆ Secure the textile sleeve with the zip tie a few millimeters from the end. Do not overtighten the zip tie, you might damage the cable.
- ⓘ Cut the remaining part of the zip tie using pliers as closest to its head as possible.
- ◆ Wrap the entire textile sleeve around the X-axis motor cable and guide it into the extrusion.
- ◆ Cover the extrusion with the plastic cover.

STEP 33 Connecting the X-axis motor



- Connect the X-axis motor cable to the Buddy control board. Use the second slot from the left.

STEP 34 X-axis belt tensioning

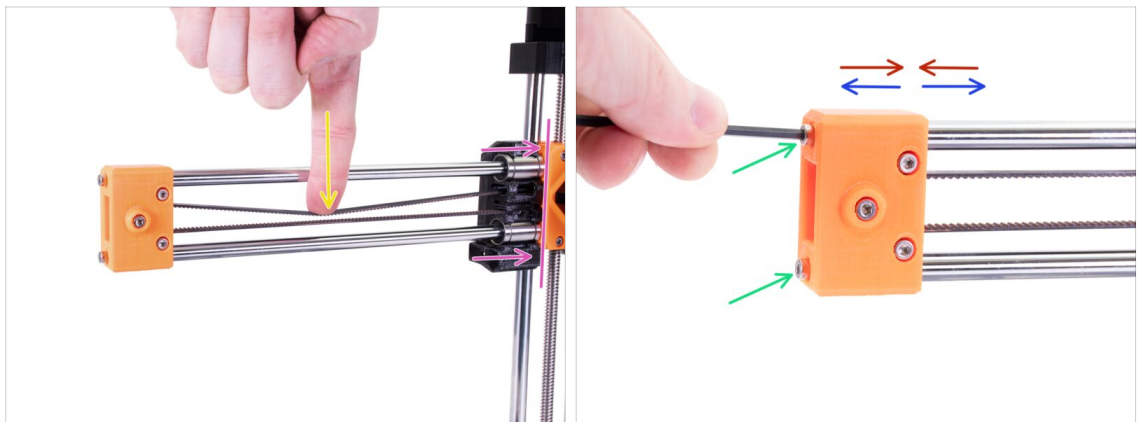

- Move the X-carriage all the way to the Z-carriage.
- Using a finger on your left hand push the belt down in the center of the X-axis. Some force should be needed for bending the belt, BUT don't try to overstretch the belt as you might damage the printer.
- Adjust it by releasing or tightening both screws on the X-end.
 - **Release the screws**, bring the X-end closer to rods and thus decrease the overall tension.
 - **Tighten the screws**, X-end will move apart, the overall tension will increase.

STEP 35 Belt tension check

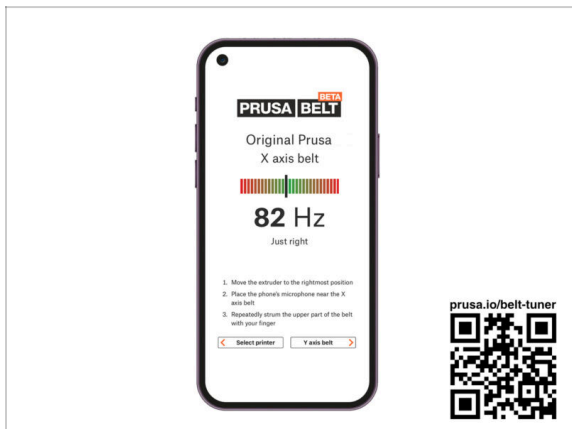

- i This step is recommended, but optional. If you don't have a phone at your disposal, continue to the next step. You can do this check later on.
- ◆ To verify or fine-tune the X or Y-axis belt tension on your printer, visit prusa.io/belt-tuner and open up the webpage on your mobile device. Or using your phone, scan the QR code in the picture.
- ◆ Follow the on-screen instructions to fine-tune the belt tension.
- i The belt tuner app was tested on multiple phones and should work across all most common phone manufacturers. However, in some rare cases it might not work as expected. Please state your brand and model in the comments below the step.

STEP 36 Securing the X-end

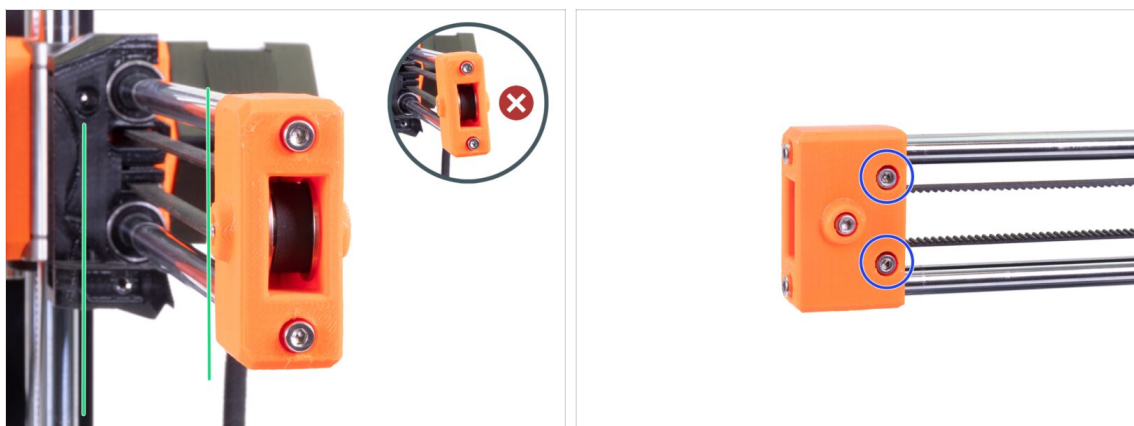

- ◆ Look at the X-axis from the side. Align the X-end parallel to the Z-axis smooth rods by twisting the plastic part. **Do not use too much force** to twist, you may damage the X-axis.
- ◆ Securing the X-end by tightening both screws on the front side of the plastic part.
- ⚠ After tightening, **check once more the X-end is parallel with the Z-axis.**

STEP 37 Extruder motor: parts preparation



◆ For the following steps, please prepare:

◆ Extruder motor (1x)

◆ Motor pinion (1x)

STEP 38 Assembling the Extruder motor

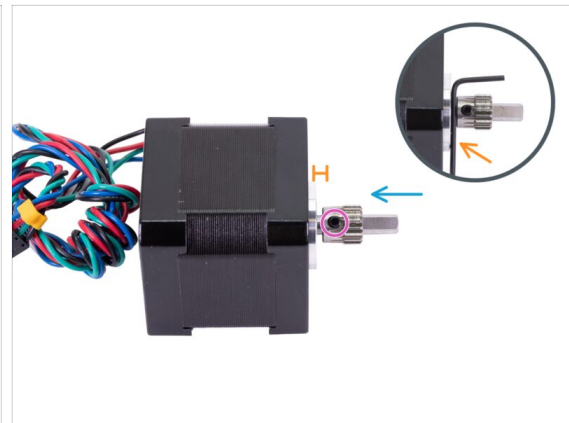

◆ There is a flat part on the motor shaft. Rotate it similarly to the first picture. See the direction of the arrows.

◆ Place the Extruder pinion on the Extruder motor shaft as shown in the picture.

◆ Don't press the pinion against the motor. Leave a 1.5 millimeters gap between both parts. You can use the 1.5mm Allen key to set the gap.

◆ The set screw must be facing directly against the pad (flat part) on the shaft. Tighten the screw with the longest part of the Allen key. Be careful, not to strip the screw.

⚠ **Ensure you have the correct orientation of the pulley on the shaft. It can be placed both ways, but only one is correct.**

STEP 39 Extruder-front: parts preparation

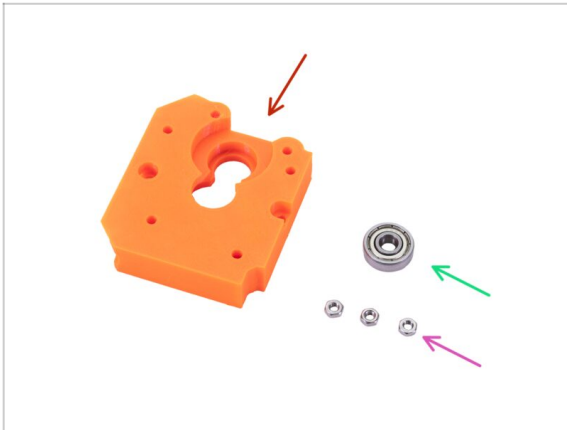

◆ For the following steps, please prepare:

◆ MINI-Extruder-front (1x)

◆ M3n nut (3x)

◆ Bearing 625 2Z (1x)

STEP 40 Assembling the Extruder-front

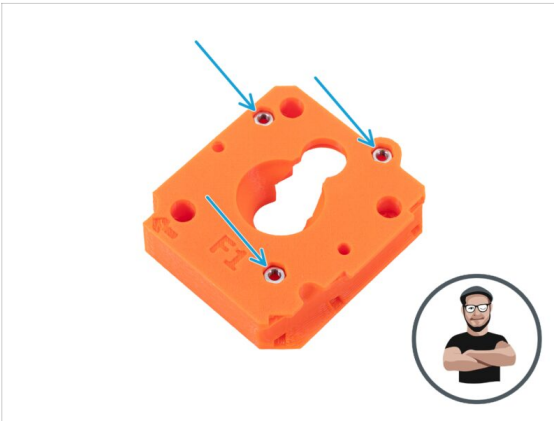

◆ Place the MINI-Extruder-front like in the picture and insert three M3n nuts to the holes.

ⓘ Use the screw pulling technique.

◆ Turn the part upside down and insert the bearing into the part.

STEP 41 Extruder-rear: parts preparation

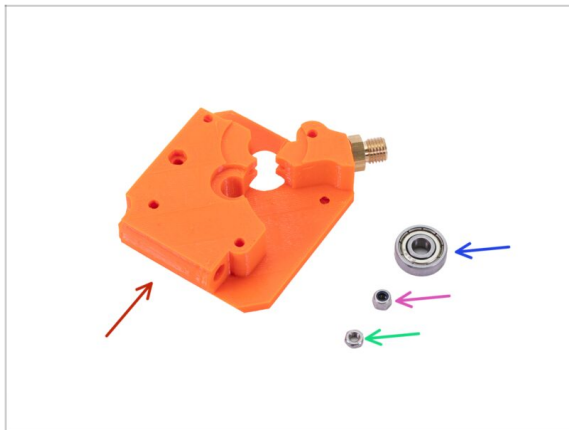

◆ For the following steps, please prepare:

◆ MINI-Extruder-rear (1x)

◆ M3n nut (1x)

◆ M3nN nyloc nut (1x)

◆ Bearing 625 2Z (1x)

STEP 42 Assembling the Extruder-rear

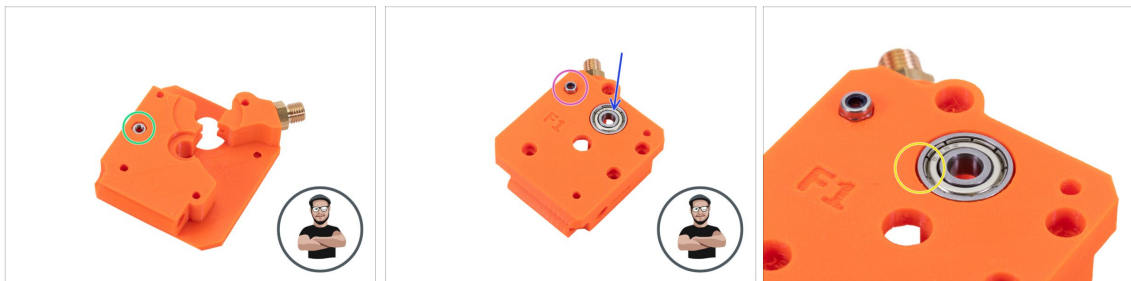

◆ Place the MINI-Extruder-rear like in the picture and insert the M3n nut into the hole.

ⓘ Use the screw pulling technique.

◆ Turn the part upside down.

◆ Insert the M3nN nyloc nut into the MINI-Extruder-rear from the opposite side.

ⓘ Use the screw pulling technique.

◆ Insert the bearing into the part.

◆ Make sure the bearing is aligned with the top surface of the printed part.

STEP 43 Extruder-idler: parts preparation

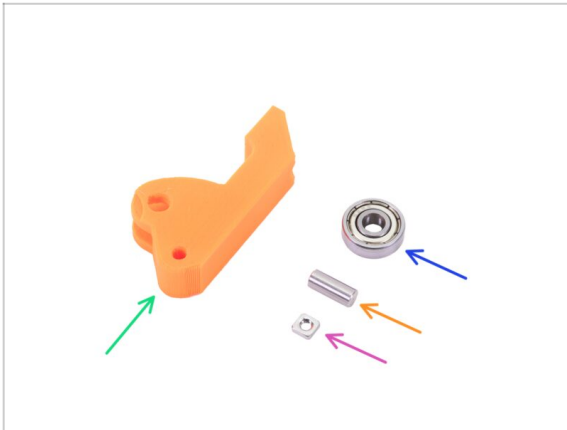

◆ For the following steps, please prepare:

- ◆ MINI-Extruder-idler (1x)
- ◆ Bearing 625 2Z (1x)
- ◆ Shaft 5x12 mm (1x)
- ◆ M3nS nut (1x)

STEP 44 Assembling the Extruder-idler



- ◆ Insert the M3nS nut into the MINI-Extruder-idler.
- ◆ Place the bearing into the part.
- ◆ Align the holes and secure the bearing with shaft. Make sure the shaft is aligned with the surface of the plastic part.

STEP 45 Extruder assembly: parts preparation



◆ For the following steps, please prepare:

- ◆ Spring 5x15 mm (1x)
- ◆ M3x12 screw (3x)
- ◆ M3x25 screw (4x)
- ◆ M3x40 screw (1x)
- ◆ Filament Spur (1x)
- ◆ PTFE tube 4x2x150 mm (1x)

STEP 46 Assembling the Extruder

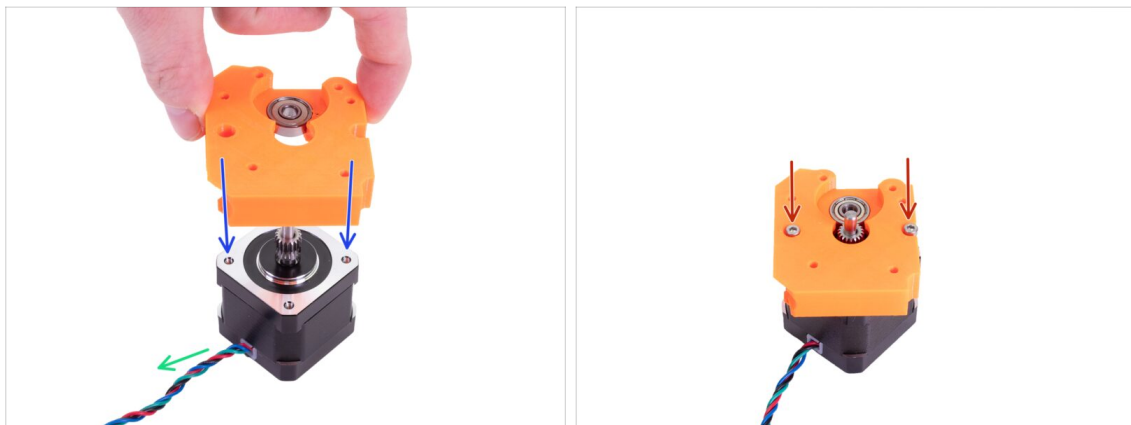

- ◆ Place the Extruder motor like in the picture. See the cable direction.
- ◆ Put the MINI-Extruder-front on the motor and align the holes on both parts.
- ◆ Secure both parts with two M3x12 screws.

STEP 47 Assembling the Extruder



- ◆ Place the filament spur into the bearing. The longer part with the jagged groove must face up. See the picture.
- ◆ Make sure that both gears fit together.
- ◆ Rotate with one pulley to ensure the second is moving as well.

STEP 48 Assembling the Extruder

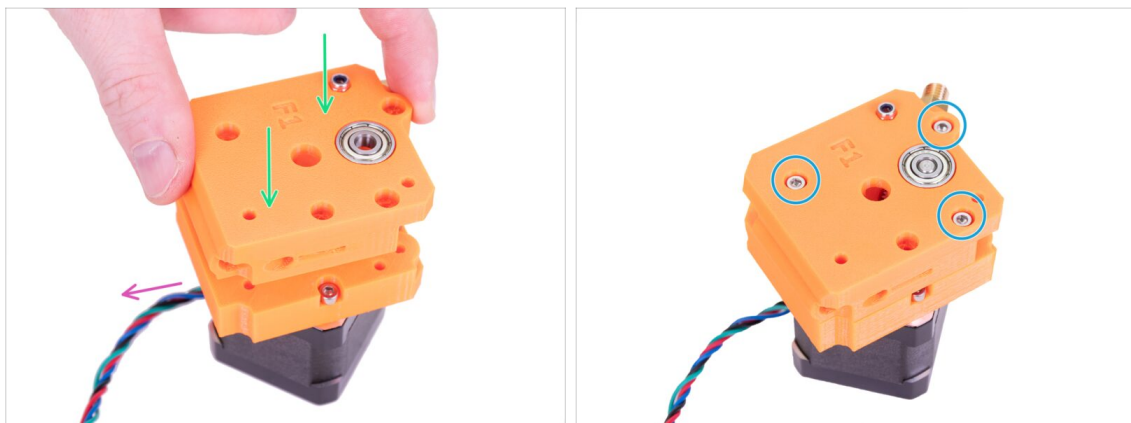

- ◆ Place the MINI-Extruder-rear on the MINI-Extruder-front. See the orientation of both parts.
- ◆ Make sure the cable from the motor is oriented in the same way as in the picture.
- ◆ Secure parts together with three M3x25 screws.

STEP 49 Mounting the MINI-Extruder-idler



- Insert the assembled MINI-Extruder-idler to the Extruder.
- Align the holes on both parts and secure it with the M3x25 screw. Do not overtighten. Make sure the idler can move freely.
- Place the spring on the M3x40 screw.
- Hold the extruder and idler with your hand.
- Insert and tighten the screw with the spring into the Extruder. Stop tightening when the screw head is aligned with the edge of the plastic part.

STEP 50 Inserting the PTFE tube



- It's recommended to mark the distance of 2.5 cm (0.98 inches) from the end of the PTFE tube before the insertion to the extruder. Both ends are symmetrical.
- Locate the hole for the PTFE tube on the side of the extruder assembly and insert the marked end of the tube all the way to the extruder. Check the correct insertion according to the marking on the tube.
- Secure the tube with the M3x12 screw.

STEP 51 Inspection-door: parts preparation

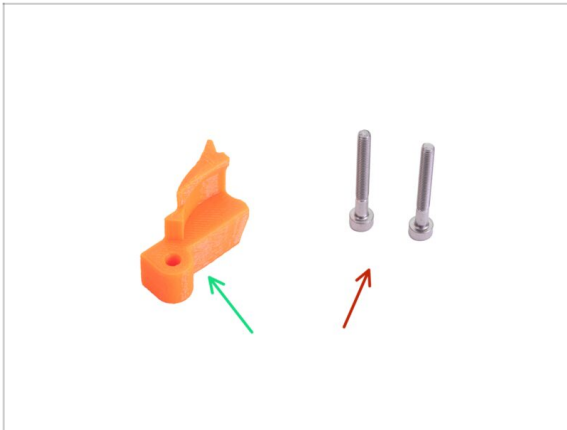

- ◆ For the following steps, please prepare:
- ◆ MINI-Inspection-door (1x)
- ◆ M3x25 screw (2x)

STEP 52 Mounting the Extruder

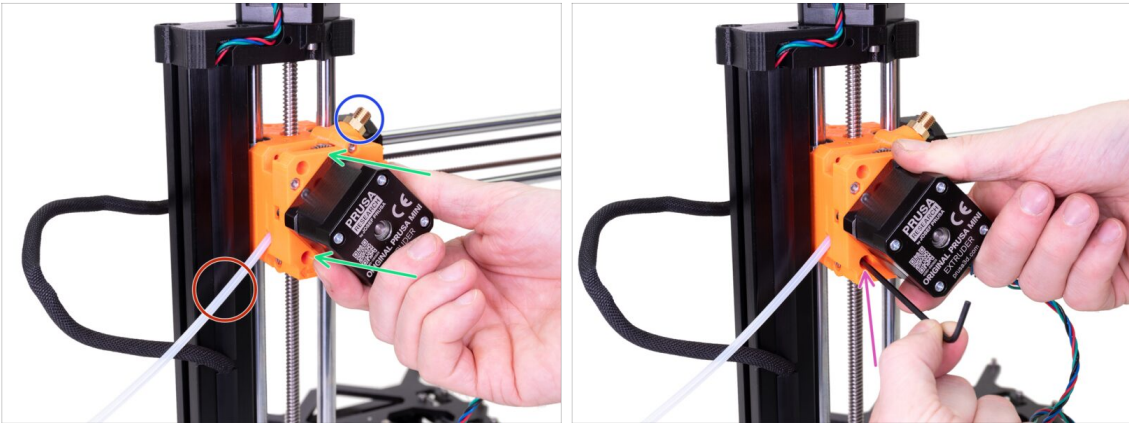

- ◆ Place the extruder on the Z-carriage. Make sure the orientation is correct:
 - ◆ The PTFE tube is facing to the left.
 - ◆ The brass fitting is on the top right.
- ◆ Secure it with the M3x25 screw in the lower hole.

STEP 53 Mounting the Extruder

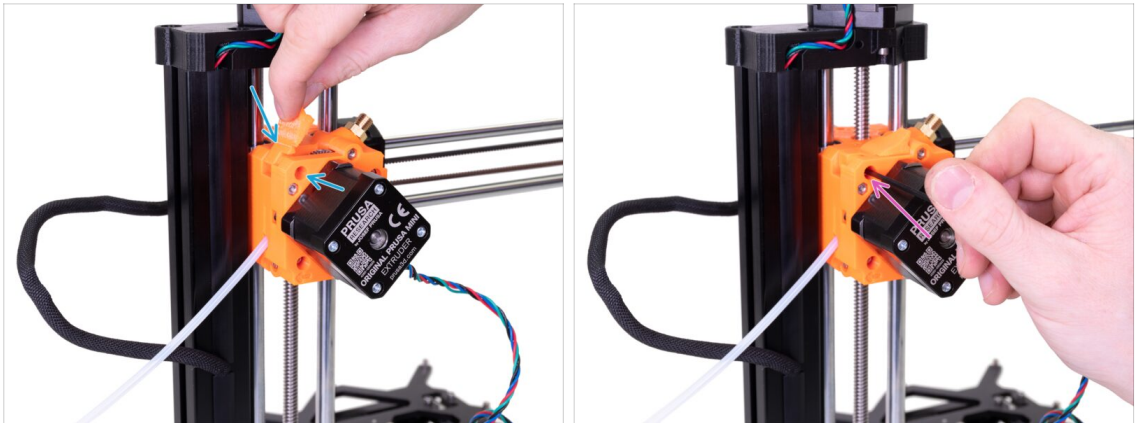

- Place the MINI-Inspection-door to the extruder and align the holes.
- Secure it with the M3x25 screw. Do not overtighten. Make sure the MINI-Inspection-door can move freely.
- Leave the Extruder motor cable to hang freely for now.

STEP 54 Extruder assembly: reward yourself!



- You just finished the **Extruder assembly**. Reward yourself, it was a little difficult.
- Eat the second part of the second row.

STEP 55 X-axis is finished!



- ◆ Compare your assembly with the picture.
- ◆ Now it's time to the next chapter: **4. Printhead & Heatbed assembly**

4. Print head & Heatbed assembly



STEP 1 Tools necessary for this chapter

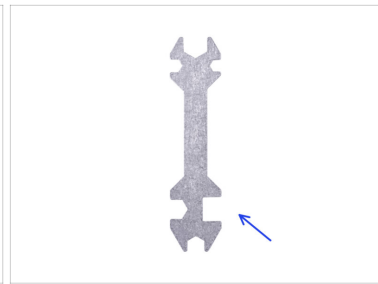
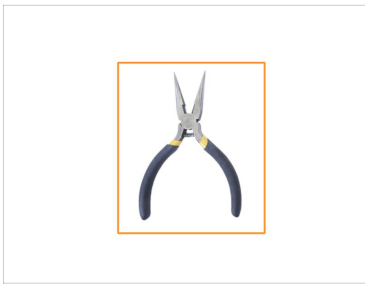
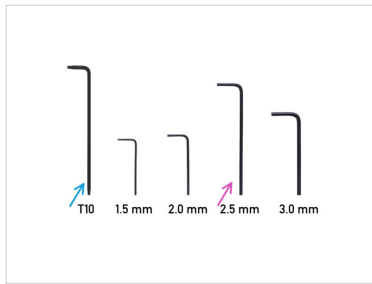

🛠️ **For this chapter please prepare:**

- 🔩 2.5mm Allen key
- 🔩 T10 Torx key
- 🔧 Needle-nose pliers
- 🔧 Universal wrench

STEP 2 Hotend & Print fan: parts preparation



📄 **All the printed parts and fasteners needed for this chapter are included in the box:**
Print head & Heatbed

🛠️ **For the following steps, please prepare:**

- 🟢 MINI Hotend assembly (1x)
- 🔩 Print fan (1x)
- 🔩 M3x20 screw (3x)

STEP 3 Mounting the hotend

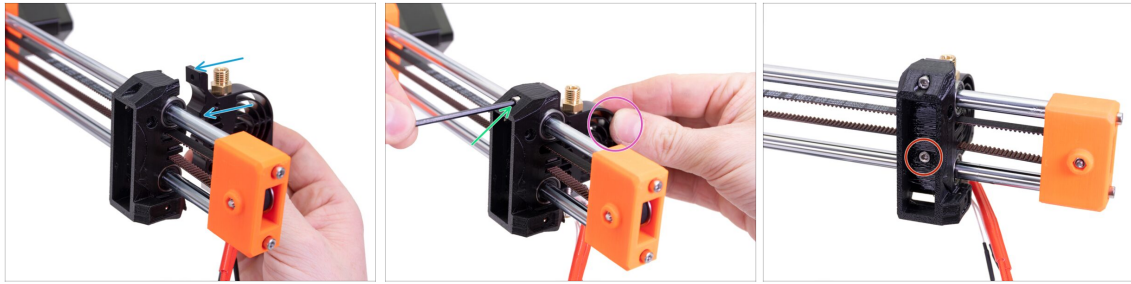

- Place the hotend assembly on the X-carriage.
- Hold the heatsink with your hand.
- Use the other hand to secure the heatsink with the upper M3x20 screw.
- Insert and tighten the M3x20 screw into the lower hole.

STEP 4 Mounting the print fan

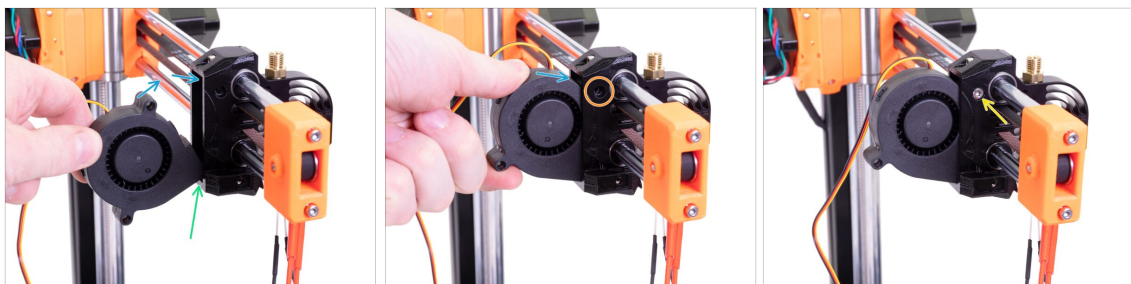

- Insert the edge of the fan on the bottom edge of the X-carriage pocket. **Make sure the sticker on the fan is on the other side.**
- Insert the fan into the x-carriage.
- Align the screw hole in the fan with the hole in the X-carriage.
- Insert and tighten the M3x20 screw.

STEP 5 Hotend fan: parts preparation



◆ For the following steps, please prepare:

- ◆ Hotend fan (1x)
- ◆ M3x20 screw (1x)
- ◆ MINI-fan-spacer (1x)

STEP 6 Assembling the hotend fan

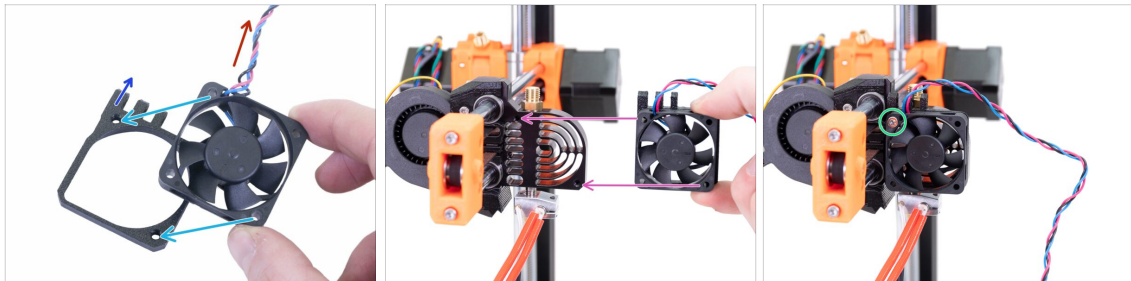

- ◆ Place the hotend fan on the MINI-fan-spacer. Align the holes against each other.
- ◆ Make sure the sticker on the fan is on the bottom side.
- ◆ The fan cable must be facing the upper left.
- ◆ The "teeth" for the MINI-fan-spacer-clip must be oriented upwards to the left.
- ◆ Place the hotend fan with MINI-fan-spacer on the heatsink. Align the holes for the screws on the fan with the holes on the heatsink.
- ◆ Secure the hotend fan and the spacer with the M3x20 screw in the upper left hole.

STEP 7 Minda-holder: parts preparation



◆ For the following steps, please prepare:

- ◆ MINI-minda-holder (1x)
- ◆ M3nN nyloc nut (1x)
- ◆ M3x12 screw (1x)
- ◆ M3x20 screw (1x)

STEP 8 Assembling the Minda-holder



◆ Insert the M3nN nut all the way into the MINI-minda-holder.

STEP 9 Mounting the MINI-minda-holder

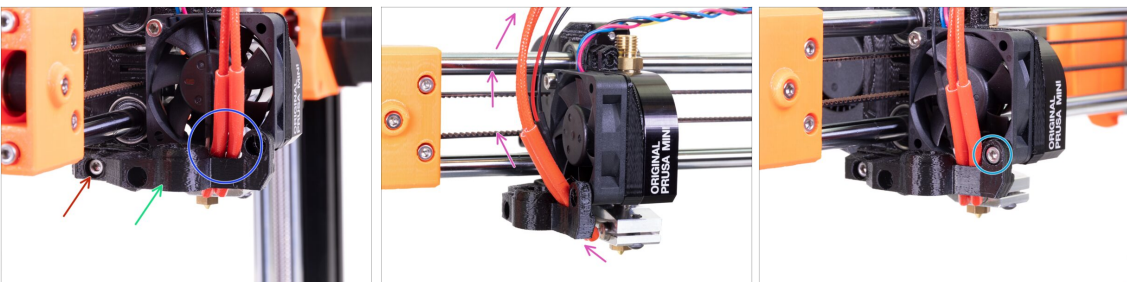

- ◆ Place the MINI-minda-holder on the hotend fan.
- ◆ Secure with the M3x12 screw.
- ◆ Make sure the **hotend cables are not pinched**.
- ◆ Guide the hotend cables as shown in the picture.
- ◆ Secure the MINI-minda-holder with the M3x20 screw.

STEP 10 SuperPINDA sensor: parts preparation



◆ For the following steps, please prepare:

◆ SuperPINDA sensor (1x)

◆ M3x12 screw (1x)

STEP 11 Installing the SuperPINDA sensor

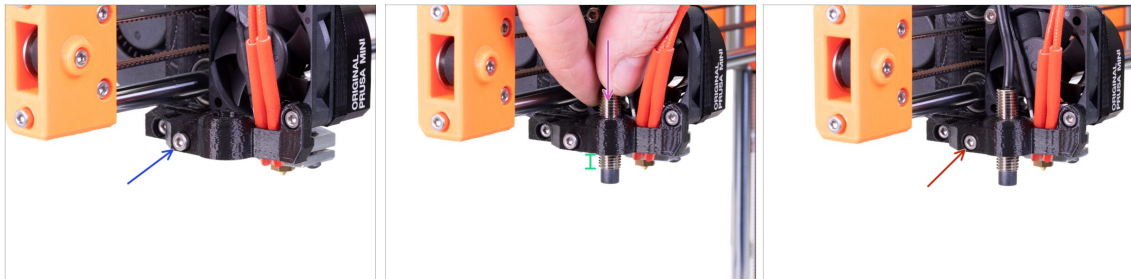

- ◆ Screw in the M3x12 screw by 2-3 threads. We'll tighten it later.
- ◆ Insert the SuperPINDA sensor into the MINI-minda-holder.
- ◆ Adjust the SuperPINDA sensor position, there should be about 4-5 threads below the MINI-minda-holder. *This a temporary position for now. We will set the proper one later on.*
- ◆ Tighten the screw on the MINI-minda-holder. **Do not use excessive force, you can damage the MINI-minda-holder!**

STEP 12 Fan-spacer-clip: parts preparation

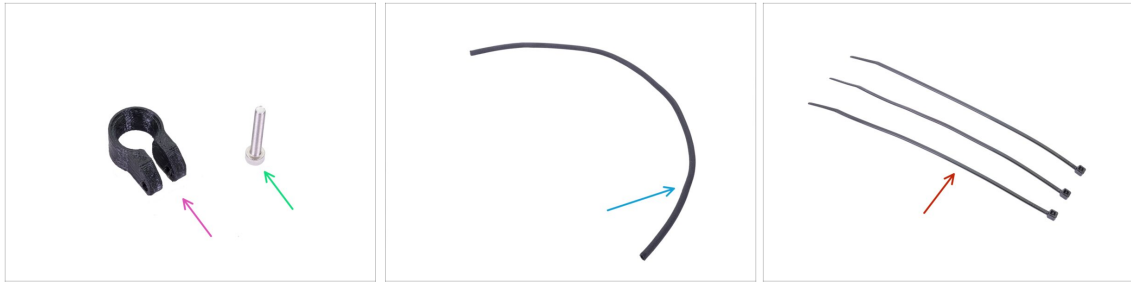

For the following steps, please prepare:

MINI-fan-spacer-clip (1x)

M3x20 screw (1x)

Textile sleeve 8x700 mm (1x)

i There are two textile sleeves with different lengths in the package for this chapter. Please, **take the longer one**.

Zip tie (3x)

STEP 13 Guiding the hotend cables

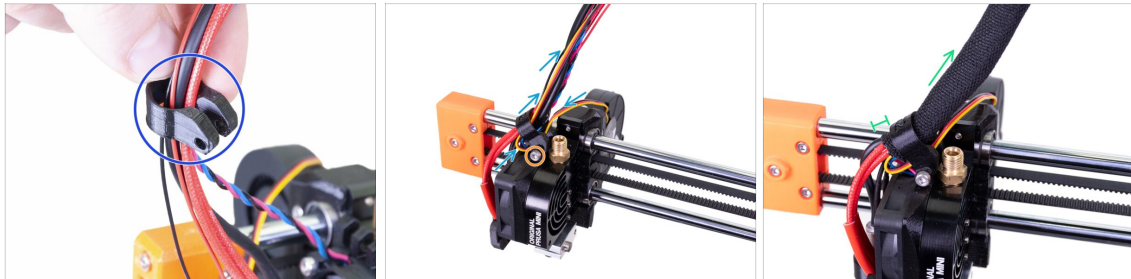

Push all the cables from the print head into the MINI-fan-spacer-clip. Orient the clip as shown in the picture, the beveled side is up.

Guide the print fan cable through MINI-fan-spacer-clip groove. Create a loop under the clip and guide the cable together with the bundle.

Slide down the MINI-fan-spacer-clip and mount it on the spacer with the M3x20 screw. Tighten the screw, then release it slightly by 1/4 of turn (90 °). No nut is needed here.

⚠ The MINI-fan-spacer-clip must move freely.

Merge all cables leading from the hotend together and guide them up.

Wrap the textile sleeve around the cable bundle and slide it into the MINI-fan-spacer-clip so that it extends over the 2-5mm textile sleeve from the other side. Guide the textile sleeve to the extruder.

STEP 14 Guiding the hotend cables

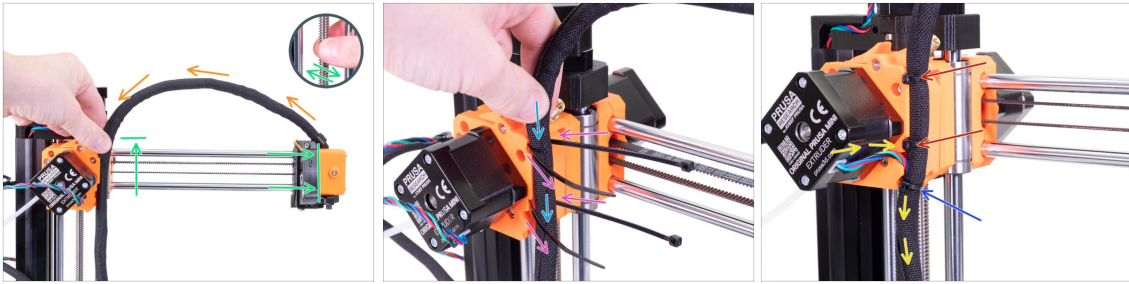

- ◆ Start by rotating the lead screw with your fingers until the X-axis is in the highest position. And move the print head all the way to the right and ensure it is touching the printed part.
- ◆ Bend the cable bundle slightly and guide it to the extruder.
- ◆ Thread two zip ties through the holes in the extruder.
- ◆ Place the cable bundle on the extruder as you see in the picture.
- ◆ Secure the cable bundle by tightening both zip ties.
- ◆ Insert the motor cable into the cable bundle.
- ◆ Insert and tighten the third zip tie.
- ⓘ Cut the remaining part of each zip tie using pliers as closest to its head as possible.

STEP 15 Guiding the hotend cables

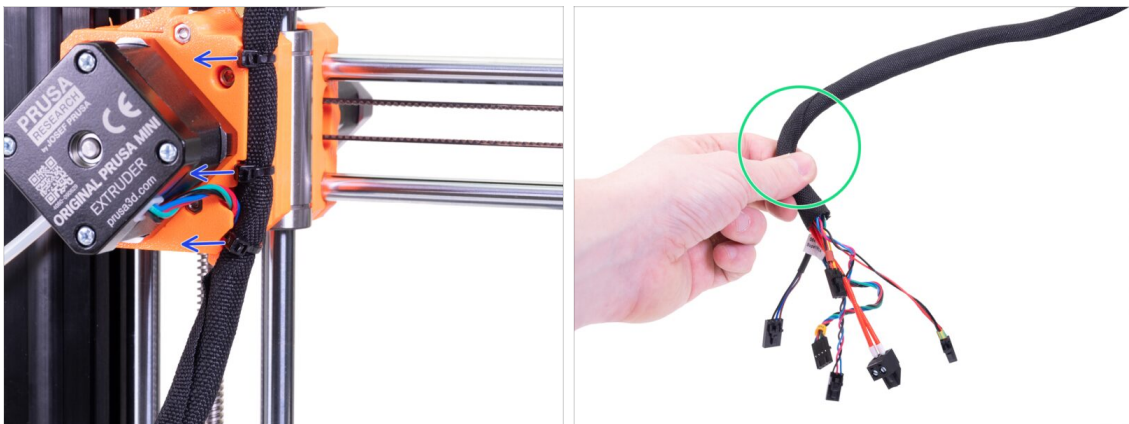

- ◆ Rotate the zip tie's head to the left.
- ⚠ **Make sure you have rotated the heads to the left, otherwise you might have issues during the print!**
- ◆ Slightly twist the sleeve (not the cables inside). The sleeve will evenly wrap all around the cable bundle.

STEP 16 PTFE tube - parts preparation

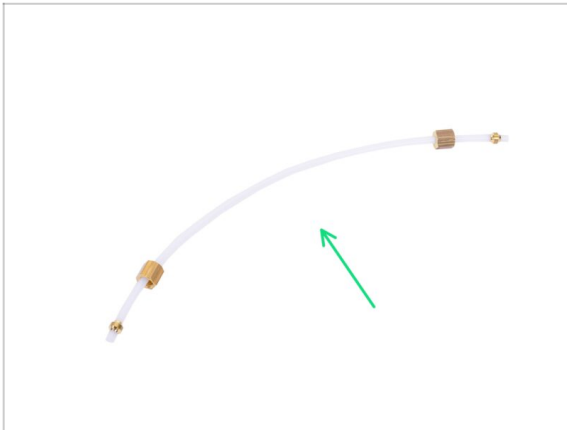

- ◆ For the following steps, please prepare:
- ◆ Print head PTFE tube 4x2x275 mm (1x)

STEP 17 Mounting the PTFE tube

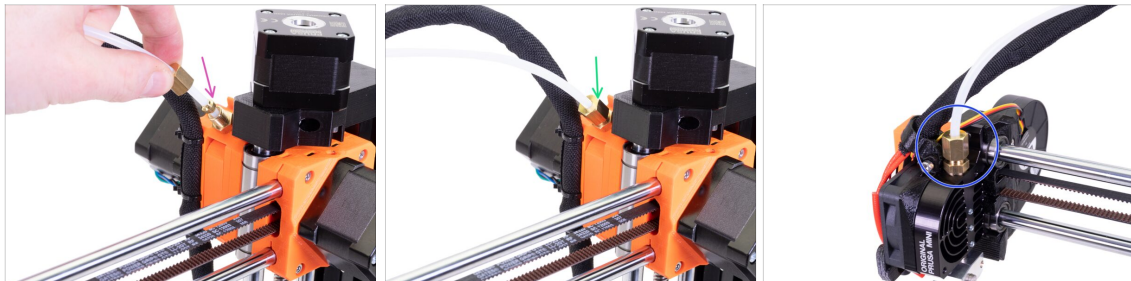

- ◆ Take the end of the PTFE tube and insert it to the brass fitting on the extruder. Both ends of the tube are symmetrical.
- ◆ Slide the brass nut down and tighten it with the universal wrench.
- ◆ Use the same procedure to mount the other end of the PTFE tube on the print head.

STEP 18 Print head: reward yourself!



- You just finished the **Print head assembly**. It was an easy part of the chapter.
- ◆ Eat the first part of the third row.

STEP 19 Heatbed: parts preparation

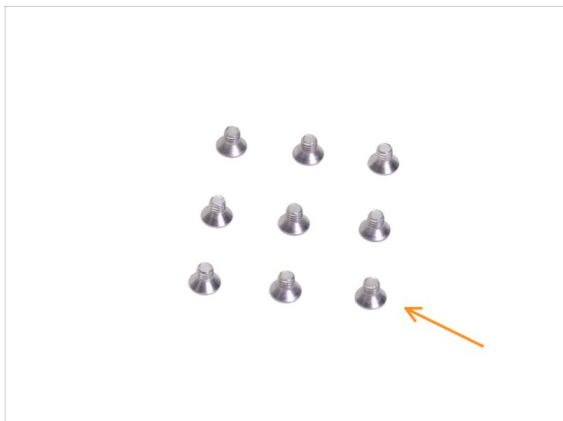
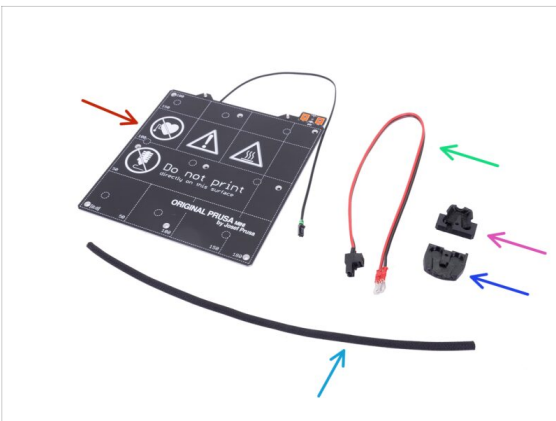

● For the following steps, please prepare:

- Heatbed MINI+ (1x)
- ◆ Heatbed cable (1x)
- ◆ MINI-heatbed-cable-cover-top (1x)
- ◆ MINI-heatbed-cable-cover-bottom (1x)
- ◆ Textile sleeve 5x350 mm (1x)
- ◆ M3x4b Countersunk screw (9x)

ⓘ The list continues in the next step...

STEP 20 Heatbed: parts preparation



● For the following steps, please prepare:

- M3x12 screw (1x)
- M3x8 screw (2x)
- M3nN nyloc nut (3x)

STEP 21 Assembling the heatbed

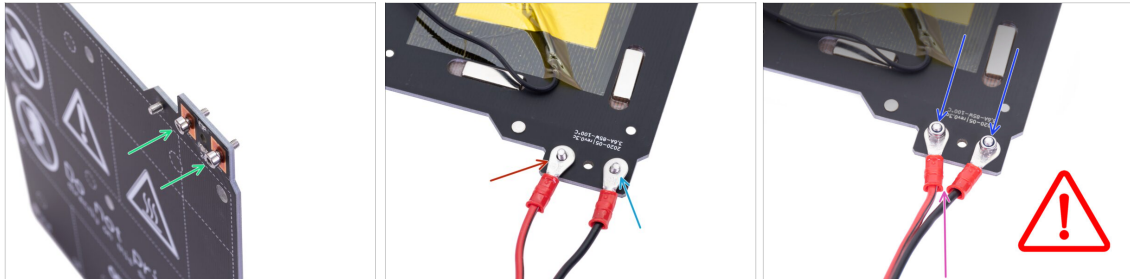

- Insert two M3x8 screws to the heatbed. Screw heads must be on the top surface of the heatbed.
- Turn the heatbed bottom up and place it like in the picture.
- Place the red wire (+) on the left screw.
- Place the black wire (-) on the right screw.
- Attach two M3nN nuts onto both screws and tighten them **firmly**.
- The cable cover, which will be applied later requires the connectors to be slightly inclined towards each other. Hold them in the position as seen in the picture while tightening, but leave a small gap between them. Ensure the cable lugs can't move after tightening.

⚠ **Make sure the cables are connected properly and the screws are tightened fully.** Improper wiring or loose connection to the heatbed can fatally damage the electronics.

STEP 22 Guiding the heatbed cables

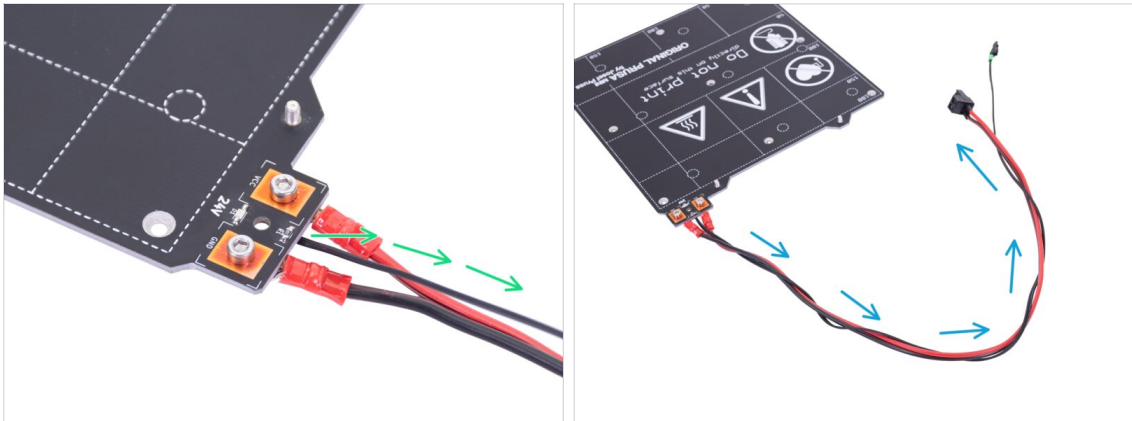

- ◆ Guide the black thermistor cable between the heatbed cables.
- ◆ Wrap the thermistor cable a few times around the heatbed cables (see the photo).

STEP 23 Covering the heatbed cables



- ◆ Insert the M3nN nut into the MINI-heatbed-cable-cover-bottom.
- ◆ Place the MINI-heatbed-cable-cover-bottom on the bottom of the heatbed cable connectors.
- ◆ Make sure the connectors fit properly into the cover.
- ◆ Wrap the textile sleeve around the heatbed cable bundle. Slide the sleeve into the cover as far as possible.

STEP 24 Covering the heatbed cables

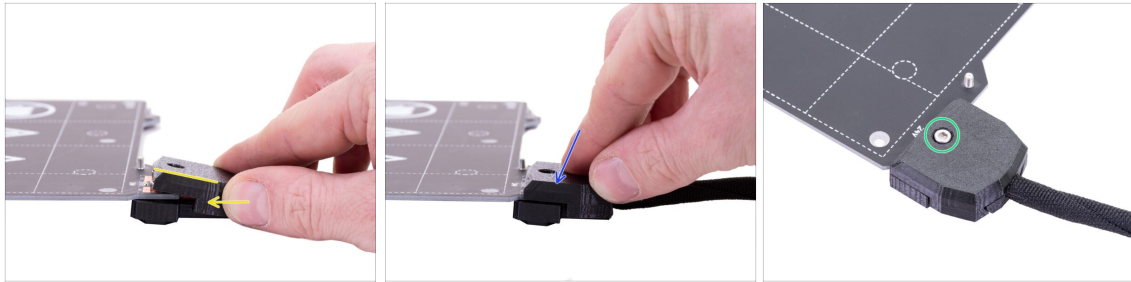

- ◆ Slightly tilt the MINI-heatbed-cable-cover-top and slide it over the screw heads on the connectors.
- ◆ Push the cover to fit properly the bottom part of the cover.
- ◆ Secure it with the M3x12 screw.

STEP 25 Covering the heatbed cables

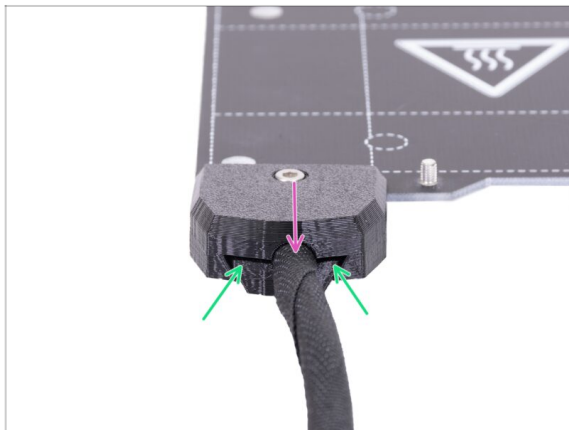

- ◆ Slightly pull on the sleeve to make sure it is properly inserted.
- ◆ Make sure there is no big gap between both covers.

STEP 26 Mounting the heatbed assembly

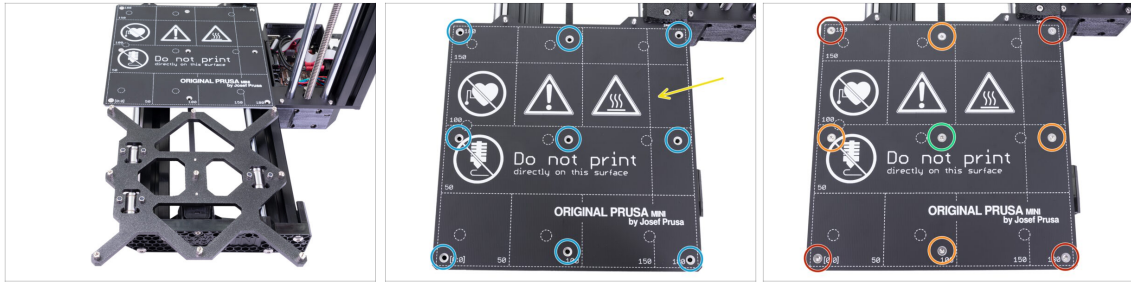

- Push the Y-carriage to the front and place the Heatbed behind.
- Place the heatbed on the Y-carriage.
- Align all 9 holes on the heatbed with the heatbed spacers.
- Insert the M3x4b screws in the holes. **DON'T fully tighten the screws.**
- After all screws are in place, use the torx key to tighten them in the following order:
 - Center screw
 - First four screws (edges)
 - Last four screws (corners)

STEP 27 Heatbed: reward yourself!



- You just finished the **Heatbed assembly**. It was easy.
- Eat the second part of the third row.

STEP 28 Printhead and Heatbed are finished!



- ◆ **You're getting closer!**
- ◆ Check the final look, compare it to the picture.
- ⚠ **Don't place the steel sheet on the heatbed yet.** Wait for the instructions in the Wizard during the calibration process.
- ⚠ **Leave the remaining M3x12 and M3x20 screws** in the Print head, HB, ELE package for the next chapter.
- ⓘ Keep the remaining Spool Holder packages for later.
- ◆ Ready for the next chapter? Let's jump into: **5. LCD assembly & Electronics**

5. LCD assembly & Electronics



STEP 1 Tools necessary for this chapter

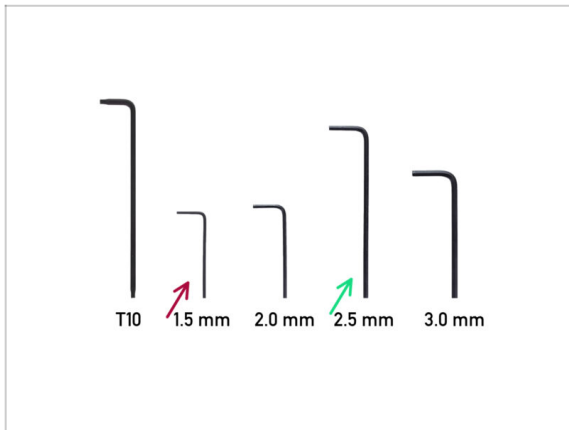

- For this chapter please prepare:
- 1.5mm Allen key
- 2.5mm Allen key

STEP 2 LCD assembly: parts preparation



① All the printed parts and fasteners needed for this chapter are included in the box:
HARIBO & LCD

- For the following steps, please prepare:
- LCD assembly (1x)
- M3x20 screw (1x) *leftover from the previous chapter*

STEP 3 Mounting the LCD



- ◆ First, carefully tilt the printer on its side. See the picture.
 - ◆ Place the LCD into the LCD holder. There is a notch, which fits inside the printed part on the printer.
 - ◆ The design allows you to tilt the LCD into multiple positions. You can do it now or later.
 - ◆ Use the M3x20 screw to connect both parts together.
- i** Pro tip: if you find it difficult to tighten the screw, turn over the Allen key and insert the short side of the key into the screw head. Tighten by the longer side of the key.

STEP 4 Connecting the LCD



- ◆ Carefully remove the free end of the LCD cable from the box with the electronics and guide the cable between the Y-axis motor cable and the extrusion.
- ◆ Connect the cable to the board on the LCD. Mind the correct orientation of the connector. Use the notch as a guide.
- ◆ Insert the connector in the socket on the board. Make sure it is all the way in.

STEP 5 LCD cable guidance

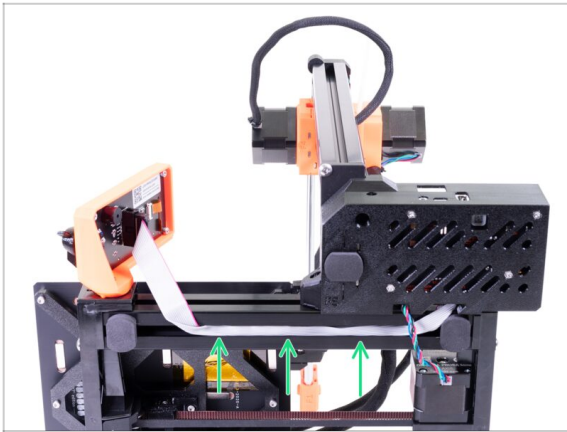

- ◆ Gently insert the cable inside the extrusion. Leave some slack outside near the LCD, so you can tilt it later on.
- ⓘ Pro tip: to insert the cable in the extrusion carefully bend it into two halves along its length.

STEP 6 LCD assembly: reward yourself!



- ◆ You just finished the **LCD assembly**. That wasn't a difficult part of the chapter, but mounting the LCD to the printer required more force and energy. So, reward yourself and replenish your energy :).
- ◆ Eat the first part of the fourth row.

STEP 7 Optional: ESP Wi-Fi Module



⚠ This step is optional, valid only if you bought the ESP-01 Wi-Fi module together with the MINI+ printer.

- ◆ Now, it might be a good time to install the **optional ESP Wi-Fi module**, before we attach the rest of the electronics.
- ◆ The module installation is described in [steps 7-9 of the separate MINI Wi-Fi guide](#).
- ◆ After installing the module, return to this guide and finish the MINI+ assembly. Then, you can [setup the Wi-Fi and PrusaLink](#)

STEP 8 Power switch: parts preparation



- ◆ **For the following steps, please prepare:**
- ◆ Power switch assembly (1x)

STEP 9 Mounting the power switch



- ◆ Guide the power cables through the square hole in the MINI-Z-bottom like in the picture.
- ◆ Make sure the OFF "o" symbol is on the right.
- ◆ Push the power switch evenly with your thumbs to the MINI-Z-bottom.

STEP 10 Connecting the power switch

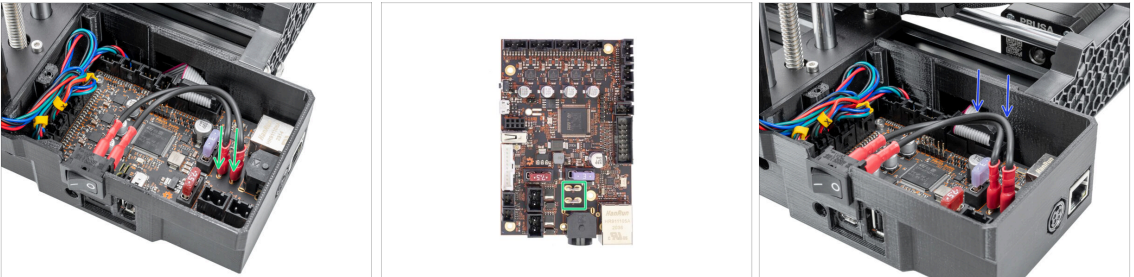

- ◆ Connect both power cables to the pins on the Buddy board. The order of cable connections, polarity and orientation doesn't matter.
- ⚠ **Make sure the connectors are fully connected.** The gap between the connectors and the Buddy board should be approximately 1-2 mm.
- ⚠ **Make sure the connectors are not loose and do not wobble.** This can cause fatal destruction of the electronics.
- ◆ Carefully push the cables down so that they don't protrude from the MINI-Z-bottom.

STEP 11 Filament sensor: parts preparation (optional)

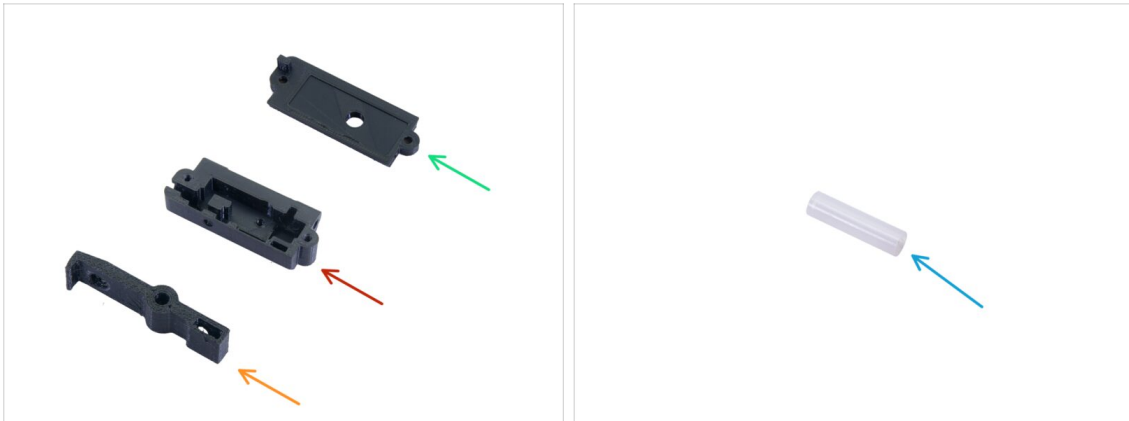

i Some of the following steps are marked as optional. If you have a printer without the filament sensor, please skip to the step [Connecting the electronics](#).

◆ For the following steps, please prepare:

◆ MINI-fsensor-lever (1x)

◆ MINI-fsensor-box (1x)

◆ MINI-fsensor-cover (1x)

◆ PTFE tube 4x2x15 (1x)

i The list continues in the next step...

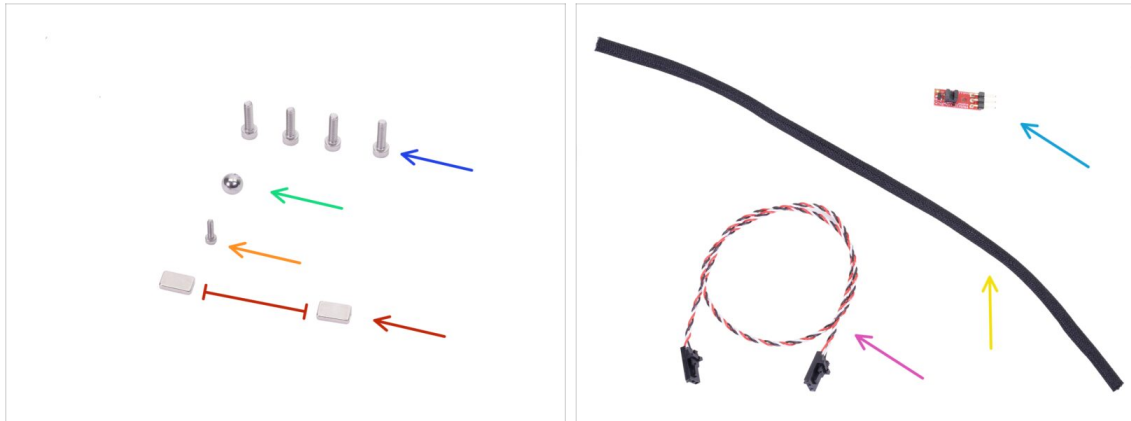
STEP 12 Filament sensor: parts preparation (optional)

● For the following steps, please prepare:

- M3x12 screw (4x)
- Steel ball (1x)
- M2x8 screw (1x)
- Magnet 10x6x2 mm (2x) **Keep the magnets apart in a sufficient distance. They can break each other!**
- IR sensor cable (1x)
- IR sensor (1x)
- Textile sleeve 5x300 mm (1x)

STEP 13 Filament sensor assembling (optional)

- Connect the IR sensor cable to the IR sensor.
- See the clip on the connector and the notch on the sensor for better orientation.
- Guide the cable under the IR sensor like in the picture.
- Insert the IR sensor to the MINI-fsensor-box.
- Make sure the cable is still under the sensor.

STEP 14 Filament sensor assembling (optional)

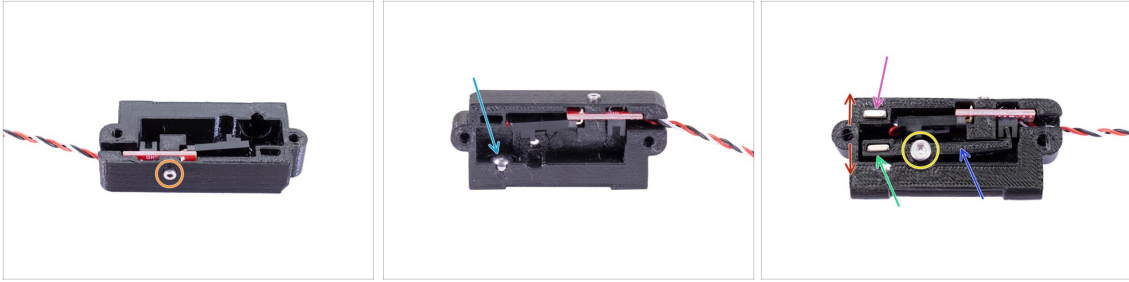

- 🟠 Secure the IR sensor with the M2x8 screw.
- 🟡 Insert the steel ball to the hole in the box.
- 🟢 Place the MINI-fsensor-lever to the box.
- 🟠 Secure it with the M3x12 screw. **Do not tighten too much.** The lever must move freely.
- 🟡 Insert the magnet in the MINI-fsensor-lever.
- 🟢 Insert the magnet in the MINI-fsensor-box.
- 🟠 The magnets must repel each other.

⚠️ **Make sure the MINI-fsensor-lever can move freely and the magnets repel each other.**

STEP 15 Filament sensor assembling (optional)

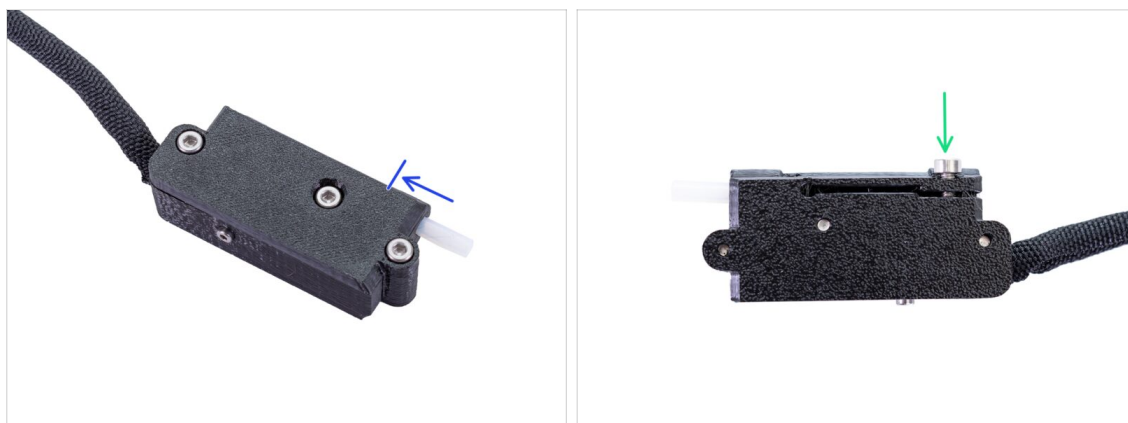

- 🟡 Wrap the textile sleeve around the filament sensor cable and slide it into the box as far as possible.
- 🟢 Place the MINI-fsensor-cover to the filament sensor assembly.
- 🟠 Secure it with two M3x12 screws.

STEP 16 Filament sensor assembling (optional)

- ◆ Insert the PTFE tube all the way to the filament sensor assembly. The orientation of the tube does not matter, both ends are chamfered.
 - ⚠ **Make sure to insert the tube from the correct side. The textile sleeve must be on the opposite side. See the picture.**
- ◆ Insert and slightly tighten the M3x12 screw. **Do not tighten the screw.** We will do it later.

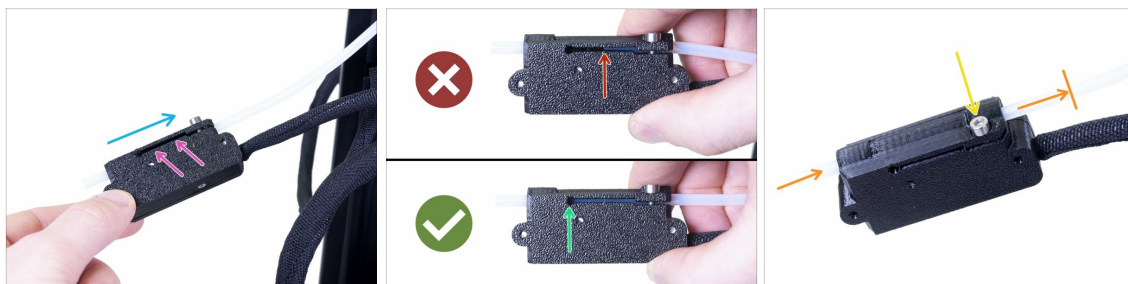
STEP 17 Filament sensor installation (optional)

- ◆ Slide the filament sensor onto the PTFE tube. See the picture for the correct orientation of the sensor.
- ◆ Check the position of the PTFE tube through the groove:
 - ◆ **Wrong installation.** The filament sensor is not fully pushed onto the PTFE tube. The filament sensor will not work properly.
 - ◆ **Correct installation.** The filament sensor is fully pushed onto the PTFE tube.
- ◆ Now, tighten the screw gently to ensure the sensor won't slide from the PTFE tube.
- ◆ Use a piece of filament and slide it through the filament sensor to ensure the proper functioning of the tube. In case of any resistance, release the screw slightly.

STEP 18 Connecting the filament sensor (optional)

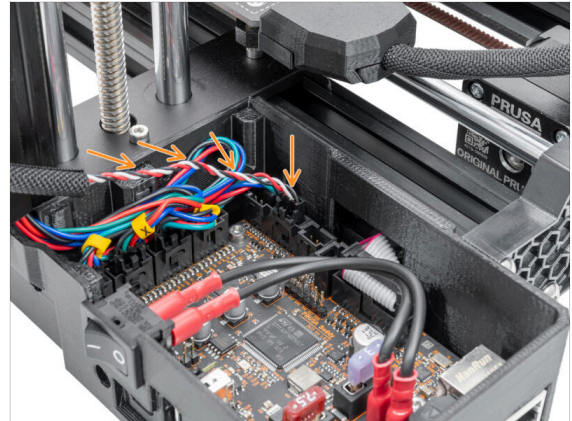
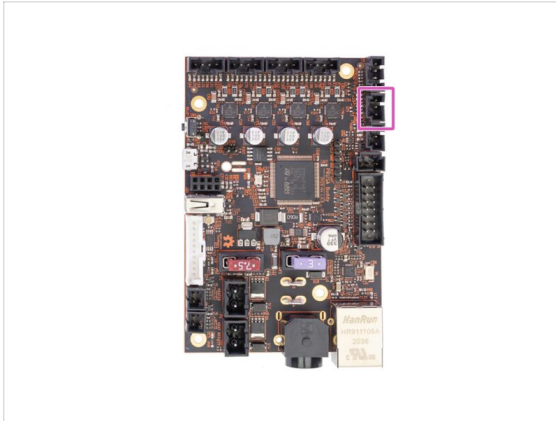

- ◆ Connect the filament sensor cable to the Buddy board.
- ◆ Arrange the cable according to the picture. Keep in mind that the electronics cover must fit into place.

STEP 19 Connecting the electronics

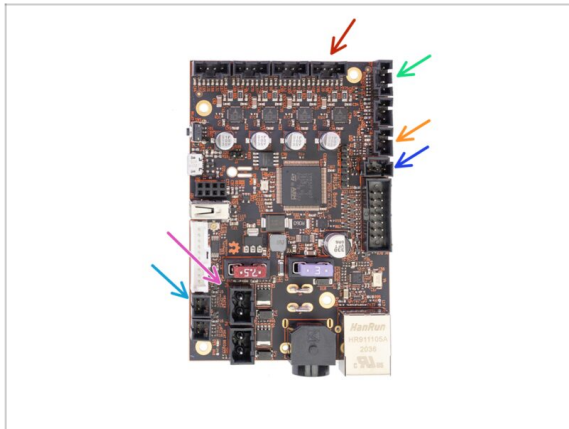

- ◆ Let's connect the cables to the electronics. Start from the top and proceed "clockwise" according to the instructions:
 - ◆ E-axis motor cable (labeled E)
 - ◆ SuperPINDA sensor cable
 - ◆ Print fan cable
 - ◆ Hotend fan cable
 - ◆ Hotend thermistor
 - ◆ Hotend cables
- ⓘ Continue in the next step...

STEP 20 Connecting the electronics

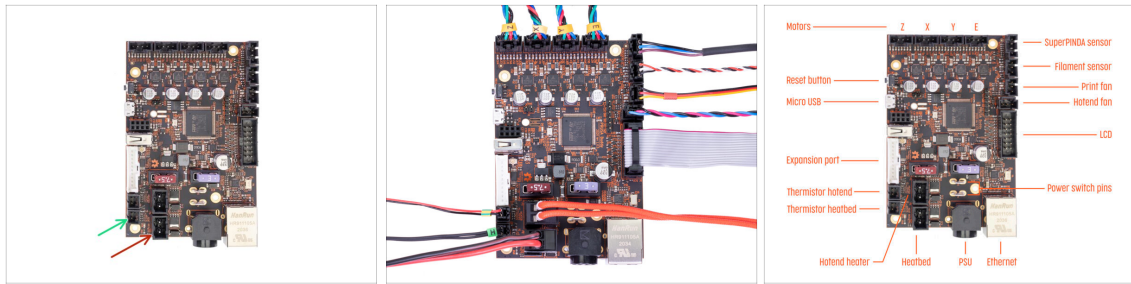

- ◆ Heatbed thermistor (labeled H)
- ◆ Heatbed cable
- Check the wiring connection according to the picture.

STEP 21 Covering the electronics: parts preparation



- **For the following steps, please prepare:**
- ◆ MINI-Z-bottom-cover (1x)
- ◆ MINI-Z-bottom-cable-cover (1x)
- ◆ M3x12 screw (1x)

STEP 22 Covering the electronics

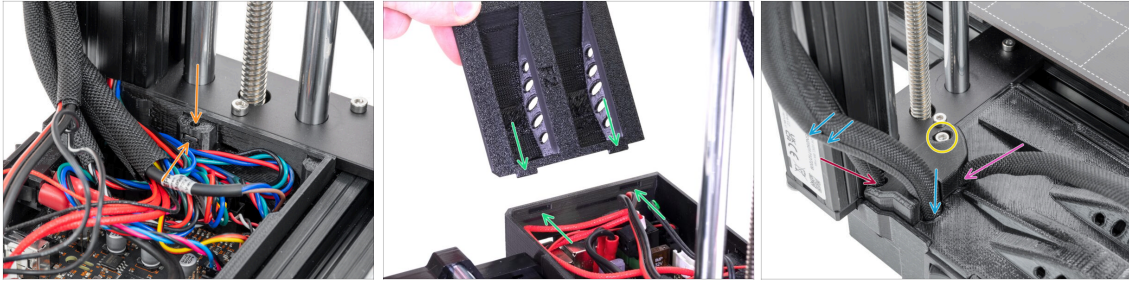

- 🟠 Before covering the electronics, make sure the square nut is correctly positioned in the printed part. **The nut must not fall out!** This can cause fatal damage to the electronics.
- 🟢 Insert the "teeth" of the cover into the grooves of the MINI-Z-bottom.
- ⬛ **Place the second cover on the top and arrange the cables:**
 - 🟡 **Extruder bundle**, ensure the textile sleeve is partially in. Also, it must be tilted away from the printer.
 - 🟣 **Heatbed bundle**, ensure the textile sleeve is partially inside the box.
 - 🟠 **Filament sensor cable** (optional), ensure that the textile sleeve wrapped around the cables is partially inside the box.
- 🟡 Now, tighten the second cover. Check that no cable is pinched.

STEP 23 Gluing the silver label



- i** New kit units are shipped with a silver label already affixed to the aluminium extrusion. If you already have a label affixed by us, skip this step.
- ⚠ WARNING:** This step is important, don't skip it! The silver label includes the printer's serial number and other important information. Its presence is necessary for any warranty claim. **In case the label is already on the frame, please skip this step.**
- Rotate the printer, so that the side with the power button and USB faces towards you.
- Carefully peel off the protective layer and glue the label on the side of the extrusion. Ensure there is no air trapped below the label. The orientation of the sticker doesn't matter.

STEP 24 Electronics: reward yourself!



- You just finished the **Electronics**. It wasn't difficult, but it required a certain amount of concentration. Please, reward yourself!
- Eat the second part of the fourth row.

STEP 25 LCD assembly & Electronics are finished!



- ◆ Congratulations, you've just assembled the **Original Prusa MINI+**!
- ◆ Check the final look, compare it to the picture.
- ◆ Checked everything? Proceed to the next step, which will guide you through the instructions to assemble the spool holder.

STEP 26 New vs old Spool holder assembly

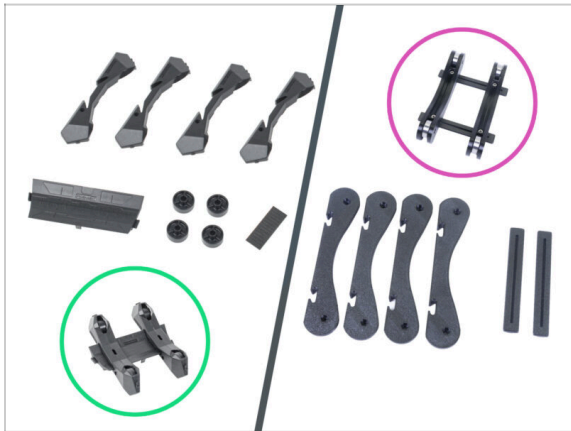

- ⚠ **There are two variants of the spool holder, which differ in design and in the process of assembling.**
- ◆ **Take a closer look at the items from the SPOOL HOLDER package and choose the appropriate instructions:**
 - ◆ **NEW version** - spool holder parts are injection molded including wheels. Go to **6A. Spool holder assembly**
 - ◆ **OLD version** - spool holder parts are printed except wheels (bearings). Go to **6B. Spool holder assembly**

6A. Spool holder assembly



STEP 1 Injection molded holder: parts preparation

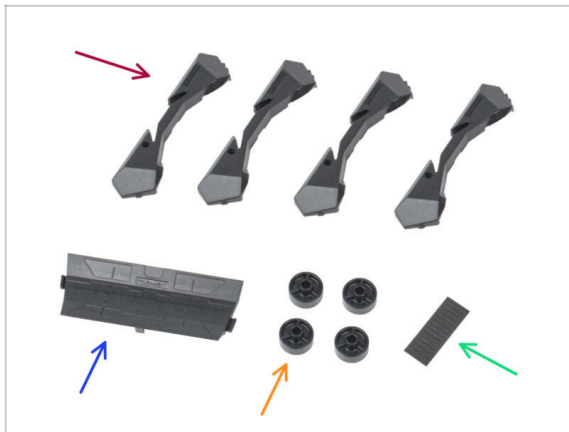

◆ For the following steps, please prepare:

- ◆ Spool holder Base (4x)
- ◆ Spool holder Guide (1x)
- ◆ Spool holder Wheel (4x)
- ◆ Sheet of Foam Pads (1x)

STEP 2 Base assembly (part 1)



- ◆ Take one Base part. Arrange it as seen in the picture.
- ◆ Insert two wheels into the Base.
- ◆ Cover the assembly with another Base part on top.

STEP 3 Base assembly (part 2)

- ◆ Push both Base parts together until they fully engage one into the other.
- ◆ Verify the Base parts hold together properly.
- ◆ Repeat the same steps for the other side part of the spool holder, until you get two of these.

STEP 4 Foam pads installation (part 1)

- ◆ Take the foam pad sheet. Bend it to separate the individual foam pad strips.
- ◆ There is a bending line inside the inner opening on the bottom of the spoolholder side part.
- ◆ Attach an individual foam pad strip onto the middle of the bending line inside the opening, as seen in the picture.

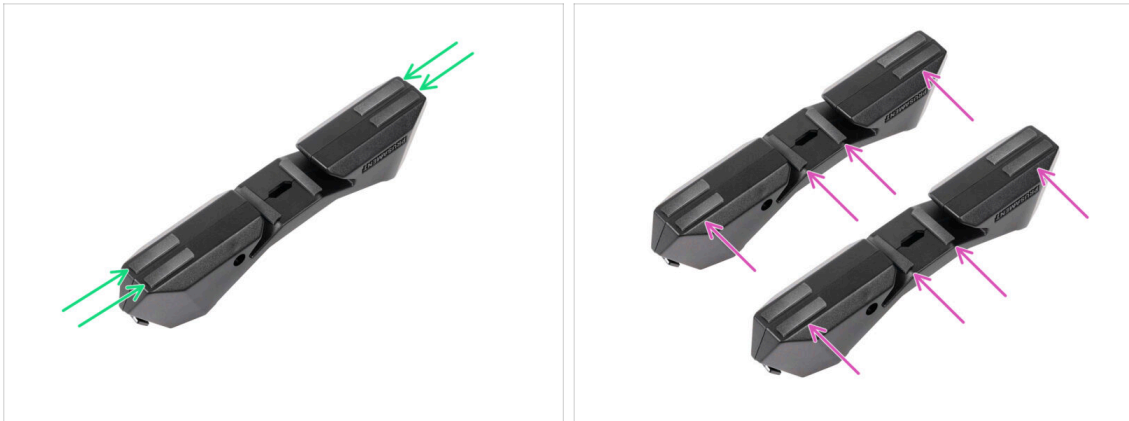
STEP 5 Foam pads installation (part 2)

- Attach another four foam pad strips onto the marked positions on the bottom of the spool holder side part.
- Install another six foam pad strips onto the other side part of the spool holder.

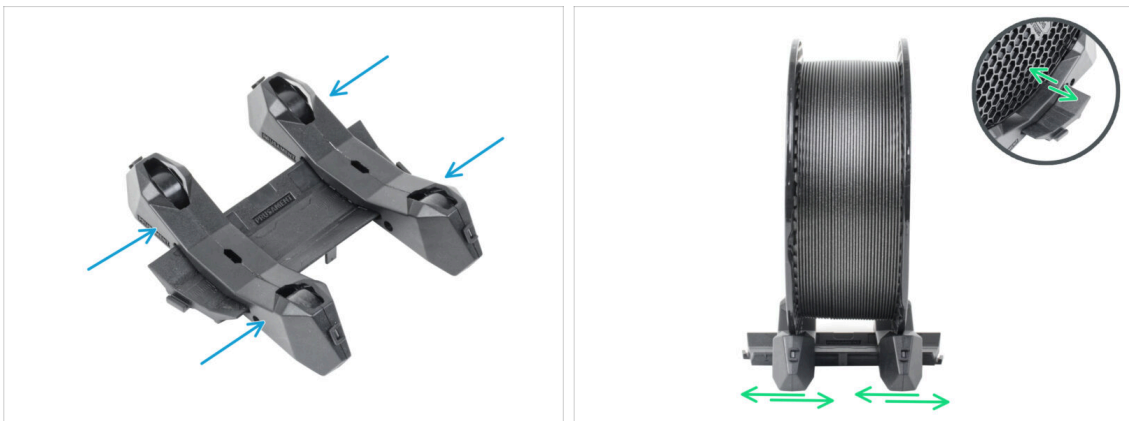
STEP 6 Adjusting the spool holder width

- Slide the side parts onto the Guide part.
- Place a spool of the filament you wish to use in the spool holder. Align the side parts to match the spool. *We are using a spool of Prusament as an example.*

STEP 7 Spool holder assembly: reward yourself!



- ◆ You just finished the **Spool holder assembly**. That was fast!
- ◆ Eat the fifth row.

STEP 8 Spool holder is assembled!



- ◆ Check the final look, and compare it to the picture.
- ◆ That was easy, wasn't it? ;) Now it's finally time for the last chapter: **7. Preflight check**

6B. Spool holder assembly



STEP 1 Tools necessary for this chapter

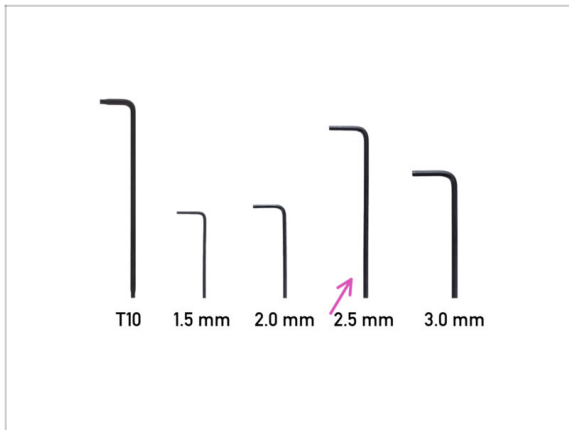

- For this chapter please prepare:
- ◆ 2.5mm Allen key

STEP 2 Spool holder: parts preparation

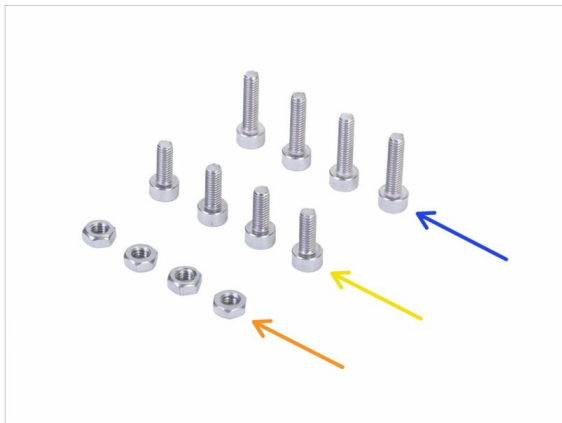
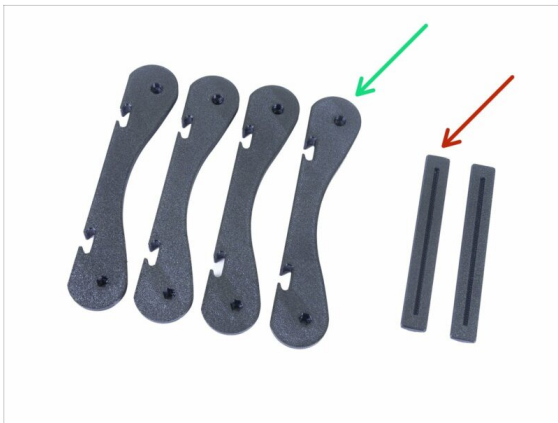

ⓘ All the printed parts and fasteners needed for this chapter are included in the box:
Print head & Heatbed

● For the next steps, please prepare:

◆ MINI-base-spool-holder (4x)

◆ MINI-rail-spool-holder (2x)

◆ M3x12 screw (4x)

◆ M3x8 screw (4x)

◆ M3n nut (4x)

ⓘ The list continues in the next step...

STEP 3 Spool holder: parts preparation

● For the following steps, please prepare:

- Bearing 608Z (4x)
- Anti-vibration pad (4x)

STEP 4 Assembling the spool holder base(s)

- Take two of the BASE parts and insert the M3n nuts into the holes in both of them - see the picture (they are identical). If you can't push them in, insert a screw from the opposite side to pull them in.
- Flip one of the BASE parts and insert two bearings in it.
- Put the second BASE part on top of the bearings.
- Insert the M3x12 screw from the top and tighten it. Flip the base assembly over and do the same.
- Make sure both bearings can rotate freely. If not, release the screw(s) slightly.
- Repeat this step for the second base assembly.

STEP 5 Adding the spool holder rails



- ◆ Slide both rails in the first base assembly, use the grooves. Align the rail with the edge of the base.
- ◆ Secure the first base with two M3x8 screws. Use a reasonable force during the tightening.
- ◆ Slide the second base onto the rails. The exact position is not important at this point - we will adjust it in the next step.

STEP 6 Adjusting the spool holder width



- ◆ Place a spool of the filament you wish to use in the spool holder. Align the second base to match the size of the spool. *We are using a spool of Prusament as an example.*
- ◆ Once the holder is aligned, remove the spool, insert two M3x8 screws and tighten them to prevent the parts from moving.

STEP 7 Attaching anti-slip pads

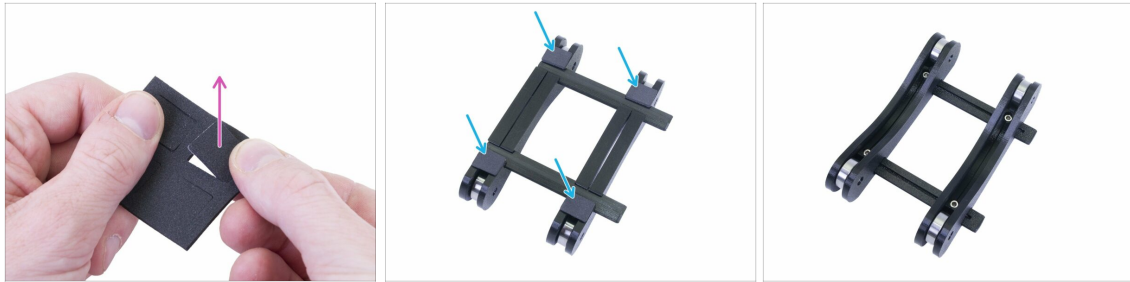

- ◆ Grab the bundled anti-slip board and break out four pads.
- ◆ Peel off the protective film and attach the pads from the bottom side of the spool holder.
- ⓘ Tip: avoid attaching the pads near or on the rails, it might make future width adjustments harder.

STEP 8 Spool holder assembly: reward yourself!

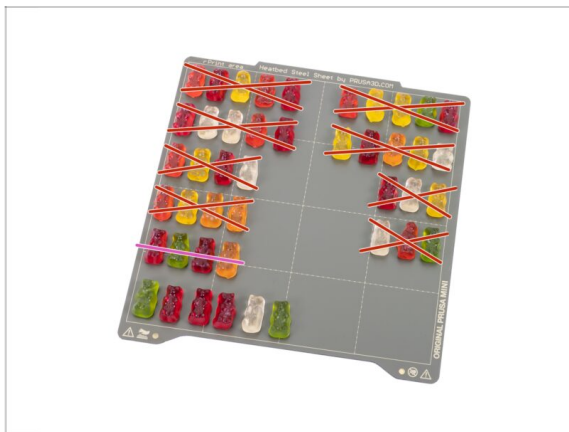

- ◆ You just finished the **Spool holder assembly**. That was fast!
- ◆ Eat the fifth row.

STEP 9 Spool holder is assembled!



- ◆ Check the final look, compare it to the picture.
- ◆ That was easy, wasn't it? ;) Now it's finally time for the last chapter: **7. Preflight check**

7. Preflight check



STEP 1 SuperPINDA sensor height adjustment



- Using your fingers turn the lead screw and move the entire X-axis down. **Stop when the hotend touches the heatbed! Avoid bending the heatbed!**
- Release slightly the screw on the MINI-minda-holder so you are able to adjust the position of the SuperPINDA sensor.
- Take a zip tie from the package and place it under the SuperPINDA sensor. Use the middle part of the zip tie, not the tip.
- Gently press the SuperPINDA sensor down against the zip tie.
- Tighten the screw on the MINI-minda-holder. **Do not use excessive force.** Otherwise, you can break the printed part!
- Rotate the lead screw manually in the opposite direction to move the axis at least 5 mm up.

STEP 2 Finalising the assembly

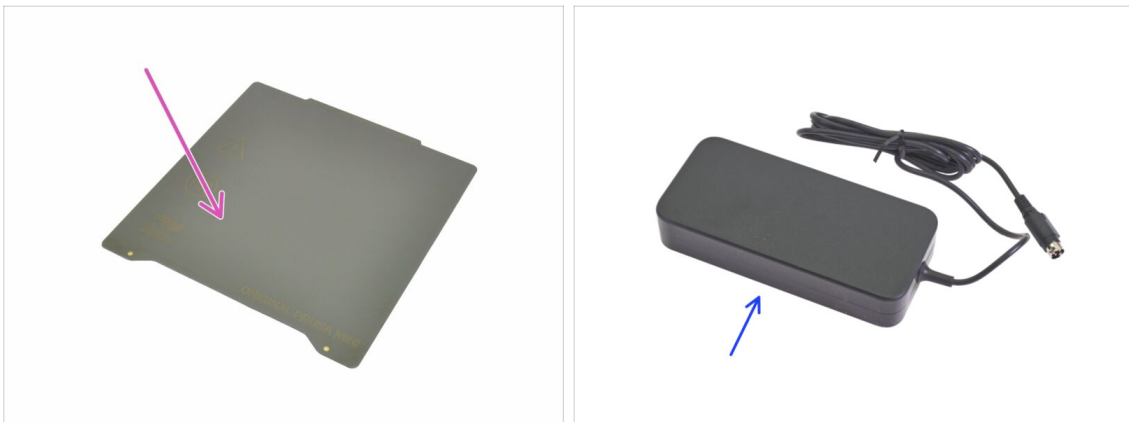

- **For the following step, please prepare:**
- PEI MINI+ sheet (1x)
- MINI+ power supply (1x)
- **i** Older units may have a slightly different look of the PSU. However, the functionality is the same.

STEP 3 Connecting the power supply



- ◆ Connect the MINI+ power supply to the printer. Keep in mind the connector isn't symmetrical.
- ◆ Remove the protective film from the display.
- ◆ Place the PEI MINI sheet on the heatbed. Double-check it is oriented correctly.

STEP 4 Finalizing



- ◆ Now, please read the **3D Printing Handbook**, which is tailor-made for your printer and **follow the instructions to set up the printer properly**. The latest version is always available at prusa3d.com/3dhandbookMINI
- ◆ Use the bundled test prints on USB flash drive to ensure your printer works correctly.

STEP 5 Printable 3D models

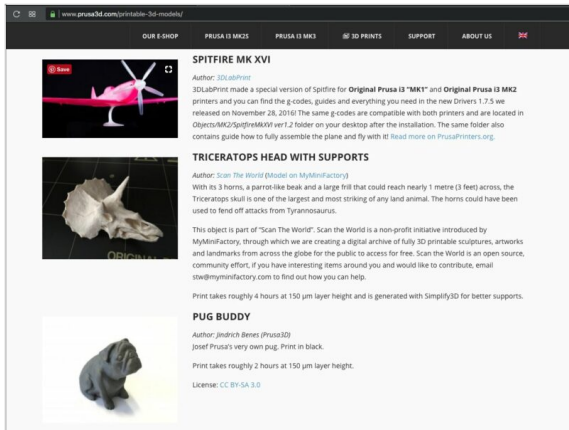

- Read the chapter *Printing* in 3D Printing Handbook.
- **Congratulations! You should be ready to print by now ;-)**
- You can start by printing some of our test objects bundled on the included USB stick - you can check them out here prusa3d.com/printable-3d-models

STEP 6 Prusa knowledge base

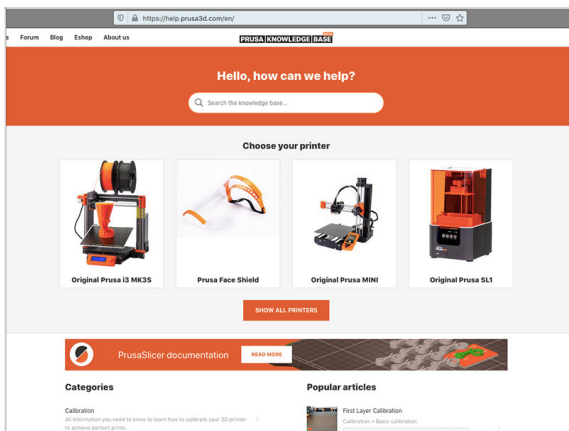

- If you encounter any problems at all, don't forget you can always check out our knowledge base at help.prusa3d.com
- We're adding new topics every day!

STEP 7 It works! Reward yourself.

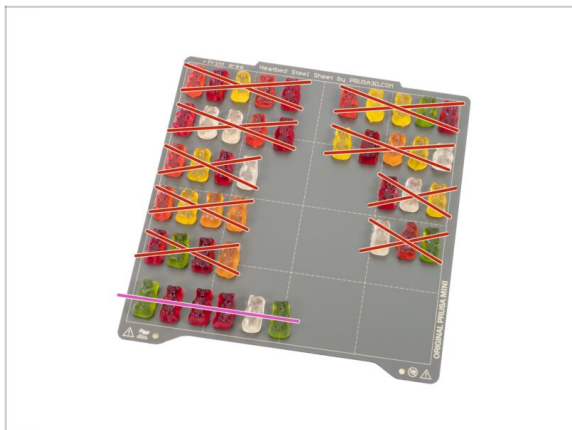

- ◆ **You did a great job!** Now you can relax, take your last dose of sweets and plunge into the endless fun of 3D printing :)
- ◆ Eat the remaining gummy bears.

STEP 8 Join Printables!

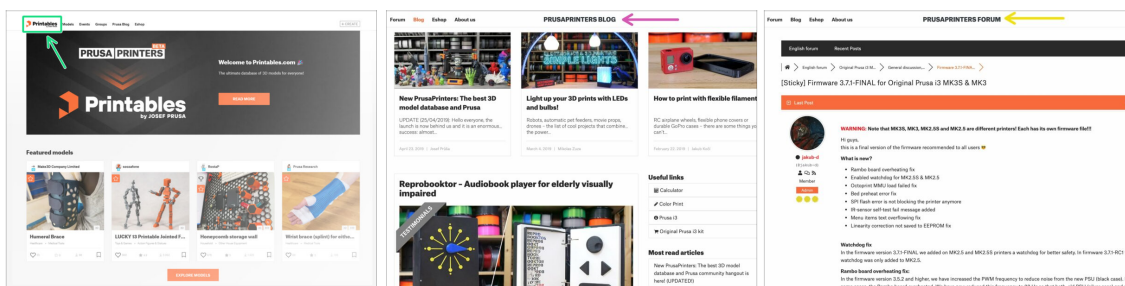

- ◆ **Don't forget to join the biggest Prusa community! Download the latest models in STL or G-code tailored for your printer. Register at [Printables.com](https://www.printables.com)**
- ◆ Looking for an inspiration on new projects? Check our blog with weekly updates.
- ◆ If you need help with the build, check out our forum with great community :-)
- i All services share one account.

Manual changelog MINI+ kit



STEP 1 Version history



- Versions of the MINI+ kit assembly manual:
 - 01/2021 - Initial version 1.05
 - 02/2021 - Updated to version 1.06
 - 03/2021 - Updated to version 1.07
 - 11/2021 - Updated to version 1.08
 - 05/2023 - Updated to version 1.09

STEP 2 Changes to the manual (1)



- 02/2021 - YZ-axis assembly
 - Improved inspection holes to check the insertion of the smooth rods in the MINI-Z-bottom.
- 02/2021 - X-axis & Extruder assembly
 - Added inspection holes to check the insertion of the smooth rods in the MINI-X-end.
- 02/2021 - X-axis & Extruder assembly
 - The dimension of the gap between the motor and the X-axis pulley has been changed from 2 mm to 0.7 - 1 mm.
- i** Manual version 1.06

STEP 5 Changes to the manual (4)



- 05/2023 - Spool holder assembly
 - Added instructions for assembling the new version of the Spool holder (injection molded).
- ⓘ Manual version 1.09

STEP 6 Changes to the manual (5)

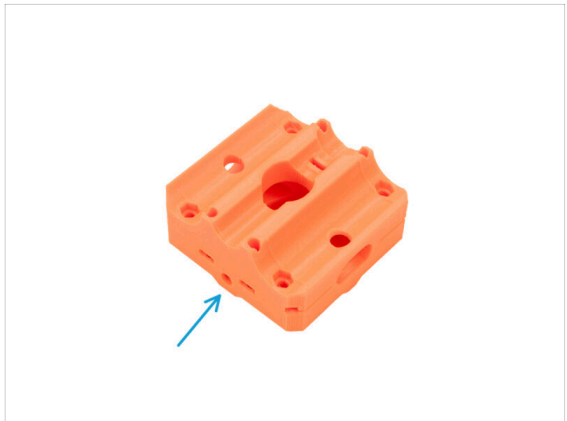
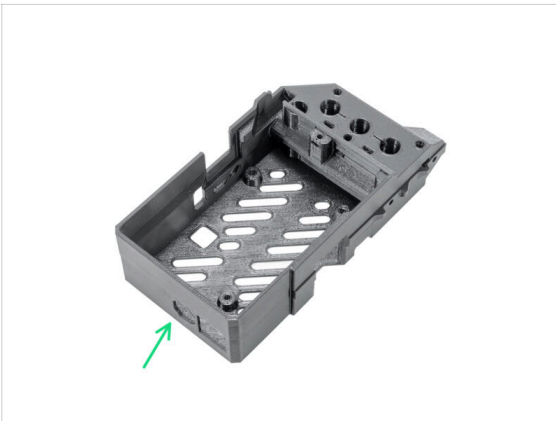

- 02/2025 - MINI-Z-bottom & Z-carriage assembly
 - Added instructions for assembling the new version of the MINI-Z-bottom.
 - Added instructions for assembling the new version of the Z-carriage.
- Manual version 1.1

