

Table of Contents

1. Introduction	5
Step 1 - Preparing the upgrade kit	6
Step 2 - Getting the necessary tools	7
Step 3 - Labels guide	7
Step 4 - Spare bag	8
Step 5 - Printed parts - self printing	8
Step 6 - Printable parts - Silver to Black PSU	9
Step 7 - Printed parts post-processing	10
Step 8 - We are here for you!	11
Step 9 - Pro tip: inserting the nuts	12
Step 10 - View high resolution images	12
Step 11 - Important: Electronics protection	13
Step 12 - Reward yourself	14
Step 13 - How to successfully finish the assembly	15
Step 14 - Prepare your desk	16
2. Parts check	17
Step 1 - Introduction	18
Step 2 - Preparing the printer	19
Step 3 - Heatbed inspection	20
Step 4 - Heatbed surface inspection	20
Step 5 - X-axis smooth rods inspection	21
Step 6 - Y-axis smooth rods inspection	22
Step 7 - Printer frame inspection	22
Step 8 - For new users of black PSU	23
Step 9 - Can I open the Haribo?	23
Step 10 - Let's get started	24
3. Printer disassembly	25
Step 1 - Disconnecting cables	26
Step 2 - Removing the electronics box	26
Step 3 - Removing the einsy-door	27
Step 4 - Removing the heatbed	27
Step 5 - Removing the heatbed cable cover	28
Step 6 - Releasing the cable management	28
Step 7 - Disconnecting the LCD cables	29
Step 8 - Disconnecting the PSU cables (Black PSU)	29
Step 9 - Removing the LCD assembly	30
Step 10 - Still no sweets?	30
Step 11 - Parts summary	31
4. xBuddy assembly	32
Step 1 - Tools necessary for this chapter	33
Step 2 - xBuddy box: parts preparation I.	33
Step 3 - xBuddy box: parts preparation II.	34
Step 4 - Inserting the M3nEs nuts	34
Step 5 - Mounting the xBuddy box	35
Step 6 - Mounting the xBuddy box	36
Step 7 - Mounting the xBuddy box	36
Step 8 - Applying the thermal pads	37
Step 9 - Mounting the xBuddy board	37
Step 10 - Attaching the zip ties	38
Step 11 - Haribo	39

Step 12 - It's done	39
5. xLCD & PSU assembly	40
Step 1 - Tools necessary for this chapter	41
Step 2 - Cable clips: parts preparation	41
Step 3 - Installing the cable clips	42
Step 4 - Installing the cable clips	42
Step 5 - xLCD assembly: parts preparation	43
Step 6 - xLCD assembly: parts preparation (part 2)	43
Step 7 - xLCD assembly: inserting the square nuts	44
Step 8 - Installing the xReflector sticker	44
Step 9 - Assembling the xLCD-support-right	45
Step 10 - Installing the PE Faston	45
Step 11 - Assembling the xLCD-support-left	46
Step 12 - xLCD cables: parts preparation	46
Step 13 - Connecting the PE cable: xLCD	47
Step 14 - Attaching the knob	47
Step 15 - Attaching the xLCD assembly	48
Step 16 - Guiding the xLCD cable	48
Step 17 - Connecting the PE cable: xBuddy	49
Step 18 - Black vs Silver PSU	49
Step 19 - PSU cables (black PSU): parts preparation	50
Step 20 - Connecting the PSU (Black PSU): PE cable	50
Step 21 - Power cables info (Black PSU)	51
Step 22 - Connecting the PSU (Black PSU)	52
Step 23 - Connecting the power panic (Black PSU)	53
Step 24 - Guiding the power cable bundle (Black PSU)	53
Step 25 - Guiding the power cable bundle (Black PSU)	54
Step 26 - Connecting the PSU cable (Black PSU): parts preparation	54
Step 27 - Guiding the PSU cables (Black PSU): PE cable	55
Step 28 - Connecting the PSU cables (Black PSU): PE cable	55
Step 29 - PSU - PE cable (Silver PSU): parts preparation	56
Step 30 - Inserting M3nEs nut (Silver PSU)	56
Step 31 - Guiding the PE cable (Silver PSU)	57
Step 32 - Connecting the PE cables (Silver PSU)	57
Step 33 - Connecting the extended PE cable (Silver PSU)	58
Step 34 - Guiding the Z motor right cable (Silver PSU)	58
Step 35 - Guiding the power cable bundle (Silver PSU)	59
Step 36 - Guiding the power cables (Silver PSU)	59
Step 37 - Power panic extended cable (Silver PSU): parts preparation	60
Step 38 - Extending the power panic cable (Silver PSU)	60
Step 39 - Connecting the PE cable (Silver PSU)	61
Step 40 - Connecting the PSU cables (Silver PSU)	61
Step 41 - Connecting the power panic cable (Silver PSU)	62
Step 42 - Securing the PSU cables	62
Step 43 - Guiding the Z motor left cable	63
Step 44 - Motor cable adapters: parts preparation	63
Step 45 - Connecting the motor cable adapters	64
Step 46 - Connecting the motor cables	64
Step 47 - Connecting the xLCD cables	65
Step 48 - Haribo	65
Step 49 - That's it	66
6. Heatbed upgrade	67
Step 1 - Tools necessary for this chapter	68
Step 2 - Removing the heatbed thermistor	68

Step 3 - New heatbed thermistor: parts preparation	69
Step 4 - Preparing the heatbed and thermistor	69
Step 5 - Covering the thermistor	70
Step 6 - Fixing the thermistor in place	70
Step 7 - Heatbed cable assembly: parts preparation	71
Step 8 - Heatbed cable assembly (part 1)	71
Step 9 - Heatbed cable assembly (part 2)	72
Step 10 - Heatbed cable assembly (part 3)	72
Step 11 - Covering the heatbed cables: parts preparation	73
Step 12 - Assembling the heatbed-cable-cover-bottom	73
Step 13 - Assembling the heatbed-cable-cover: nylon filament	74
Step 14 - Assembling the heatbed-cable-cover-bottom	74
Step 15 - Assembling the heatbed-cable-cover-top	75
Step 16 - Wrapping the textile sleeve	75
Step 17 - Installing the Expansion joints: parts preparation	76
Step 18 - Preparing the expansion joints	76
Step 19 - Installing the Expansion joints	77
Step 20 - Attaching the heatbed: parts preparation	77
Step 21 - Attaching the heatbed	78
Step 22 - Tightening the heatbed	78
Step 23 - Heatbed-cable-holder: parts preparation	79
Step 24 - Guiding the heatbed cables	79
Step 25 - Covering the heatbed cables	80
Step 26 - Installing the ESP module: parts preparation	80
Step 27 - Installing the ESP module	81
Step 28 - Reward yourself!	81
Step 29 - Almost there	82
7. Extruder upgrade	83
Step 1 - Tools necessary for this chapter	84
Step 2 - Removing the nylon filament	84
Step 3 - New nylon filament: parts preparation	85
Step 4 - Cutting the nylon filament	85
Step 5 - Inserting the nylon	86
Step 6 - Wrapping the cable bundle	86
Step 7 - Guiding the cable bundle	87
Step 8 - Ext-cable-holder: parts preparation	87
Step 9 - Attaching the Ext-cable-holder	88
Step 10 - Assembling the Ext-cable-holder	88
Step 11 - Attaching the extruder cable bundle	89
Step 12 - Connecting the X motor cable	89
Step 13 - MK3.5 adapter cable: parts preparation	90
Step 14 - MK3.5 adapter cable connecting (part 1)	90
Step 15 - MK3.5 adapter cable connecting (part 2)	91
Step 16 - MK3.5 adapter cable connecting (part 3)	91
Step 17 - MK3.5 adapter cable connecting (part 4)	92
Step 18 - Verify all connections once more!	92
Step 19 - xBuddy cover: parts preparation	93
Step 20 - Covering the xBuddy box	93
Step 21 - Covering the xBuddy box	94
Step 22 - Labels: parts preparation	94
Step 23 - Upgrading the safety label (optional)	95
Step 24 - xLCD sticker (optional)	95
Step 25 - xLCD sticker (optional)	96
Step 26 - SN label (required)	96

Step 27 - Haribo time!	97
Step 28 - Remaining fasteners	97
Step 29 - Good job!	98
8. Preflight check	99
Step 1 - 3D Printing Handbook	100
Step 2 - Attaching the print sheet	100
Step 3 - Firmware update (part 1)	101
Step 4 - Firmware update (part 2)	101
Step 5 - Wizard - Selftest start	102
Step 6 - Wizard - First layer calibration	102
Step 7 - Wizard - First layer calibration	103
Step 8 - Wizard complete	103
Step 9 - Reward yourself!	104
Step 10 - Printable 3D models	104
Step 11 - PrusaSlicer for MK3.5	105
Step 12 - PrusaLink and Prusa Connect	105
Step 13 - Print your first model	106
Step 14 - Prusa knowledge base	106
Step 15 - Join Printables!	106
Manual changelog MK3.5 upgrade	107
Step 1 - Version history	108

1. Introduction



STEP 1 Preparing the upgrade kit



- ◆ Welcome to our step-by-step guide on upgrading your Original Prusa i3 MK3S/MK3S+ to the **Original Prusa MK3.5**.
- ⚠ **Important:** Please ensure you are using the correct manual. This is the assembly manual for the **Original Prusa MK3.5**.
- ⓘ If you are assembling the Original Prusa MK3.5S, please refer to the [Original Prusa i3 MK3S/MK3S+ to MK3.5S upgrade manual](#).
- ⚠ This upgrade manual is intended for MK3S and MK3S+ printers only. The MK3 version is not supported.
- ◆ Prepare the upgrade kit received from Prusa Research.
- ⚠ **WARNING:** Before you start disassembling the printer, ensure that **you have successfully printed all the required parts** for the upgrade.

STEP 2 Getting the necessary tools

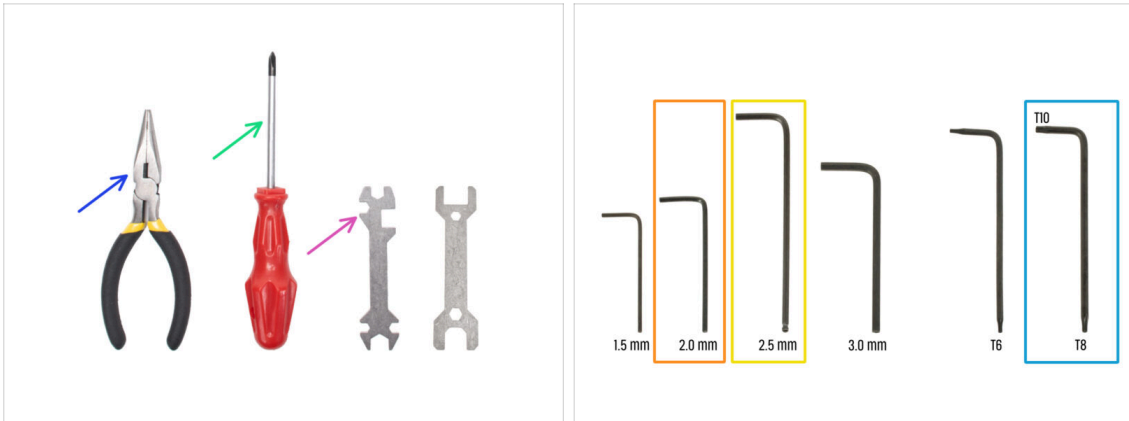

Tools required for the upgrade are:

- ◆ Needle-nose pliers (1x)
- ◆ Philips (PH2) screwdriver (1x)
- ◆ Universal wrench (1x)
- ◆ 2.0mm Allen key
- ◆ 2.5mm Allen key
- ◆ T10 / T8 Torx key

STEP 3 Labels guide

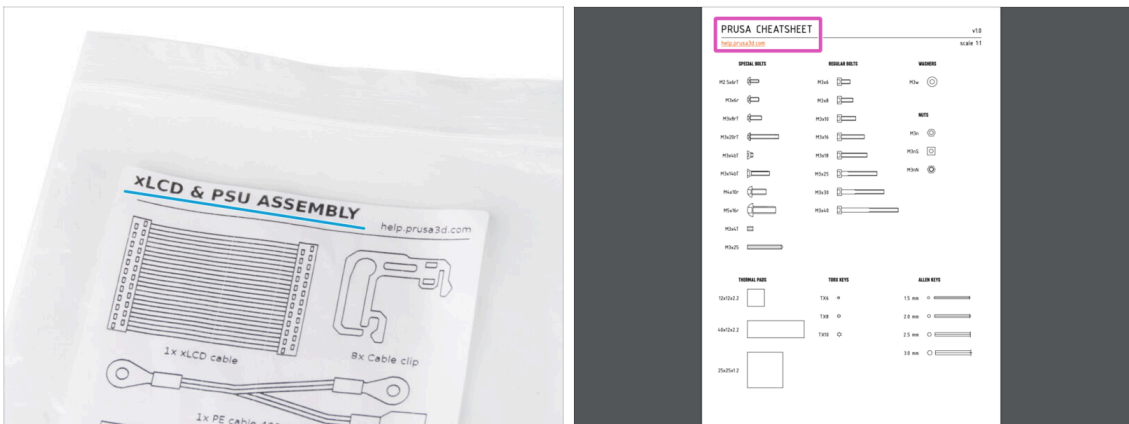

- ◆ All the boxes and bags including parts for the build are labeled.
- ◆ The labels include the list of contents and part count.
- ◆ You can download a **Cheatsheet** with 1:1 fastener drawings from our site prusa.io/cheatsheet-mk4. Print it at 100 %, don't rescale it, otherwise, it won't work.
- i For PRUSA veterans: Fasteners are divided into individual bags according to its type. Not into packages for individual chapters, as it was with previous printers.

STEP 4 Spare bag



- ◆ Spare fasteners are included in each bag of fasteners.
- ⓘ At the end of this manual, you'll find a helpful list detailing any extra fasteners remaining in the package. It will prevent you from worrying that you have more than one of the same type of fasteners left.
- ◆ There is a bag with spare parts like thermal pads, springs, etc.

STEP 5 Printed parts - self printing

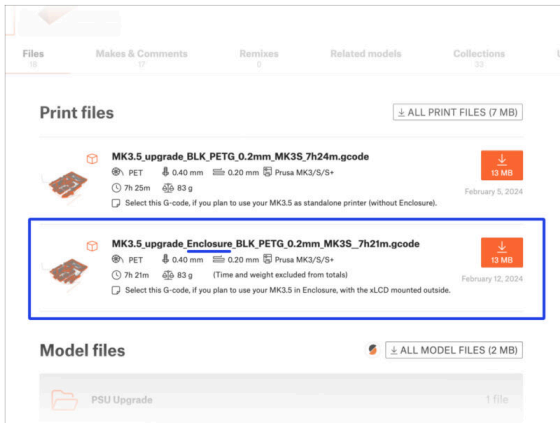
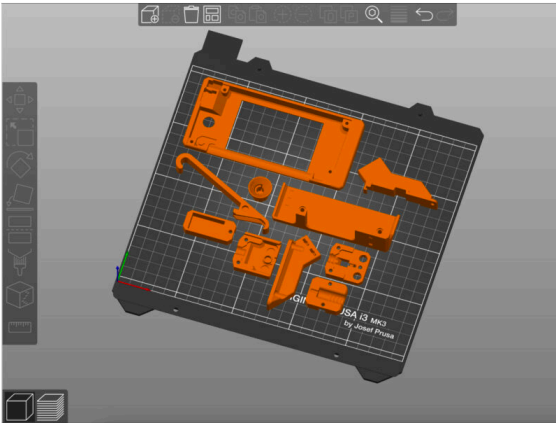

- ⚠ **Before we start disassembly, you need to print all the necessary parts.**
- ◆ Filaments (PETG) for printing all necessary parts are included in the UPGRADE package.
- ◆ G-codes and STL files are available on our website: prusa.io/printable-parts-mk35
- ⓘ For printing individual parts it is recommended to use PrusaSlicer with 0.2 mm layer height, GRID infill at 15 %, no supports!
- ◆ Before installing the MK3.5 upgrade in your Original Prusa Enclosure, be sure to download and print the compatible xLCD supports for Enclosure.
- ⓘ Find the G-code files on prusa.io/printable-parts-mk35.

STEP 6 Printable parts - Silver to Black PSU



- 🟡 This step is for users who have purchased the **black 24V 240W PSU** (Power Supply Unit) and would like to replace an existing silver power supply unit during the upgrade.
- ⬛ **For this replacement, the following parts need to be printed in addition:**
 - 🟡 PSU-cover (1x)
 - 📄 Download the part from PSU Upgrade category on prusa.io/printable-parts-mk35
- ⚠️ **Print the parts according to the prescribed print settings in the description on Printables.com.**

STEP 7 Printed parts post-processing

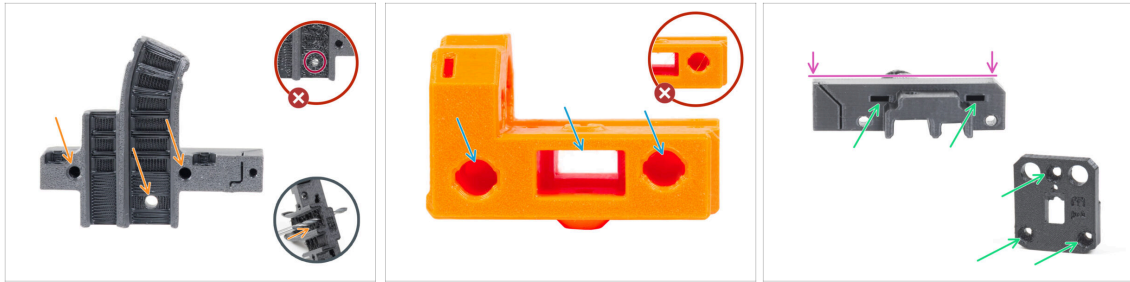

- ◆ **Some parts might require post-processing** in order to be ready for assembly.
- ◆ **In general for all printed parts** (We will use just a few parts as an example):
 - Each hole for a screw, nylon filament, etc. must be clean and free of any strings. If there are any remnants of filament inside the hole, hand drill the holes with a 3mm drill bit. **Do not use electric power tools!**
 - All other holes, for example for the smooth rods, must be perfectly clean. If there is any filament residue inside the hole, use a heat gun to melt it.
 - ⓘ Optimal temperature for the heat gun is 250 °C (482 °F) and blow on the parts from a distance of 10 - 15cm (4 - 6 inches).
 - Check the square and hexagon nut holes. **There must be no filament debris inside.**
 - Check the parts for straightness. For example, by placing it on a clean table surface. Bent parts can cause problems during installation and subsequent use of the printer.

⚠ **Do not modify any parts unless instructed to do so.**

STEP 8 We are here for you!

The screenshot displays a step-by-step assembly guide for a Prusa 3D printer. On the left, a vertical navigation menu lists steps from 3 to 15, with '5. Extruder assembly' selected. The main content area features 'Step 13 Assembling the Nextrunder idler'. It includes a photograph of a hand holding a component, a list of instructions, and a comment section. The instructions are:

- Insert the idler assembly between the PG-ring and the extruder motor. There is a cutout for the spacer in the main-plate. Line up the idler spacer with the hole in the PG-ring.
- Secure both parts with grub screw 3x25. Do not overtighten the screw! The grub screw protrudes from the PG-ring after tightening.
- Apply a small amount of Prusa Lubricant all around the PG-ring and PG-assembly teeth.
- ⌚ Tip: apply a small amount of lubricant to the tip of the zip tie and then spread the lubricant over the gears.
- Using a paper towel, wipe off any excess lubricant on the front surfaces.

Below the instructions is a comment box with a 'SUBMIT' button. To the right, a larger view of the same step shows additional tips and a '2 comments' indicator. A pink arrow points from the 'SUBMIT' button in the comment section to a 'Chat now' button in the bottom right corner.

- Lost in the instructions, missing screw or cracked printed part? **Let us know!**
- You can contact us using the following channels:
 - Using comments under each step.
 - Using our 24/7 live chat here at help.prusa3d.com
 - Writing an email to info@prusa3d.com

STEP 9 Pro tip: inserting the nuts

- 3D printed parts are very precise, however, there still might be a tolerance in the printed part and same goes for the size of the nut.
- Therefore it might happen, that the nut won't fit easily in or might be falling out. Let's see, how to fix it:
 - **Nut won't fit in:** use a screw with a thread along its entire length (typically: M3x10, M3x18) and screw it from the opposite side of the opening. While tightening the screw, the nut will be pulled in. Remove the screw afterwards.
 - **Alternative option:** you can use X-holder tool included in the package. Insert any screw (typically: M3x10 or M3x18) and screw the nut fully on the tip of the thread. Push the nut into the printed part and remove the screw with X-holder.
 - **Nut keeps falling out:** Use a piece of tape to fix the nut temporarily in place, as soon as you insert the screw in, you can remove the tape. Using glue isn't recommended as it can partly reach into the thread and you won't be able to tighten the screw properly.
- Every time we recommend using the "screw pulling technique", you will be reminded with Joe's avatar ;)
- ⓘ Parts in the pictures are used as an example.

STEP 10 View high resolution images

- When you browse the guide on help.prusa3d.com, you can view the original images in high resolution for clarity.
- Just hover your cursor over the image and click the Magnifier button ("View original") in the top left corner.

STEP 11 Important: Electronics protection

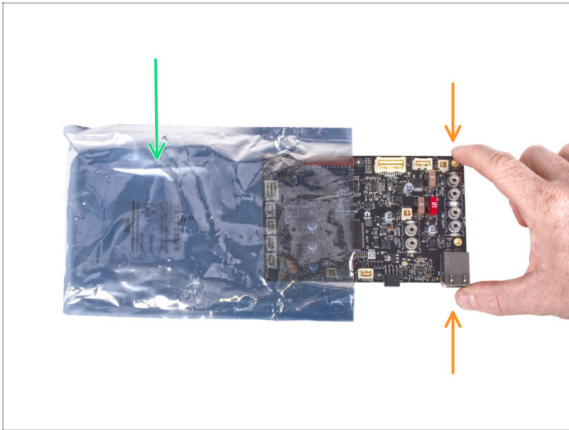

⚠ WARNING: Make sure to **protect the electronics against electrostatic discharge (ESD)**. Always unpack the electronics right before you need them!

● Here are some **tips to prevent damage to the electronics:**

- **Keep the electronics inside the ESD bag** right until you are asked to install them.
- **Always touch the sides of the board only** while handling it. Avoid touching the components on the surface.
- **Before you touch the electronics** use any conductive (metal) structure nearby to neutralize the possible static charge from your hands.
- Be extra cautious **in rooms with carpets**, which are often a source of electrostatic energy.
- Clothes made of wool or certain synthetic fabrics can easily gather static electricity too. It is safer to wear cotton clothing for the assembly.



STEP 12 Reward yourself



- ◆ Based on the feedback, building the MK3.5 printer is even more enjoyable compared to the MK3S+. However, you should still treat yourself for every finished chapter. Look in the box and find bag of Haribo Bears.
- ⚠ **The biggest issue from our experience (MK3S+, MK3S, MK3, MK2S, ...) is inadequate bear consumption. Many of you didn't have enough gummy bears for all chapters, some even ate them all before they started!**
- ◆ After years of thorough scientific research, we came to a solution => At the end of each chapter, you will be told a specific amount of bears to consume.
- ◆ Eating incorrect amount than prescribed in the manual might lead to sudden boost of energy. Please consult a professional in the closest candy store.
- ⚠ **Hide the Haribo for now! From our experience an unattended bag with sweets will suddenly disappear. Confirmed by multiple cases all around the World.**

STEP 13 How to successfully finish the assembly

Step 25 Attaching the spacers

- Insert two M3n nuts to the X-carriage-back.
- ⌚ Use the screw pulling technique.
- From the opposite side, insert the M3x10 screw into the X-carriage-back. The screw must protrude from the "front" side of the part.
- Attach the spacer 10 mm on the M3x10 screw and tighten the screw. **Note the cutout of the same shape as the spacer. It must fit perfectly and must not rotate.**



2 comments

 **To successfully finish the upgrade please follow all these:**

- ◆ **Always read all the instructions at the current step first**, it will help you to understand what you need to do. Don't cut or trim unless you are told to!!!
- ◆ **Don't follow pictures only!** It is not enough, the written instructions are as brief as they could be. **Read them!**
- ◆ Read the comments from the other users, they are a great source of ideas. We read them too and based on your feedback improve the manual and the entire assembly.
- ◆ **Use a reasonable force**, the printed parts are tough, but not unbreakable. If it doesn't fit, check your approach twice.
- ◆ **Most important: Enjoy the build, have fun.** Cooperate with your kids, friends or partners.

STEP 14 Prepare your desk



- ◆ Tidy up your desk! Tidying up decreases the probability of losing small parts.
- ◆ **Clear your workspace.** Make sure you have enough room. A nice clear flat workbench will get you the results you are aiming for.
- ◆ **Let there be light!** Make sure you are in a well-lit environment. Another lamp or even an extra flashlight will probably come in handy.
- ◆ Prepare something to contain the plastic bags and the removed packing materials so you can recycle them afterwards. Make sure there are no important parts being discarded.

2. Parts check

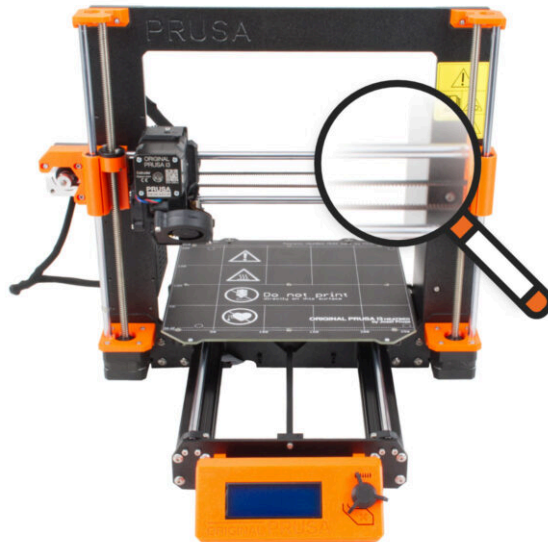

STEP 1 Introduction



- ◆ Some parts on your printer can be used for upgrading, it is essential to check their condition before you start upgrading. This chapter will guide you through the visual inspection of all these parts. If you find a part in poor condition, you have plenty of time to order a new one and continue using the printer in the meantime.
- ⚠ **Do not disassemble or disconnect anything until prompted.**
- ⓘ The following instructions use the MK3S+ printer as an example. **Some parts may be slightly different from previous models.**
- ◆ Any parts that are found to be in poor condition during the inspection can be replaced with new parts. Everything is available in our [eshop](#).
- ⓘ Please note that you have to be logged in to access all parts.

STEP 2 Preparing the printer

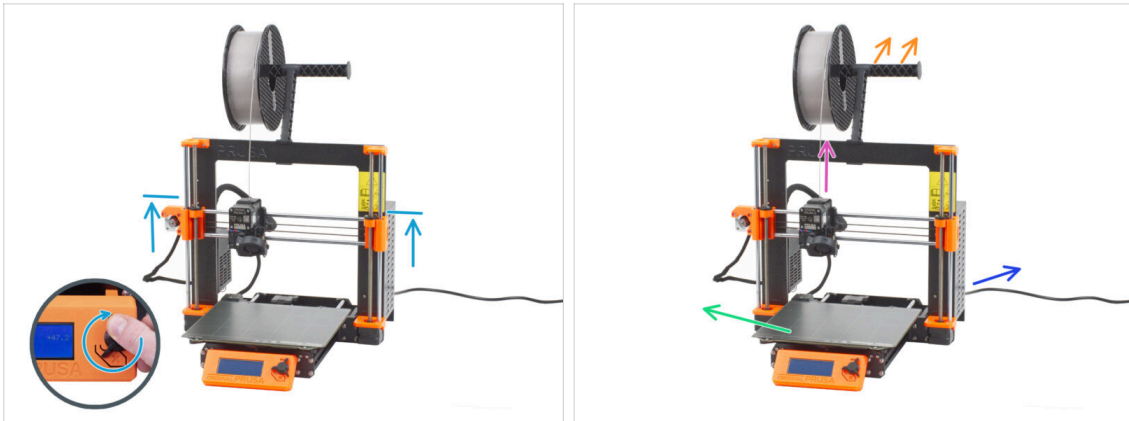

● **Before start handle the printer, make sure that:**

● Z-axis is at least at the top level of the PSU.

ⓘ To access the Z-axis movement menu, you can use the quick shortcut of long holding the knob (1 second), then rotating to move the axis.

● Filament is unloaded from the extruder.

● Spool holder is removed from the printer.

● Print sheet is removed from the heatbed.

● Printer is turned OFF and the power cable is unplugged from the PSU (power supply unit).

STEP 3 Heatbed inspection

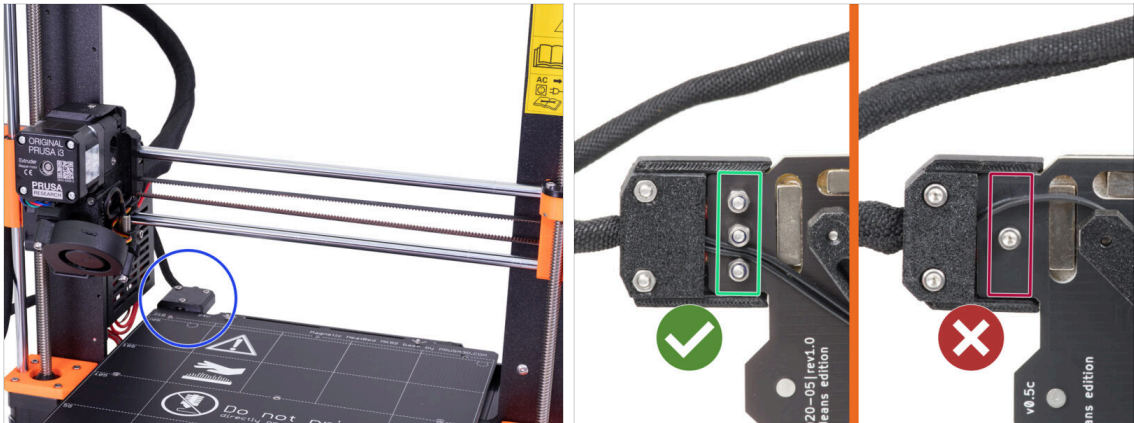

⚠ **The upgrade from MK3S/MK3S+ to MK3.5 is compatible with the heatbed that has screwed power cables.**

- ◆ **From the underside of the heatbed**, take a closer look at the heatbed connector and check what variation you have:
 - **THREE SCREWS** in a row: heatbed with screwed power cables. This variation **is compatible** with the upgrade.
 - ◆ **ONE SCREW**: soldered power cables. This variation is **NOT compatible** with the upgrade. You can buy a compatible version in our [eshop](#)

STEP 4 Heatbed surface inspection



- ◆ Carefully inspect the surface of the heatbed. If you find any major scratches (up to the copper layer) consider replacing it with a new piece.

STEP 5 X-axis smooth rods inspection

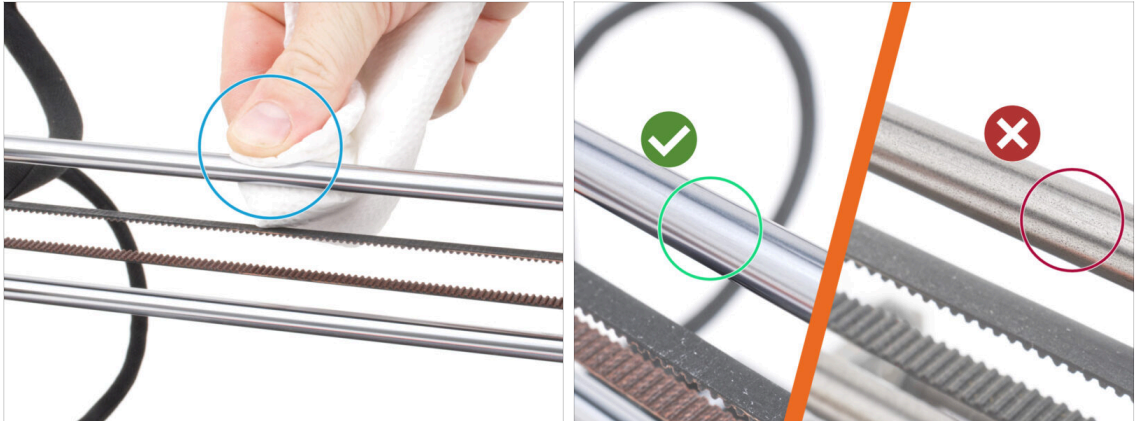

- Wipe the dirt from the entire length of the smooth rods with a paper towel.
- **Carefully inspect the surface of the smooth rods up close.**
 - The surface must be clean, smooth, and without corrosion.
 - If you find a rough scratch, corrosion, or rough surface, it is **highly recommended replacing with a new piece**. Buy a new **Smooth rod X-axis** (8x370 mm) in our [eshop](#)
 - Likewise, if the **smooth rods are scratched or the bearing travel on the rods is not smooth (they really stutter)**, we recommend ordering new **LM8UU bearings** as well. Buy new LM8UU bearings in our [eshop](#).

STEP 6 Y-axis smooth rods inspection

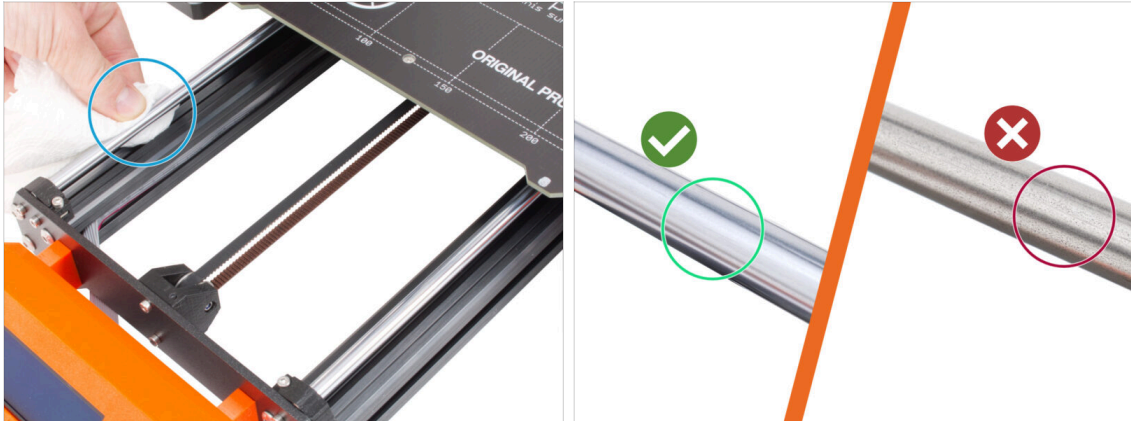

- ◆ Wipe the dirt from the entire length of the smooth rods with a paper towel.
- ◆ **Carefully inspect the surface of the smooth rods up close.**
 - ◆ The surface must be clean, smooth, and without corrosion.
 - ◆ If you find a rough scratch, corrosion, or rough surface, it is **highly recommended replacing with a new piece**. Buy a new **Smooth rod Y-axis (8x330 mm)** in our [eshop](#)
 - ◆ Likewise, if the **smooth rods are scratched or the bearing travel on the rods is not smooth (they really stutter)**, we recommend ordering new **LM8UU bearings** as well. Buy new LM8UU bearings in our [eshop](#).

STEP 7 Printer frame inspection

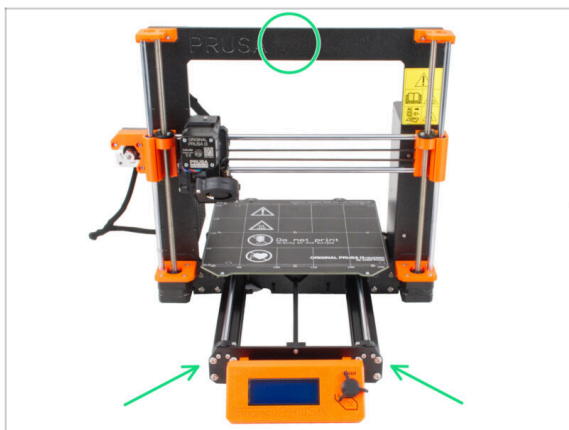

- ◆ Visually inspect all metal parts of the printer frame.
- ⚠ It is highly recommended to **replace a mechanically damaged frame (bent, broken) with a new one**. All parts are available in our [eshop](#).
- ⓘ Any scratches and scuffs are of no significance for the upgrade. In this case, it is up to your discretion to replace the parts.

STEP 8 For new users of black PSU



◆ If you've bought the black 24V 240W PSU, visit the dedicated installation guide here: [How to replace PSU on MK3 printers.](#)

⚠ Don't forget to get back to this manual afterwards.

STEP 9 Can I open the Haribo?



⚠ **Keep the Haribo bag closed for now!**

◆ This dose of energy is primarily for printer assembly. **Wait until you are prompted to open it.**

STEP 10 Let's get started



- ◆ Everything checked? So, let's start with disassembling the printer. Go to the next chapter.

3. Printer disassembly



STEP 1 Disconnecting cables

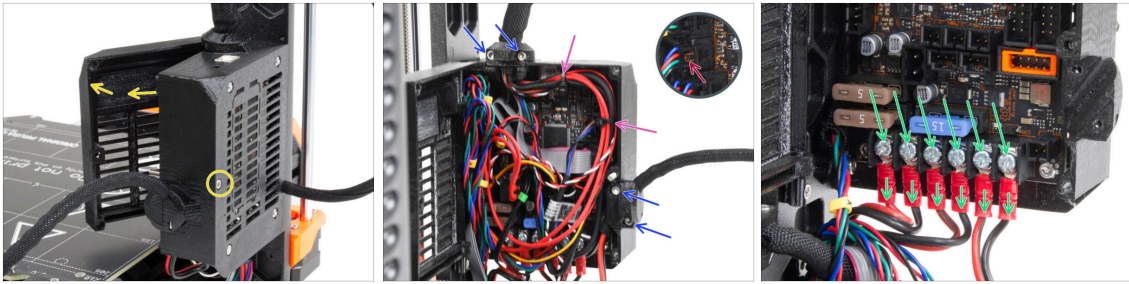

- ◆ Take a look from the back of the printer.
- ◆ On the electronics box (Einsy base), release the middle screw on the box to open the door.
- ◆ Release all M3 screws on the cable holders on the box.
- ⚠ **Avoid cutting the cables!!!**
- ◆ If some of the cables are secure with zip ties, **carefully cut the zip ties**.
- ◆ Disconnect all cables from the EINSY electronics board.
 - ◆ Some of the cables have a safety latch on the connector. Press the latch before disconnecting.
- ◆ Using the Philips screwdriver, loosen all the 6 power terminal screws and slide out all the power cables.

STEP 2 Removing the electronics box



- ◆ Loosen the M3 screw in the bottom of the electronics box fixing the printed case to the frame. No need to remove it at the moment.
- ◆ Loosen the top M3 screw inside the box. Push the 2.5 Allen key through the most top vent opening to reach the screw.
- ◆ Slide out the box to the right side and remove it from the printer.

STEP 3 Removing the einsy-door



- Release and remove all four M3 screws together with the einsy-door.
- i** Most of the following pictures are taken on the latest version of the printer frame. The frame has hexagonal recesses on its back side. This is just a design element. The latest frame design is functionally identical with the previous ones.

STEP 4 Removing the heatbed

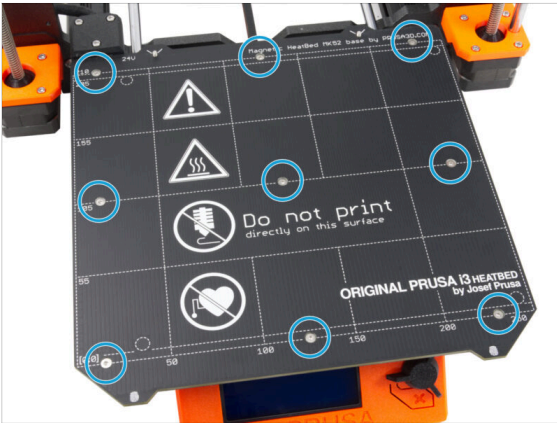

- Release all nine screws securing the heatbed and remove the heatbed from the printer.
- After removing the heatbed, there are nine unattached spacers on the Y-carriage. **Place them in a separate place to avoid confusion with similar parts.** You will no longer need this part.

STEP 5 Removing the heatbed cable cover

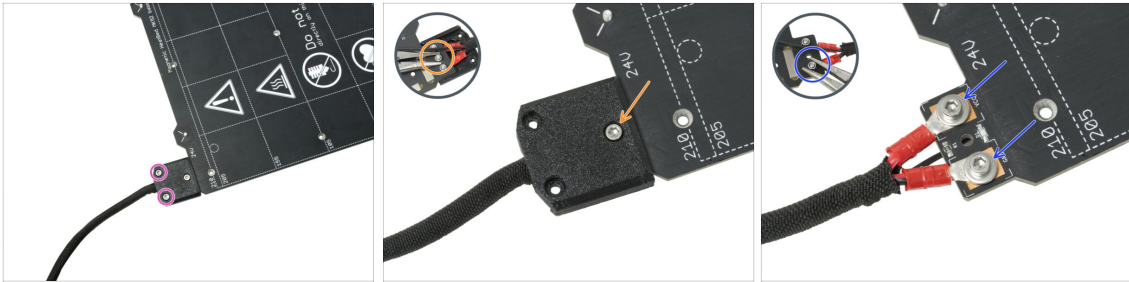

⚠ NOTE: If you have already purchased a new heatbed, you can skip disassembling the old one and go to the next step.

- i** This part may vary slightly in the design of the cover, location of the screws and number of the screws.
- 🟡** Remove the screws fixing the cable bundle.
- 🟠** Remove the screw securing the cover. From the underside, grasp the middle M3nN nut with the pliers while loosening the screw.
- ⬛** Remove the cover.
- 🟢** Release the screws fixing the heatbed power cables and remove the cables from the heatbed. From the underside, grasp the M3nN nuts with the pliers while loosening the screws.

STEP 6 Releasing the cable management

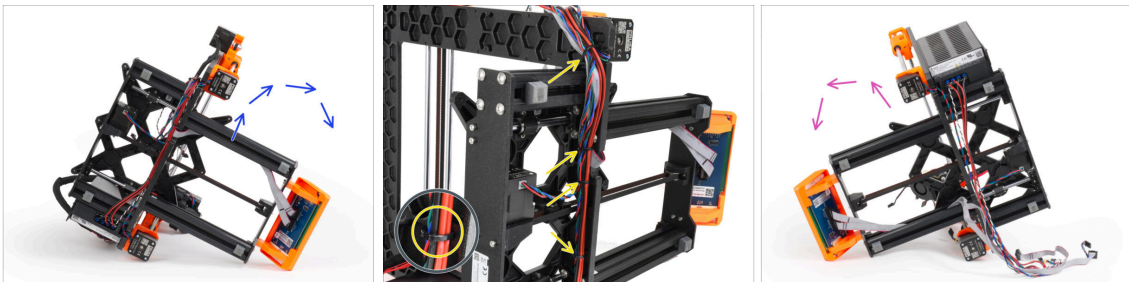

- 🟢** Put the printer on its right side (side with the PSU)
- 🟡** From the top, cut the zip ties securing the cable bundle to the frame.
- ⚠** **Avoid cutting the cables!!!**
- 🟡** Turn the printer on its left side.
- ⚠** **Check the condition of the Y and Z motor cables.** If the zip ties have been too tight for a long time, the cables may be damaged.

STEP 7 Disconnecting the LCD cables



- ◆ Carefully pull out both LCD cables from the extrusion profile.
- ◆ Disconnect the LCD cables from the LCD assembly.

STEP 8 Disconnecting the PSU cables (Black PSU)

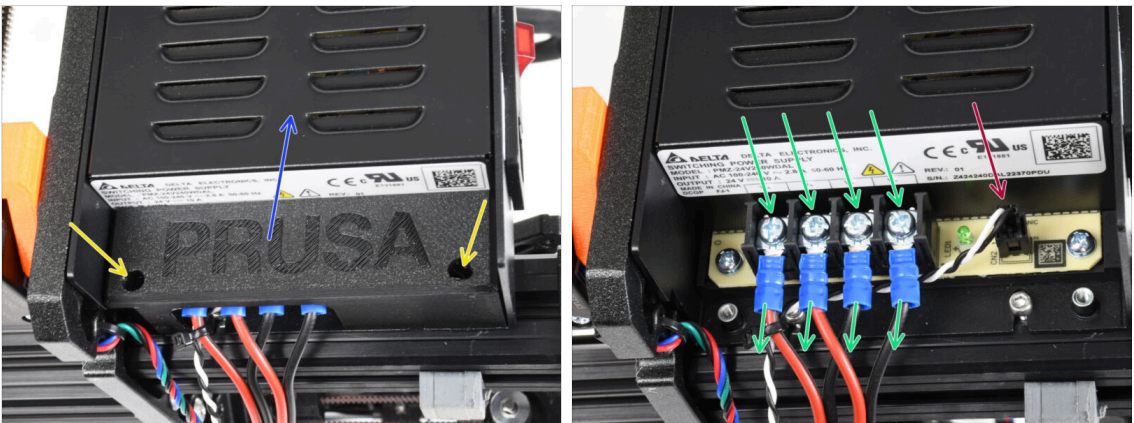

- ⓘ **This step is intended for the black PSU only.** If you have the silver PSU, skip this step.
- ◆ Release the M3 screws inside the PSU-cover.
- ◆ Remove the PSU cover from the printer.
- ◆ **KEEP the PSU-cover aside**, you will need this part for the MK3.5 upgrade.
- ◆ Using the Philips screwdriver, loosen all four terminal screws on the PSU and pull out the power cables.
- ◆ Disconnect the power panic cable.
- ⓘ The power panic connector has a safety latch, that must be pressed before disconnecting.

STEP 9 Removing the LCD assembly

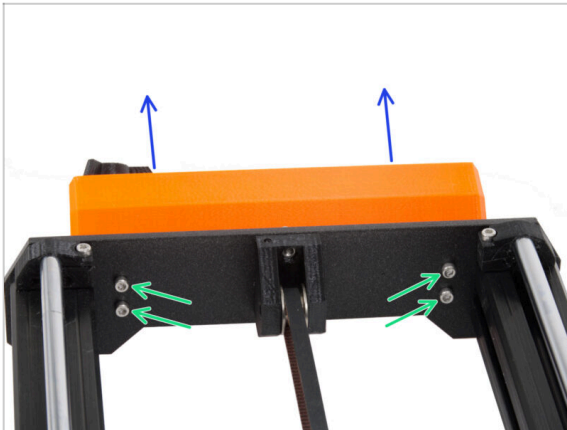

- ◆ Release four M3 screws mounting the LCD assembly to printer.
- ◆ Remove the LCD assembly to the printer.

STEP 10 Still no sweets?



- ◆ **Please don't open the bag yet.**
- ◆ But you are getting close to your first taste ;).

STEP 11 Parts summary



- We have now finished disassembling the printer. Let's see which parts will be used in the following chapters.
- **Prepare the following parts for the next chapters:**
 - Heatbed MK52 24V (1x)
 - PSU-cover (1x) for *Black PSU only*
 - MK3S / MK3S+ printer torso (1x)
- All the **parts you printed for the upgrade.**
- ⓘ Retain the power cord to the PSU, flexible steel sheet(s) and spool holder to use the printer.
- ⚠ **You will no longer need the parts not listed for the upgrade. Keep them aside to avoid mixing with new parts.**

4. xBuddy assembly

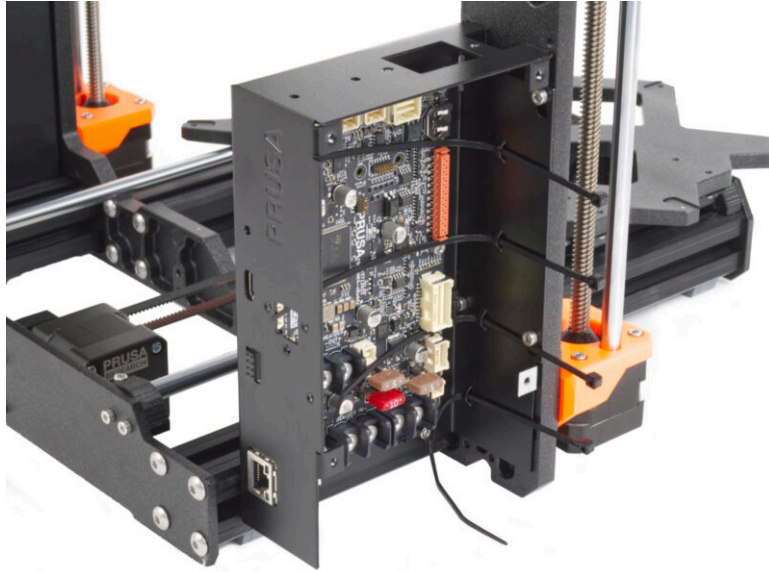

STEP 1 Tools necessary for this chapter

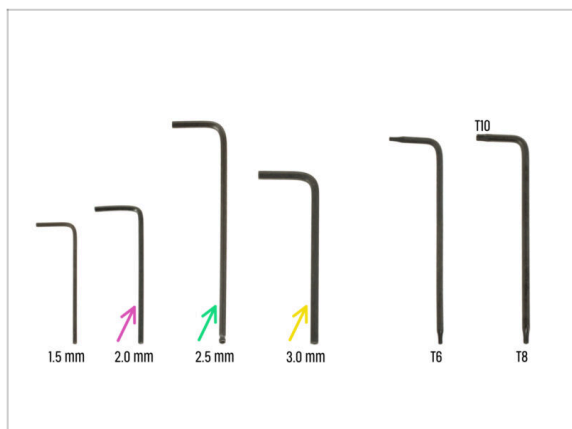

- **For this chapter, please prepare:**
- 2.0mm Allen key for tightening the grub screws
- 2.5mm Allen key for most of the M3 screws on the assembly
- 3mm Allen key for M5 screws used on the frame

STEP 2 xBuddy box: parts preparation I.

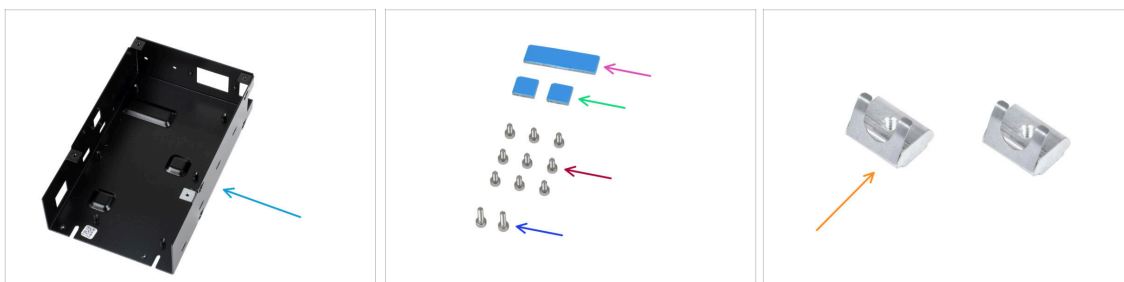

- **For the following steps, please prepare:**
- xBuddy box (1x)
- Thermal pad 40x12x2.2 mm (1x) can be found in Buddy & Extruder assembly bag
- Thermal pad 12x12x2.2 mm (2x) can be found in Buddy & Extruder assembly bag
- M3x6 screw (9x)
- M3x10 screw (2x)
- M3nEs nut (2x)
- **i** The list continues in the next step...

STEP 3 xBuddy box: parts preparation II.

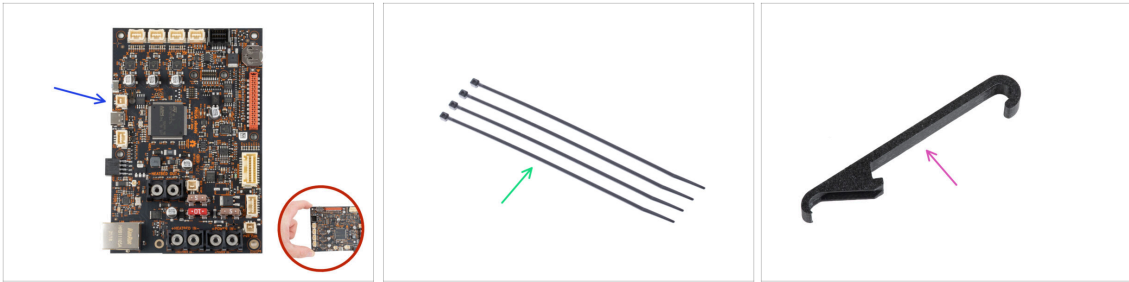

◆ For the following steps, please prepare:

◆ xBuddy board (1x)

⚠ **Always touch the sides of the electronics board while manipulating it. Avoid touching the chips, capacitors and other parts of the electronics.**

◆ Zip tie (4x)

◆ X-holder (1x)

STEP 4 Inserting the M3nEs nuts



◆ Insert the M3nEs nut into the left short extrusion (side without the PSU). Insert the side with the spring (metal plate) first.

◆ Push the entire nut inside the extrusion using your finger.

◆ Use this method for both M3nEs nuts. The exact position of the nuts doesn't matter at this time.

STEP 5 Mounting the xBuddy box



- ◆ Turn the printer so that the **extrusion profiles with shorter lengths are facing towards you**.
 - ⓘ Most of the following pictures are taken on the latest version of the printer frame. The frame has hexagonal recesses on its back side. This is just a design element. The latest frame design is functionally identical with the previous ones.
 - ◆ Insert four M3x6 screws to the back of the frame (side with shorter extrusions), so they resemble a rectangular pattern. Tighten the screws fully into the frame to clean the threads. Then loosen the screws, **leaving a gap of at least 3 mm between the screw head and the frame**.
 - ⚠ **Make sure you are using the correct holes.**
 - ◆ Insert two M3x10 screws into the M3nE nuts in the second short extrusion (right from the rear view). Turn them only 3-4 times by using a 2.5mm Allen key, just for the screws to be kept in place.

STEP 6 Mounting the xBuddy box

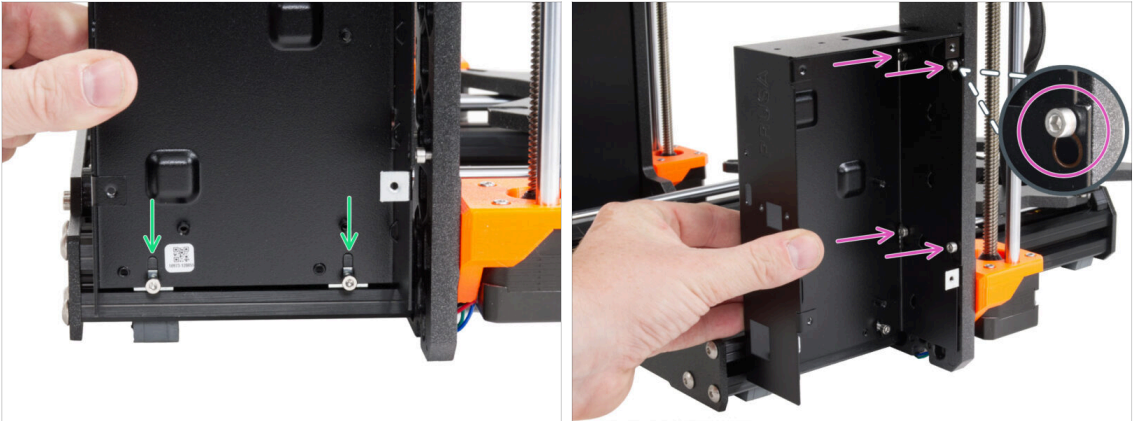

- Attach the xBuddy box on the M3x10 screws in the extrusion. **Do not tighten the screws at the moment!**
- Slide the xBuddy box to the frame and attach the box to all 4 screws in the frame. The screws must fit into the top part of the "key" hole. See the detail.

STEP 7 Mounting the xBuddy box

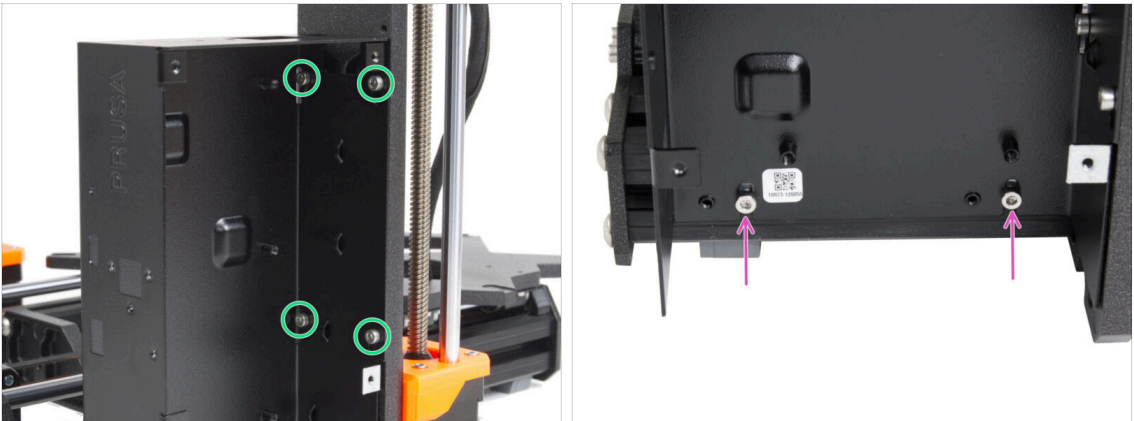

- Fully tighten all four M3x6 screws to secure the xBuddy box.
- i** Be careful when tightening the "rear" top screw. Use the shorter side of the Allen key for final tightening.
- Fully tighten both M3x10 screws in the M3nE nuts.

STEP 8 Applying the thermal pads

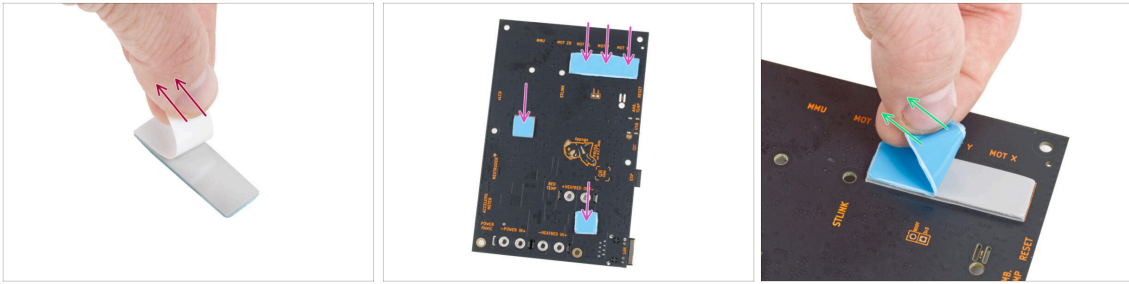

- ◆ Peel off the white protective layer from all thermal pads.
 - ⚠ **Always touch the sides of the electronics board while manipulating it. Avoid touching the chips, capacitors and other parts of the electronics.**
- ◆ Attach the pads onto the back of the xBuddy board. There are markings that indicate the correct size and positions.
 - ⓘ The surface to which the pads are stuck must be cleaned of grease. This will ensure better adhesion.
 - ⚠ For the protection of the board's electronic components, we strongly recommend placing the xBuddy board on the soft pad. You can use the original xBuddy bubble wrap package.
- ◆ Peel off the blue protective layer from all thermal pads.

STEP 9 Mounting the xBuddy board

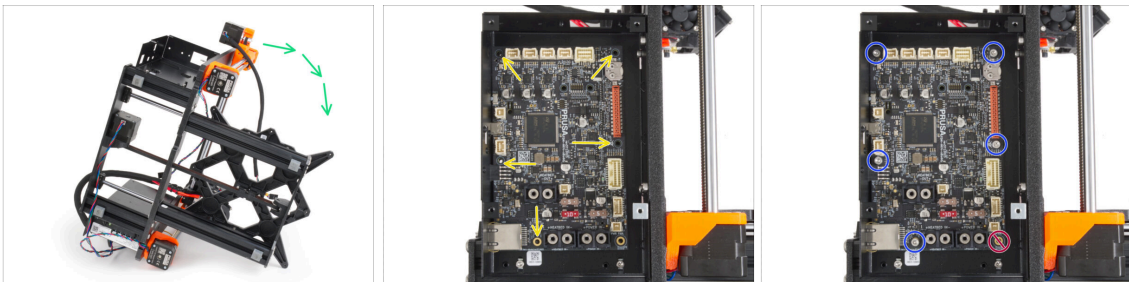

- ◆ For better access to the xBuddy box, carefully place the frame on the side with the PSU.
- ◆ Insert the xBuddy board into the xBuddy box. **Before fully attaching it completely, center the holes** in the board with the holes (columns) in the xBuddy box
- ◆ Fix the position of the xBuddy board by inserting **five M3x6 screws**. **Do not fully tighten the screws**. A few turns are enough for now.
 - ⚠ **Put aside your instinct and leave the hole on the bottom right empty.**
- ◆ Fully tighten all five screws. **But very carefully**, otherwise you can damage the electronics board.

STEP 10 Attaching the zip ties

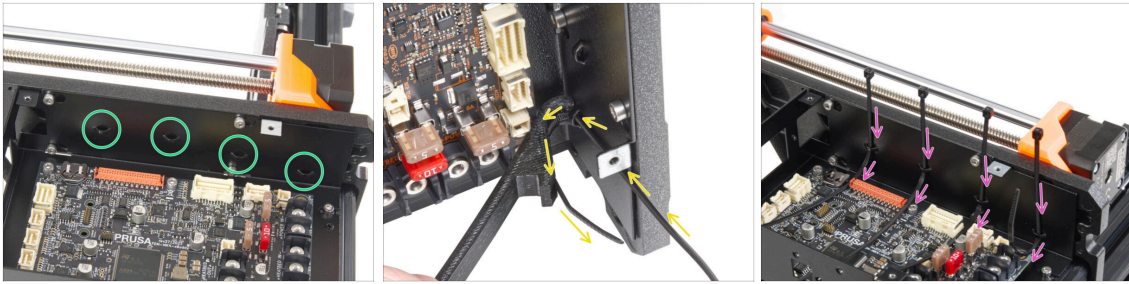

- ◆ Take a closer look at to the xBuddy box. There are four perforations on the metal case.
- ⓘ You can place the frame on the PSU side for better access to the xBuddy box.
- ⚠ **Proceed very carefully. Be careful not to damage the connectors or capacitors on the xBuddy board.**
- ◆ Use the X-holder as a zip tie guidance. Place the X-holder behind the lowest perforation like in the picture. Push the zip tie through the protrusion to the X-holder. Keep protruding 3 - 5 cm of the zip tie from the perforation.
 - ⚠ **Note the correct orientation of the zip tie. The teeth on the zip tie must be on the visible side.**
- ◆ Use this procedure for all four protrusions.
- Place the printer back on its "feet".

STEP 11 Haribo

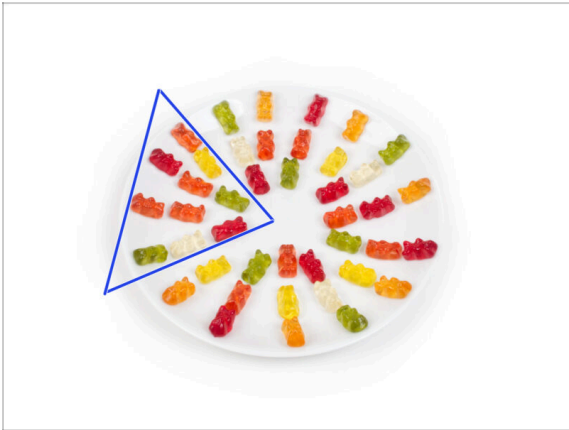

⚠ Carefully and quietly open the bag with the Haribo sweets. High level of noise might attract nearby predators!

- Spread the entire contents of the bag on a clean plate and arrange them according to the picture. The color doesn't matter that much.
- ⓘ The total number in your package may vary slightly. However, the exact number is important. If any gummy bears are missing, please go to your nearest candy store immediately.
- Eat ten gummy bears.
- ⓘ **Did you know that** gummy bears were first created by a German candy maker named Hans Riegel in the 1920s.

STEP 12 It's done

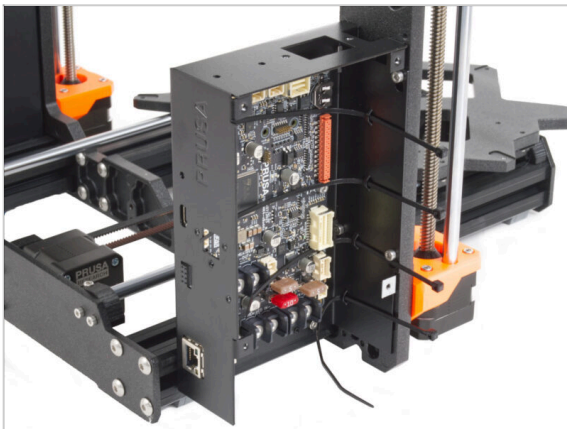

- The xBuddy box is successfully assembled and mounted to the printer.
- Let's go to the next chapter 5. xLCD & PSU assembly

5. xLCD & PSU assembly

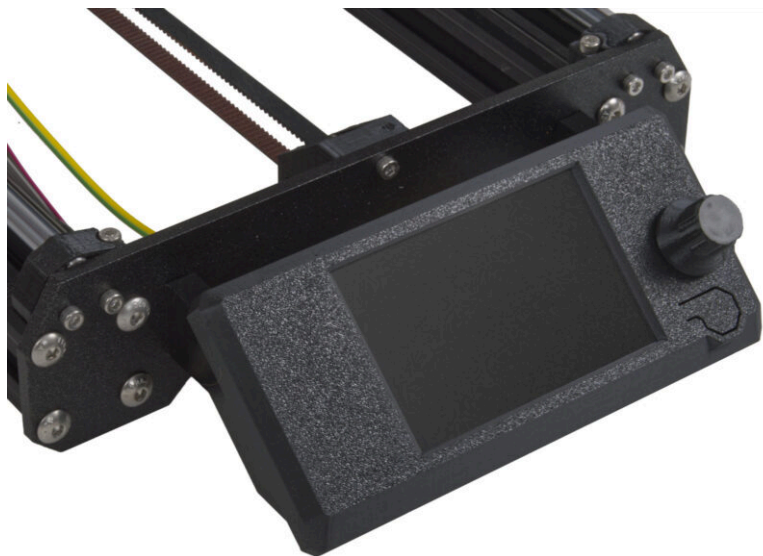

STEP 1 Tools necessary for this chapter

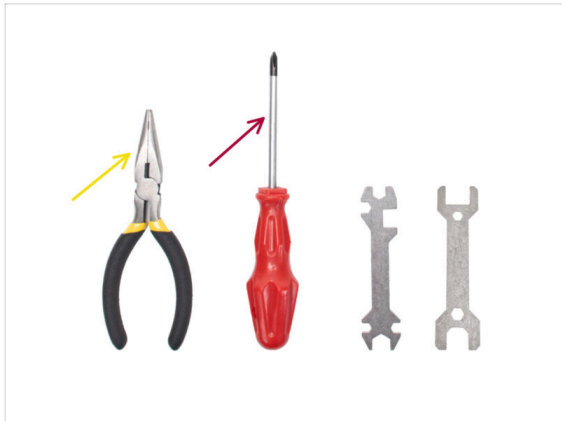
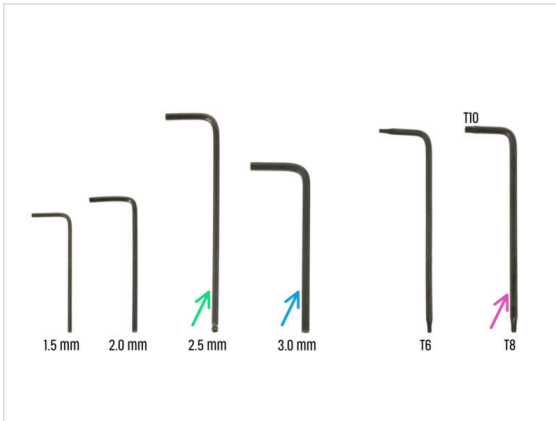

● For the following steps, please prepare:

- 2.5mm Allen key
- 3.0mm Allen key *for silver PSU version*
- Needle-nose pliers for tightening and cutting zip ties
- Torx key T8/10
- Phillips screwdriver

STEP 2 Cable clips: parts preparation



● For the following steps, please prepare:

- Cable clip (6x)

STEP 3 Installing the cable clips

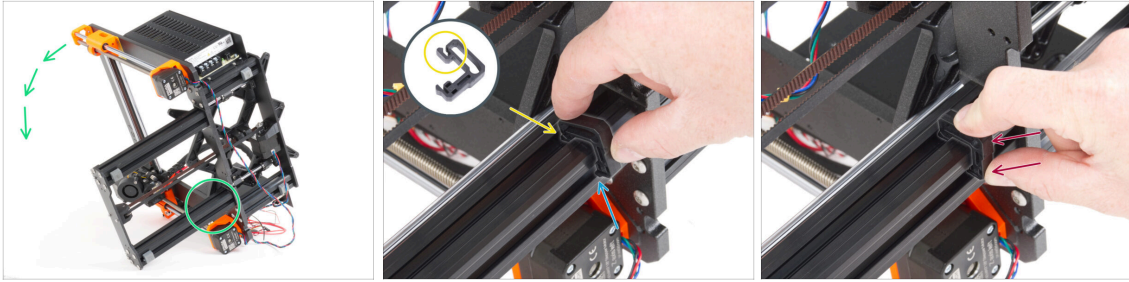

- ◆ Turn the frame like in the picture and focus on the marked area.
- ◆ Take one of the cable clips and hook the side with the clip into the inner groove of the lower longer extrusion. There is a hook on the part, see the detail.
- ◆ Place the other end of the clip on the underside of the extrusion.
- ◆ Use more force to push on the bottom side of the cable clip. It must fit into the groove and you must feel it "click" in.

STEP 4 Installing the cable clips

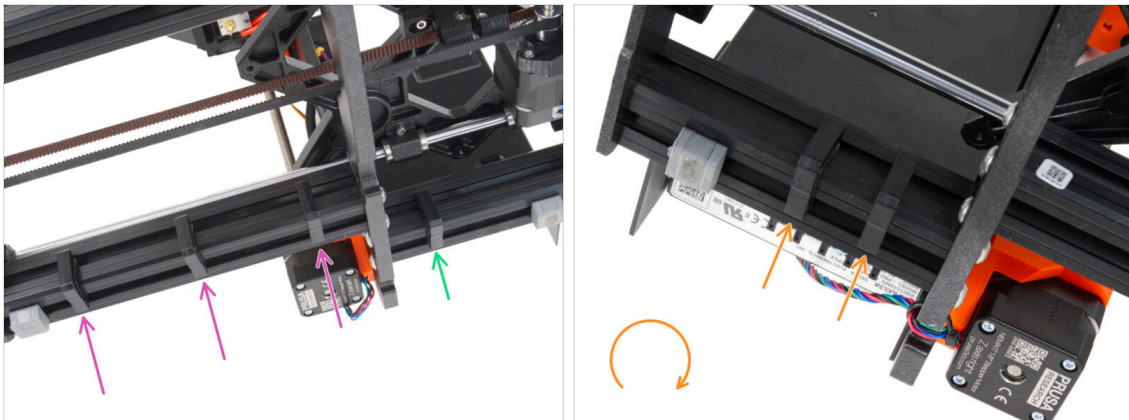

- ◆ Install three clips to the long extrusion.
- ◆ Install one clip to the short extrusion.
- ◆ Turn the frame, install two clips to the second short extrusion.
- ◆ Place the printer back on its feet.

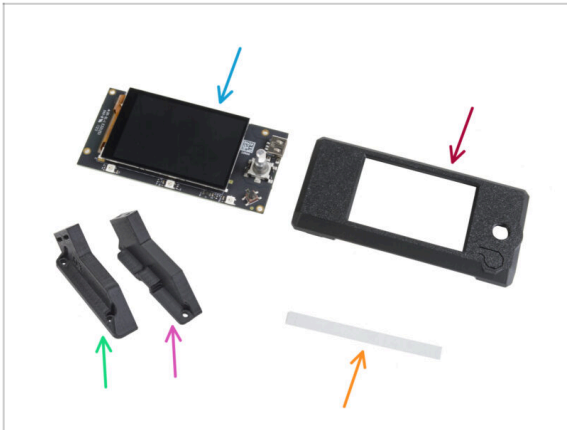
STEP 5 xLCD assembly: parts preparation

◆ For the following steps, please prepare:

◆ xLCD (1x)

⚠ Remove the protective film from the xLCD screen.

◆ xLCD-cover (1x)

◆ xLCD-support-left (1x)

◆ xLCD-support-right (1x)

◆ xReflector sticker set (1x)

ⓘ The list continues in the next step...

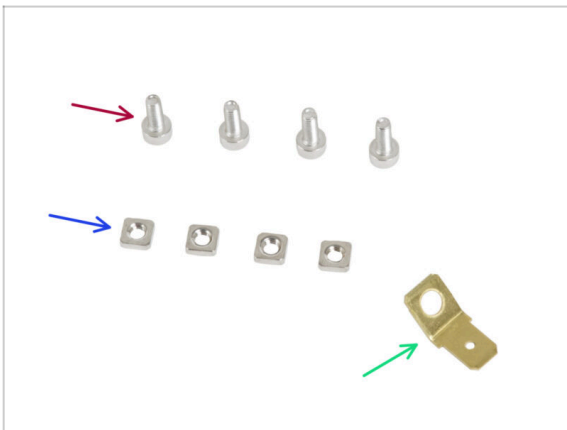
STEP 6 xLCD assembly: parts preparation (part 2)

◆ M3x8 screw (4x)

◆ M3nS nut (4x)

◆ PE Faston 6.3x0.8 (1x)

ⓘ In some following steps, you may notice photos of the xLCD-cover with imprinted graphics (MK4 logo, reset button). This is because we have used the identical steps and photos from the MK4 assembly instructions.

STEP 7 xLCD assembly: inserting the square nuts

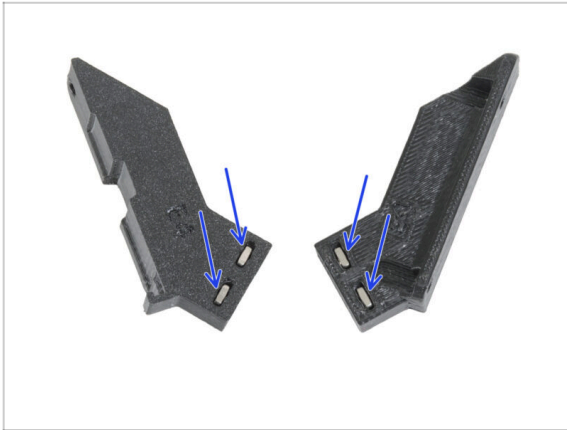

- ◆ Insert two M3nS nuts into the xLCD-support-left and xLCD-support-right.

STEP 8 Installing the xReflector sticker



- ◆ Peel off one of the individual adhesive xReflector sticker.
 - ⓘ If the sticker is damaged during peeling, there is an extra sticker in the SPARE package.
- ◆ Position the xReflector sticker strip so that it lines up with one side and both the edges of the "gutter" in the xLCD-cover. Continue to lay down the xReflector sticker strip towards the other side of the gutter.
- ◆ Press the xReflector sticker strip all the way into the gutter so it adheres to the xlcd-cover.

STEP 9 Assembling the xLCD-support-right

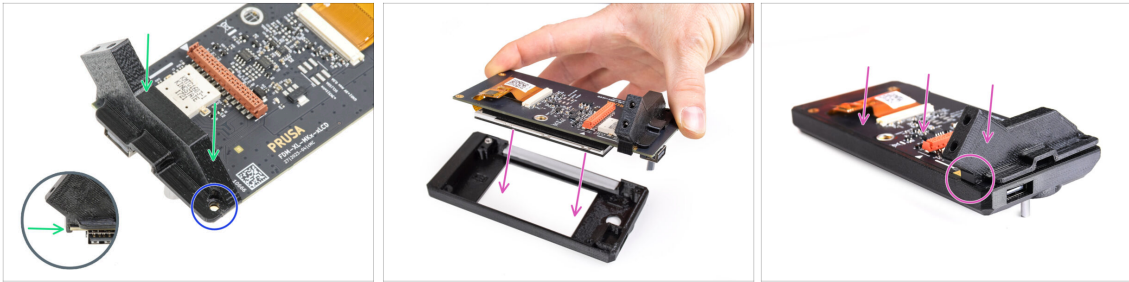

- ◆ Place the xLCD-support-right onto the USB-connector-side of the xLCD board. Notice there is a small hook that goes around the circuit board.
- ◆ Line up the hole in the plastic part with the hole in the xLCD board.
- ⚠ **Ensure that the protective film is removed from the display.**
- ◆ Insert the xLCD with the xLCD-support-right still hooked on, into the xLCD-cover. Note the recess for the xLCD-support-right in the xLCD-cover. The support must perfectly fit into the recess.
- ⓘ Make sure the hook on the xLCD-support-right holds onto the xLCD now. Otherwise, you won't be able to attach it later.

STEP 10 Installing the PE Faston

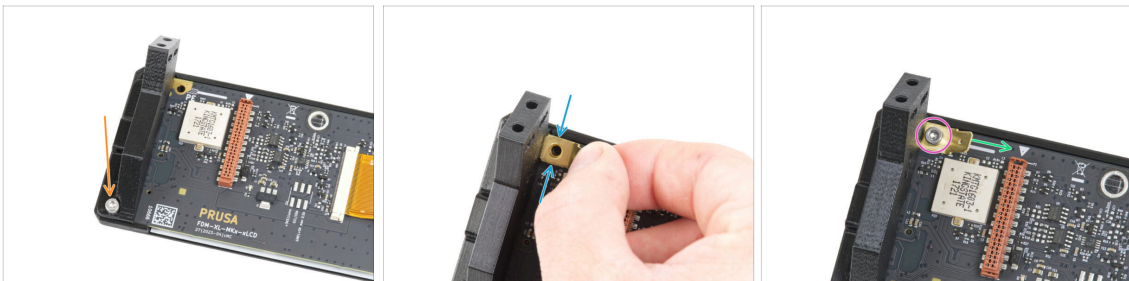

- ◆ Secure the xLCD-support-right and the xLCD board with the M3x8 screw.
- ◆ Attach the PE Faston on the top left hole in the xLCD.
- ◆ Orient PE Faston according to the picture. The bent part must point to the right - to the triangle symbol.
- ◆ Maintain the position and secure the PE Faston with the M3x8 screw.

STEP 11 Assembling the xLCD-support-left

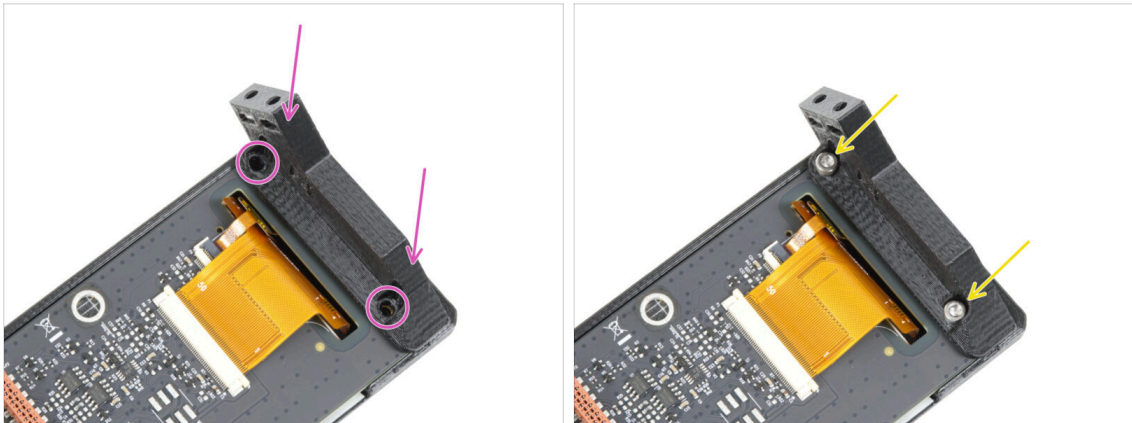

- Attach the xLCD-support-left on the xLCD board and align it with two holes in the board.
- Secure both parts together with two M3x8 screws.

STEP 12 xLCD cables: parts preparation

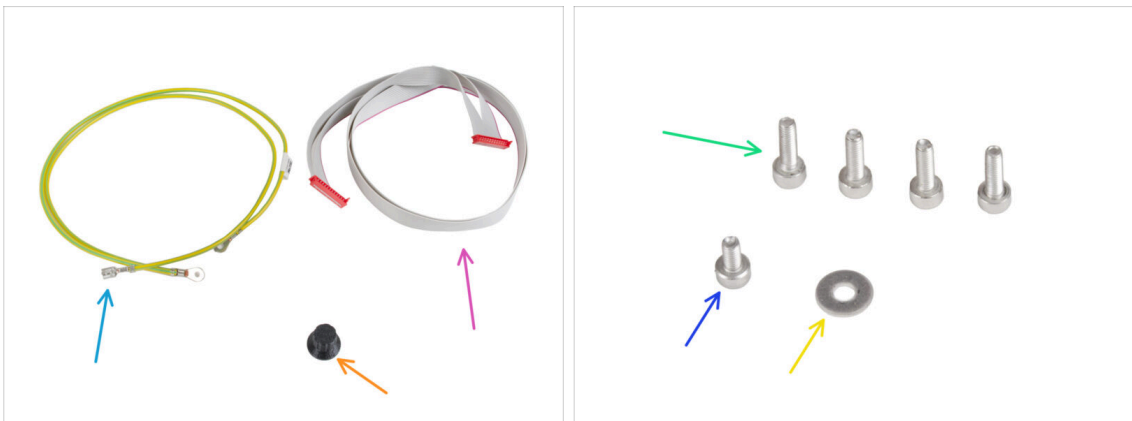

- ◆ **For the following steps, please prepare:**
- ◆ PE cable 460/420 mm (1x)
- ◆ xLCD cable (1x)
- ◆ xLCD-knob(1x)
- ◆ M3x10 screw (4x)
- ◆ M3x6 screw (1x)
- ◆ M3w washer (1x)

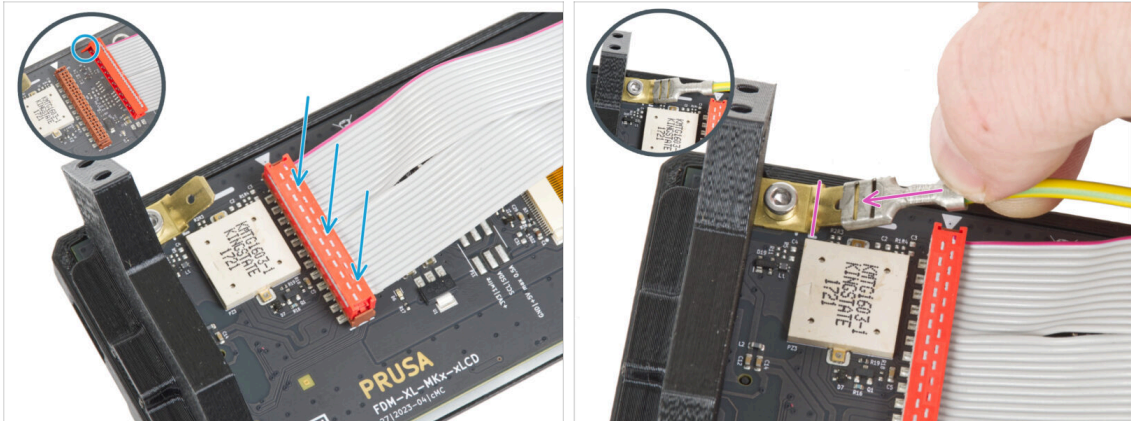
STEP 13 Connecting the PE cable: xLCD

- ◆ Connect the xLCD cable to the xLCD board. Note the safety latch on the xLCD cable connector. It must be plugged into the side of the xLCD slot marked with the triangle symbol on the board.
- ⚠ **Make sure the xLCD cable is connected in the same orientation as seen in the picture. Otherwise, your display won't work**
- ◆ Take the end of the PE cable with square connector. Slide the connector onto the PE Faston all the way down.

STEP 14 Attaching the knob

- ◆ Attach and push the xLCD-knob onto the xLCD encoder pin.
- ⓘ Note that there is a flat part on the encoder shaft. There is a geometry on the inside of the knob that should align with the flat part to seat the knob properly.

STEP 15 Attaching the xLCD assembly

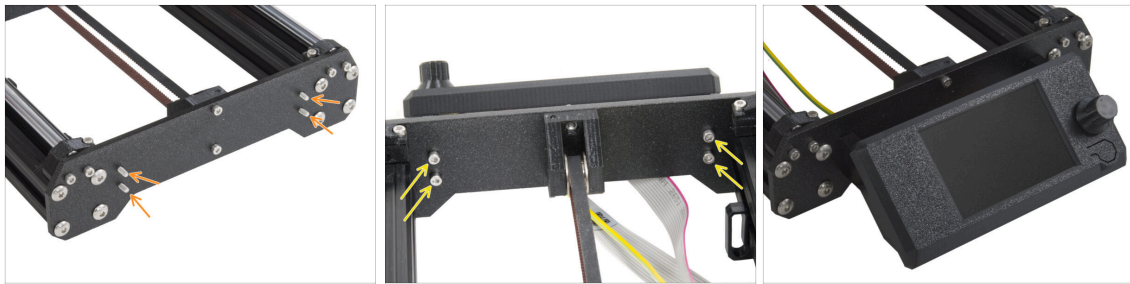

- There are four holes in the front plate of the printer's frame. Insert four M3x10 screws through each of them from the inner side.
- Attach the xLCD assembly onto the front plate. The screws should fit into the corresponding openings in the xLCD assembly.
- Guide the xLCD and PE cables under the front plate to the frame.
- Tighten up all four screws.

STEP 16 Guiding the xLCD cable

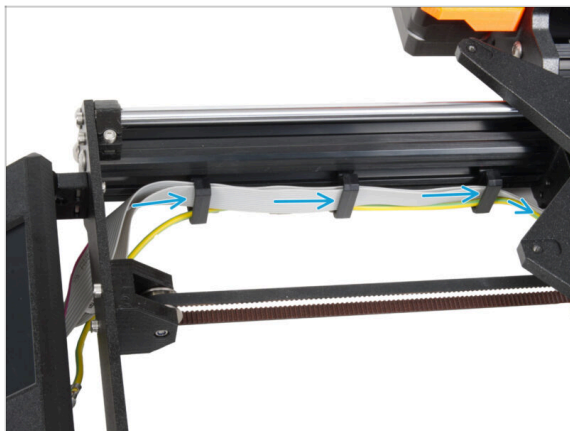

- Guide all cables through the cable clips on the inside of the frame.
- Leave the end of the cable free for now.

STEP 17 Connecting the PE cable: xBuddy

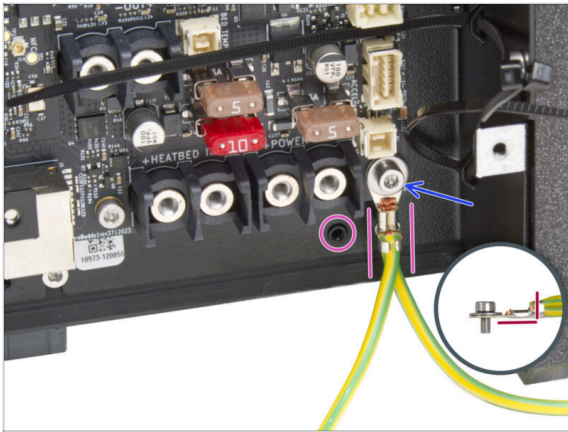

- ◆ Attach the PE cable connector (split end) to the right lower screw hole in the xBuddy box. Secure the cable with the M3w washer and the M3x6 screw. Tighten the screw firmly.
- ⚠ Note the correct orientation of the PE connector.
- ◆ Guide the PE cable so that it does not interfere with the threaded hole under the xBuddy board.

STEP 18 Black vs Silver PSU

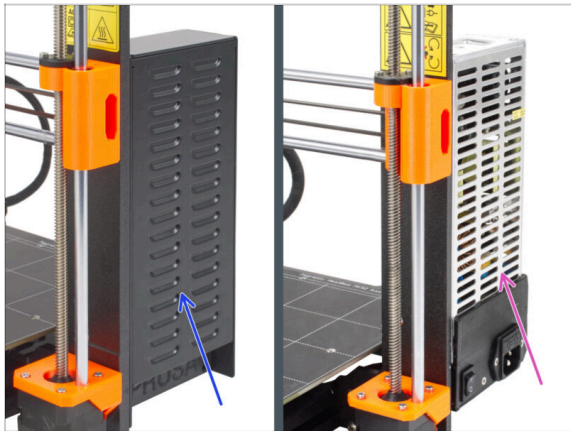

- ⚠ The following instructions vary depending on the type of your PSU (power supply unit)!
- ◆ Select the appropriate instructions for your PSU before proceeding:
 - ◆ **Black PSU** - go to [PSU cables \(black PSU\): parts preparation](#) and follow the instructions.
 - ◆ **Silver PSU** - go to [PSU - PE cable \(Silver PSU\): parts preparation](#) and follow the instructions.

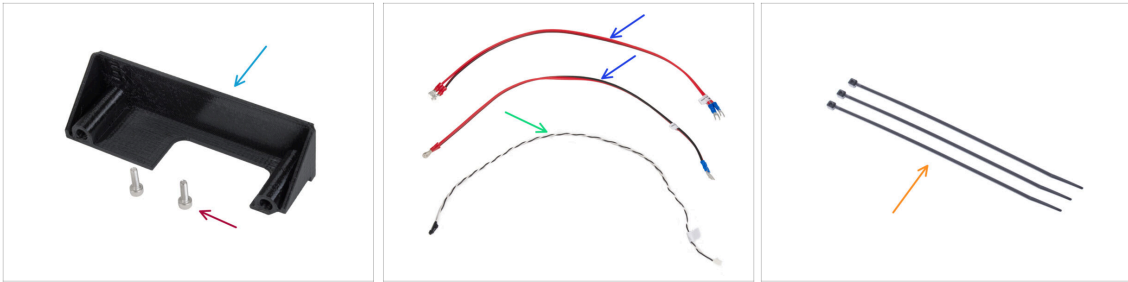
STEP 19 PSU cables (black PSU): parts preparation

i The following steps are intended for the **black PSU** only.

For the following steps, please prepare:

- PSU-cover (1x) *you can retain the old one*
- M3x10 screw (2x)
- xBuddy power cable (2x)
- Power panic cable (1x)
- Zip tie (3x)

STEP 20 Connecting the PSU (Black PSU): PE cable

- Place the printer so that you have easy access to the bottom side of the PSU.
- Remove the left screw on the PSU circuit board. Note there is a washer on the screw. Do not throw the screw away, you will need it later.
- Place the single end of the PE (not the forked end) cable into the same place you have removed the screw. Secure the cable by re-using the screw together with the washer.
- ⚠ **Note the correct orientation of the PE cable connector.**
- Guide the PE cable so that it does not interfere with the threaded column under the PE connector.

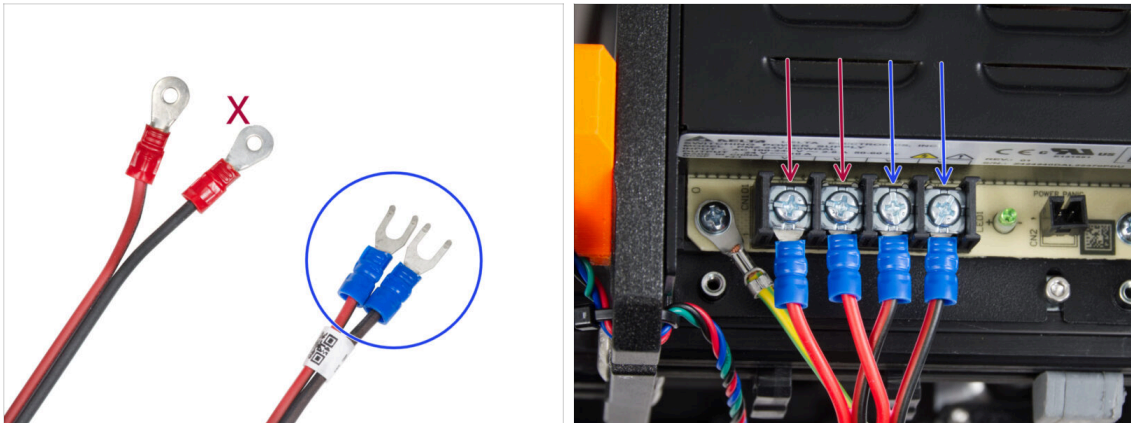
STEP 21 Power cables info (Black PSU)

- i** In the following steps, we will be connecting the power cables one by one. The terminal screws are installed on the PSU already. Loosen them but **don't remove them completely** so they don't get mixed up with the other type of screws used on the xBuddy board side of the cable. Each of the two power cables has two leads. One has a prevailing **red color = positive / +**
One has a prevailing **black color = negative / -**
- ◆** Note that the power cables have different connectors on each end. For now, prepare the U-shaped connectors (crimping tube color may vary).
- ◆** **Note that the polarity of the terminals on the PSU is:**

 - ◆** Positive (V+)
 - ◆** Positive (V+)
 - ◆** Negative (-)
 - ◆** Negative (-)
- i** The red cable (positive) may have a black stripe on it. Similarly, the black cable (negative) can have a red stripe on it.
- ⚠** **Do not connect any cables yet, wait until you have prompted.**

STEP 22 Connecting the PSU (Black PSU)

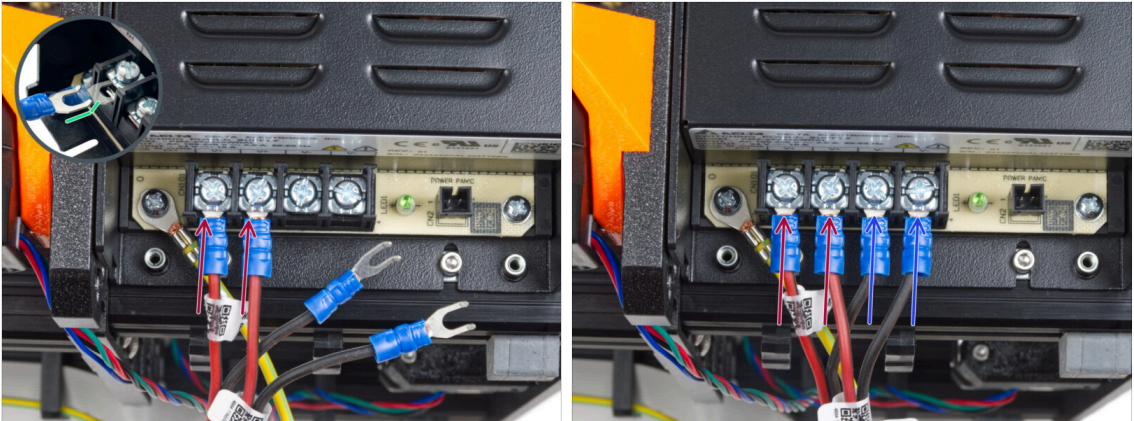

- Take two **RED** wires and slide the fork connectors all the way into the first two (positive) terminals from the left on the bottom of the PSU. Make sure the steel washer is above the "fork" connector.
 - Point the bent part of the fork upwards.
- Tighten the terminal screw firmly.
- ⓘ Keep in mind some parts are made out of plastic. When tightening each of the terminal screws, proceed carefully.
- Take the **BLACK** wires and slide them all the way into the last two (negative) terminals. Make sure the steel washer is above the "fork" connector.
- Tighten the terminal screw firmly.
- ⚠ **Check all the connections again!** The red wire is in the first slot and black in the third. Make sure that cables are tightened properly. Otherwise, there is a risk of a damage to the printer and its surroundings!

STEP 23 Connecting the power panic (Black PSU)



- ◆ Connect the power panic cable into the PSU. Use the side with the black connector at the end.
- ⚠ **Check all the connections again!** The red wire is in the second slot and black in the fourth. Make sure that all the cables are properly tightened. Otherwise, there is a risk of damage to the printer and its surroundings.
- ◆ Place the psu cover over the power terminals. Make sure the "PRUSA" logo is facing upwards.
- ◆ Attach the cover by using the two M3x10 screws through the marked openings. Note the openings are quite deep.
- ⚠ **Make sure the cover is seated properly and no cable is being pinched underneath.**
- ◆ Take a look from the bottom of the PSU and guide all the PSU cables through the cable clips according to the picture.
- ⚠ **Do not guide the Z motor through the cable clips.**

STEP 24 Guiding the power cable bundle (Black PSU)

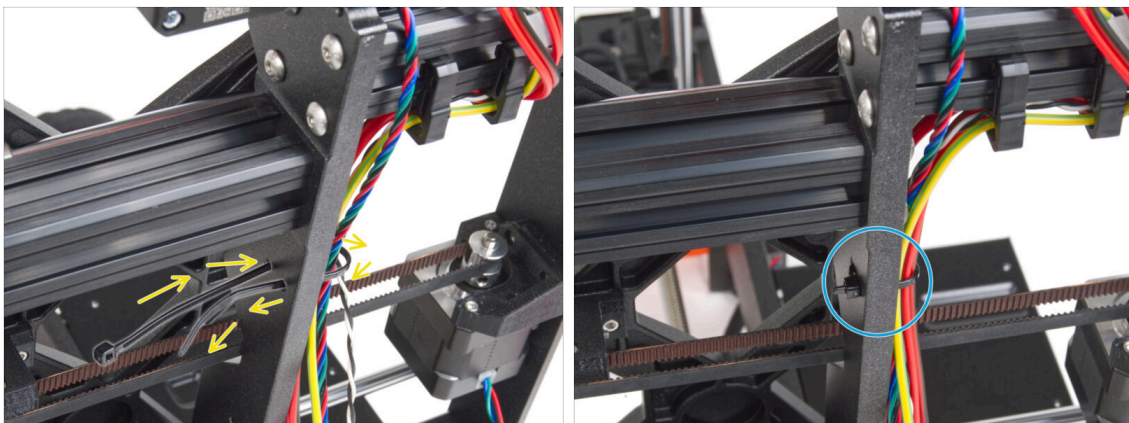

- ◆ Slide the zip tie through the circular holes in the frame to create a loop on both sides of the frame so that the cable goes through both loops.
- ◆ Start tightening the zip tie so it is snug and holds the wires on both sides.
- ⚠ **Be careful not to over-tighten the zip tie as it could damage the wires.**
- ◆ Cut off the remaining part of the zip tie very carefully.

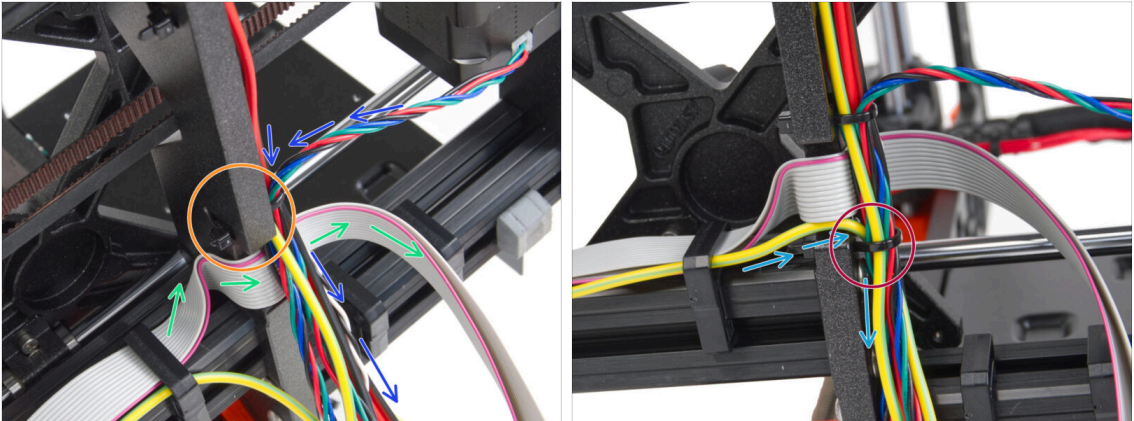
STEP 25 Guiding the power cable bundle (Black PSU)

- ◆ Continue guiding the cables toward the xBuddy. Include the Y motor cable into the bundle.
- ◆ Secure it with another zip tie to the frame.
- ◆ Carefully guide and fold the xLCD cable under the cable bundle. **Do not include the xLCD cable in the cable bundle.** Guide it under the cable bundle and leave it free for now.
- ◆ Guide the PE cable from the xLCD through the cutout in the frame and include it in the cable bundle.
- ◆ Secure the cable bundle with the zip tie.

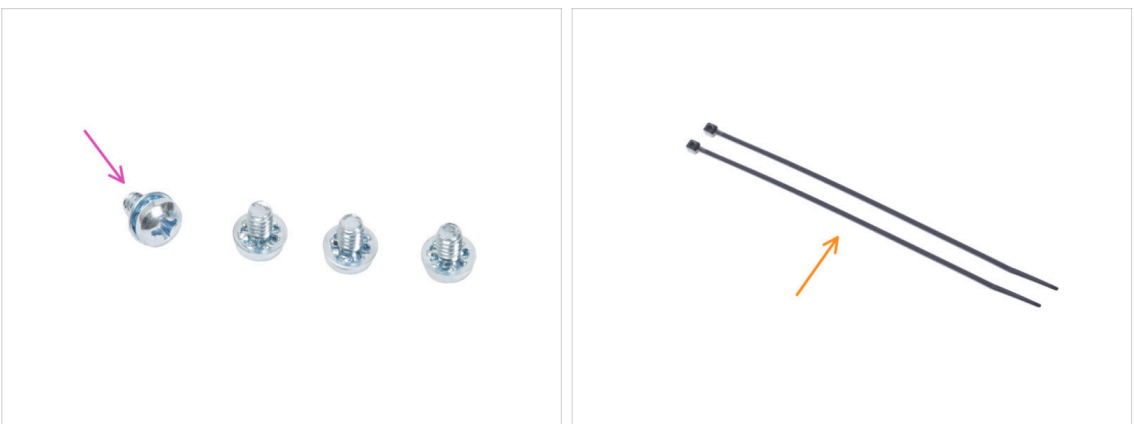
STEP 26 Connecting the PSU cable (Black PSU): parts preparation

- ◆ **For the following steps, please prepare:**
- ◆ Power terminal screw 6-32 (4x)
- ◆ Zip tie (2x)

STEP 27 Guiding the PSU cables (Black PSU): PE cable

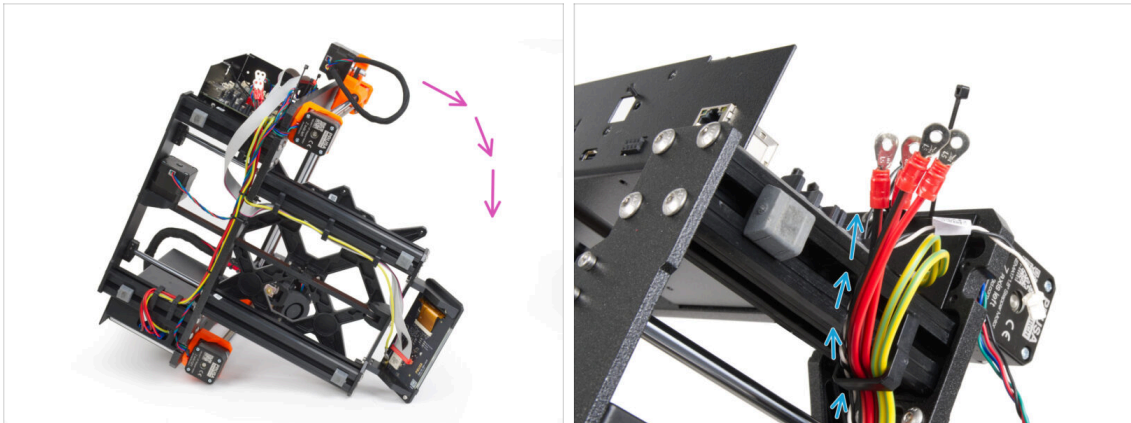

- ◆ Turn the printer on its right side (side with the PSU).
- ◆ Guide all cables **from the PSU** through the cable-clip.

STEP 28 Connecting the PSU cables (Black PSU): PE cable

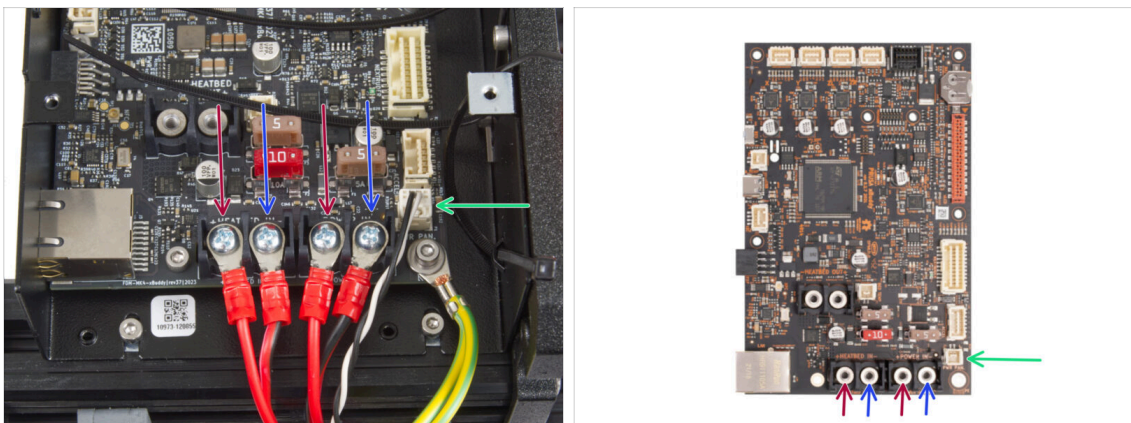

- ◆ **Connect the PSU cables into the xBuddy board in this order (starting from the left with the first pair of the PSU cables):**
 - ◆ Red power cable (positive) *or just the red stripe on the black cable*
 - ◆ Black power cable (negative)
 - ◆ Red power cable (positive) *or just the red stripe on the black cable*
 - ◆ Black power cable (negative)
- ◆ Secure all power cable connectors with the terminal screws. **Tighten the screws gently but firmly.**
- ◆ Connect the power panic cable to the white connector on the bottom of the xBuddy board.
- ⚠ **Verify the correct placement of the cables comparing it to the picture. This is crucial! Incorrect wiring may cause damage to your printer!**
- ◆ Now, skip to **Securing the PSU cables.**

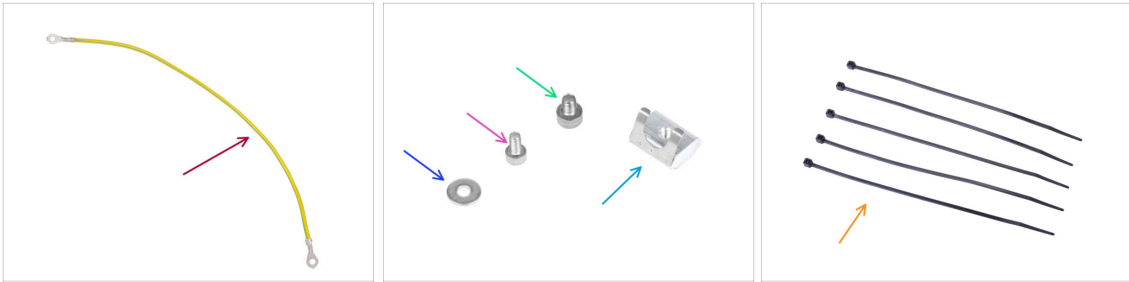
STEP 29 PSU - PE cable (Silver PSU): parts preparation

i The following steps are intended for the **silver PSU** only.

For the following steps, please prepare:

- PE cable extension (1x)
- M3w washer (1x)
- M3x6 screw (1x)
- M4x5 screw (1x)
- M3nEs nut (1x)
- Zip tie (5x)

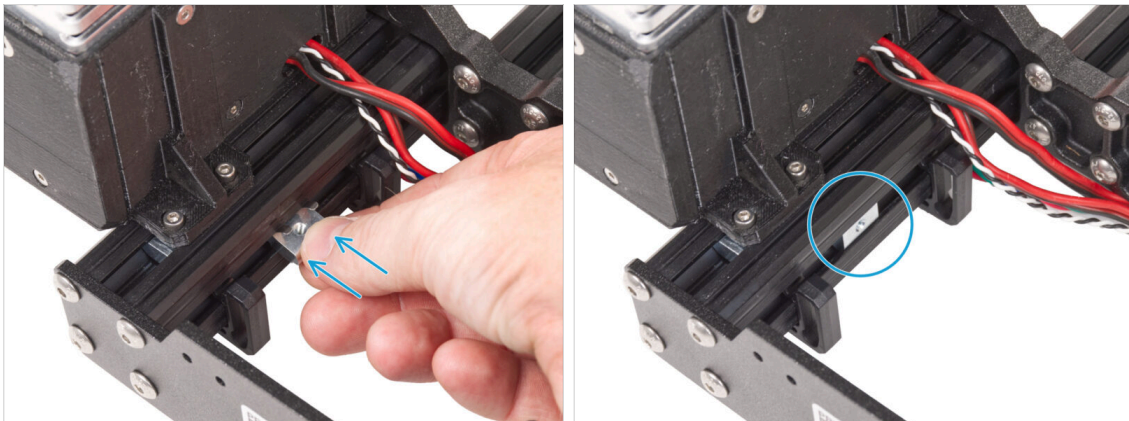
STEP 30 Inserting M3nEs nut (Silver PSU)

📌 The following steps are taken from another printer upgrade guide. Therefore, parts such as the Y-carriage are missing. However, this does not have any effect on the silver PSU connection process.

- From the inner PSU side of the short extrusion, insert the M3nEs nut between two cable clips.

i The exact position of the nut doesn't matter.

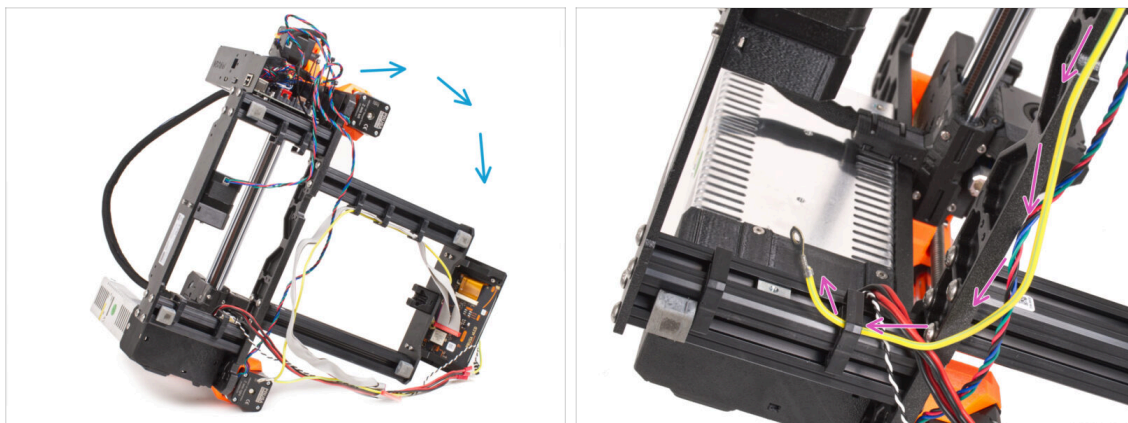
STEP 31 Guiding the PE cable (Silver PSU)

- ◆ Carefully turn the printer on the PSU side.
- ◆ Take the single end of the PE (not the forked end) cable that is already installed on the printer. Guide the cable through the right cable clip.

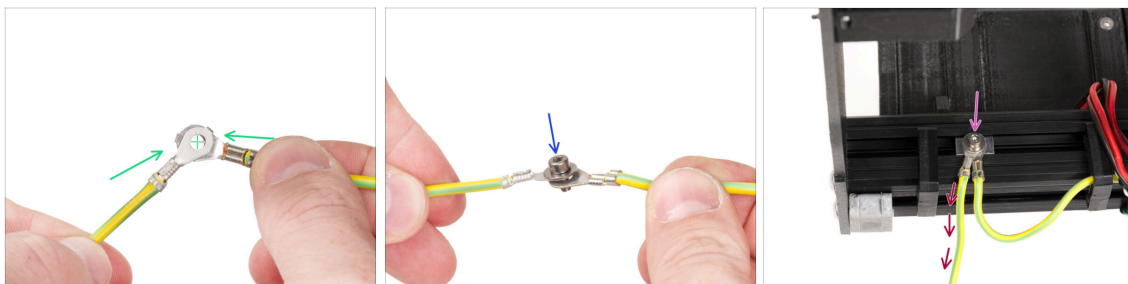
STEP 32 Connecting the PE cables (Silver PSU)

- ◆ Take the free end of the PE cable guiding from the printer and line up the connector with one of the connector of the extended PE cable.
- ◆ Push the M3x6 screw **and the M3w washer** through the both connectors.
- ◆ Attach the joint of cables to the M3nEs nut in the extrusion profile and secure it by fully tightening the M3x6 screw.
- ◆ The free extended PE cable must be in the left position and lead freely outside the printer.

STEP 33 Connecting the extended PE cable (Silver PSU)

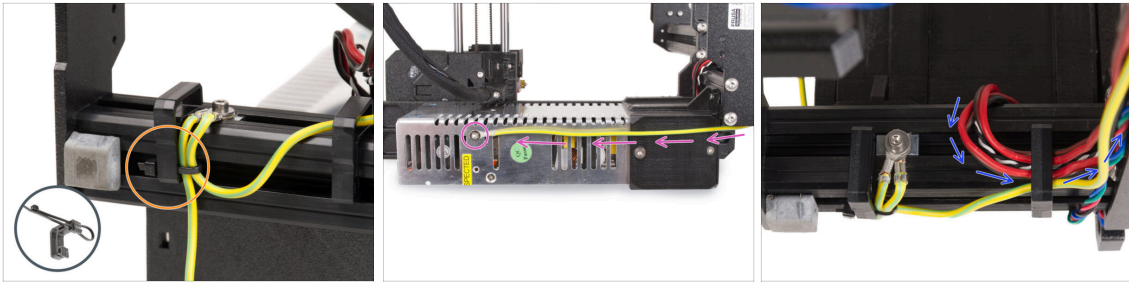

- Merge both PE cables and attach them with the zip tie to the left cable clip.
- Note two threaded screw holes in the silver power supply unit (PSU). Secure the extended ground connector to the "upper" hole using the M4x5 screw.
- Guide all PSU cables through the right cable clip.

STEP 34 Guiding the Z motor right cable (Silver PSU)

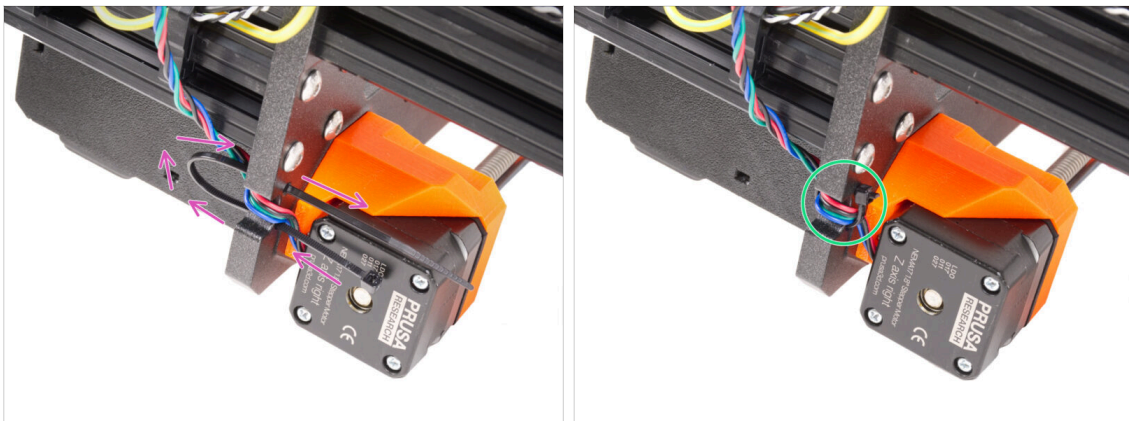

- Slide the zip tie through the circular holes in the frame to create a loop on both sides of the frame so that the cable goes through both the loops.
- Start tightening the zip tie so it is snug and holds the wires on both sides. Be careful not to over-tighten the zip tie as it could damage the wires. Cut off the remaining part of the zip tie very carefully.

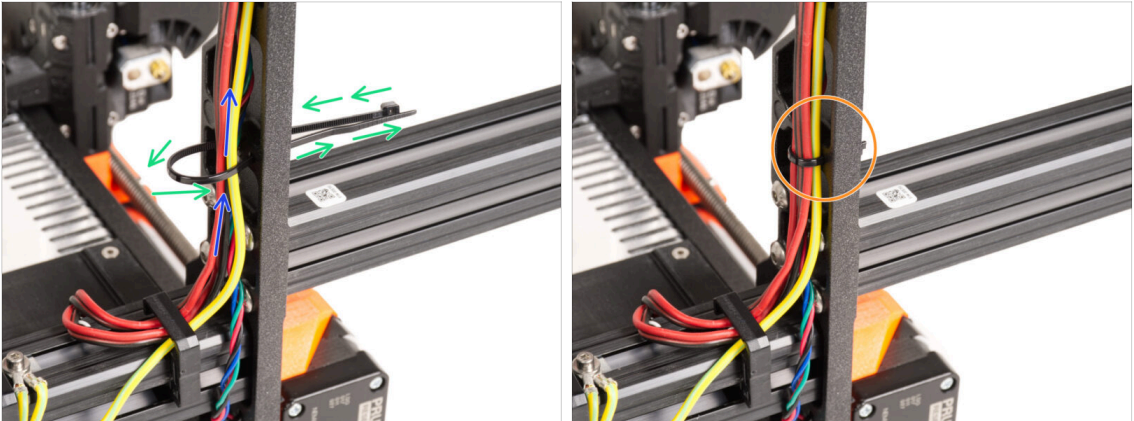
STEP 35 Guiding the power cable bundle (Silver PSU)

- Continue upwards and using another zip tie create the next loop.
- Guide the Z-axis cable and all cables from the PSU through the zip tie.
- Place the PE and power cables at the bottom of the bundle.
- Push the cable gently in the zip tie and tighten it so it is snug and holding the wires. Be careful not to over tighten the tie as it can cut the wires. Cut the remaining part.

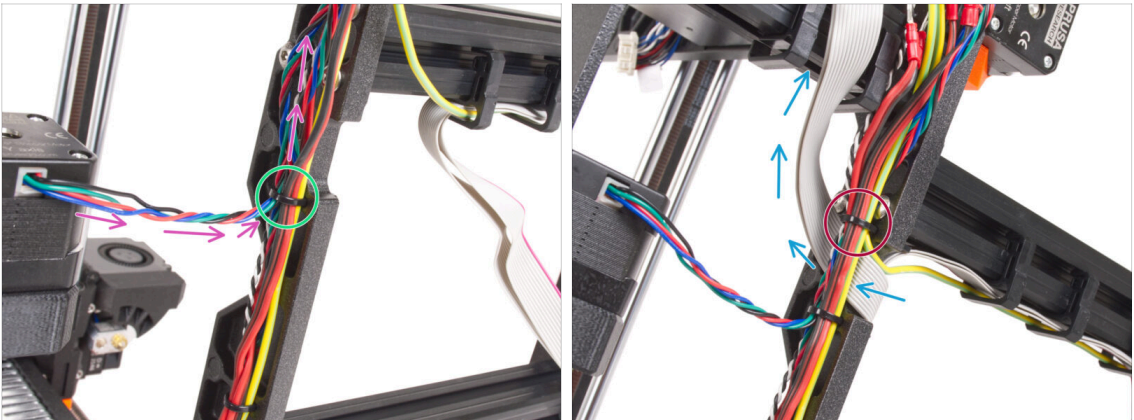
STEP 36 Guiding the power cables (Silver PSU)

- Continue guiding the cables toward the xBuddy. Include the Y motor cable into the bundle.
- Secure it with another zip tie to the frame.
- Carefully guide and fold the xLCD cable under the cable bundle. **Do not include the xLCD cable in the cable bundle.** Leave it free for now.
- Guide the PE cable from the xLCD through the cutout in the frame and include it in the cable bundle.
- Secure the cable bundle with the zip tie.

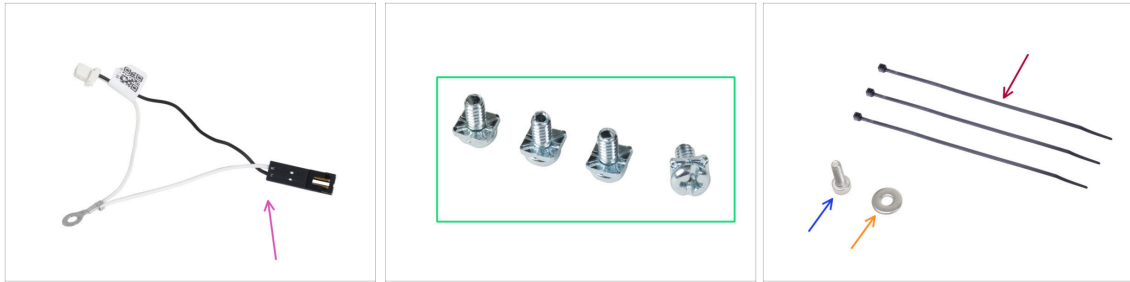
STEP 37 Power panic extended cable (Silver PSU): parts preparation

◆ For the following steps, please prepare:

- ◆ Power panic extended cable (1x)
- ◆ 3/32 PT screw (4x)
- ◆ Zip tie (3x)
- ◆ M3x6 screw (1x)
- ◆ M3w washer (1x)

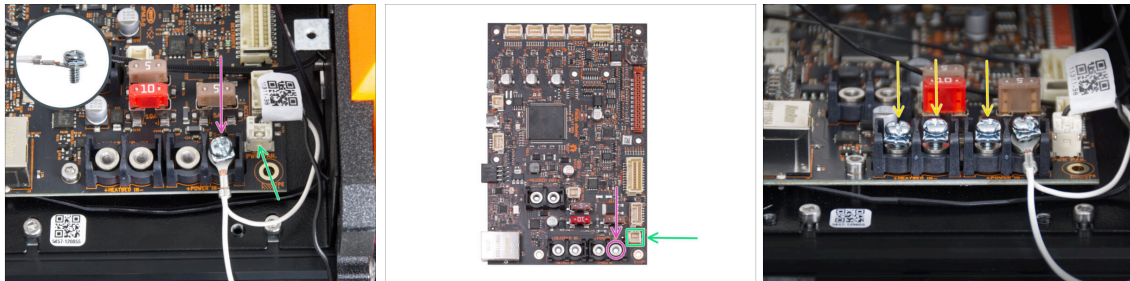
STEP 38 Extending the power panic cable (Silver PSU)

- ◆ Using the 3/32 PT screw, attach the power panic extended cable connector to the last (right) power terminal slot. **Do not completely tighten the terminal screw!** A few turns are enough for now, we will fully tighten the screw later.

ⓘ The cable must be free to move.

- ◆ Connect the white connector of the power panic extended cable to the slot labeled PWR PAN. on the xBuddy board.

- ◆ Leave the black connector of the power panic extended cable free for now.



Note that most of the following steps are taken with a black PSU and without power panic extended cable. However, specific instructions will be provided if there are differences for the silver PSU.

- ◆ Pre-screw three 3/32 PT screws into the terminals on the xBuddy board. **Do not tighten the screws completely**, 3-5 turns will be sufficient.

STEP 39 Connecting the PE cable (Silver PSU)

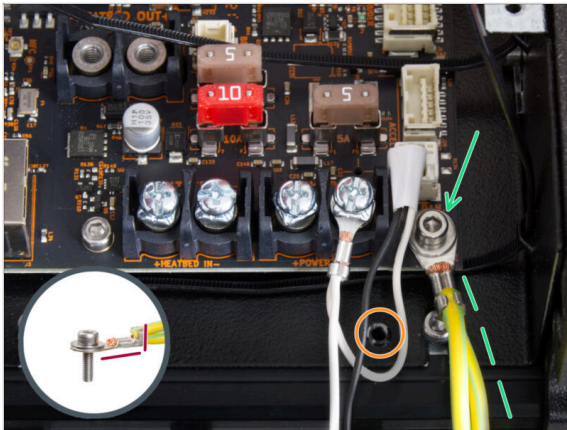

- ◆ Attach the PE cable connector to the right lower screw hole in the xBuddy box. Secure the cable with the M3w washer and the M3x6 screw. Tighten the screw firmly.
- ⚠ Note the correct orientation of the PE connector.
- ◆ Guide the PE cable so that it does not interfere with the threaded hole under the xBuddy board.

STEP 40 Connecting the PSU cables (Silver PSU)

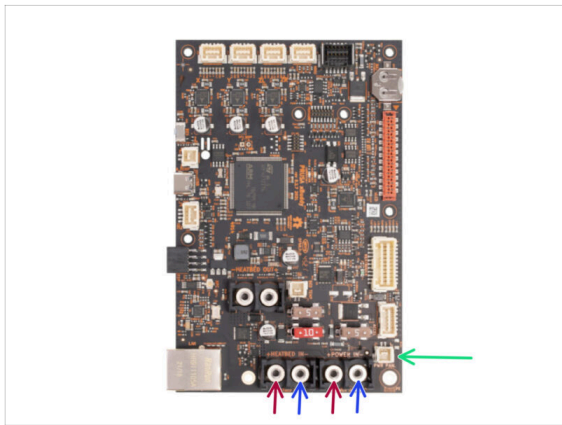
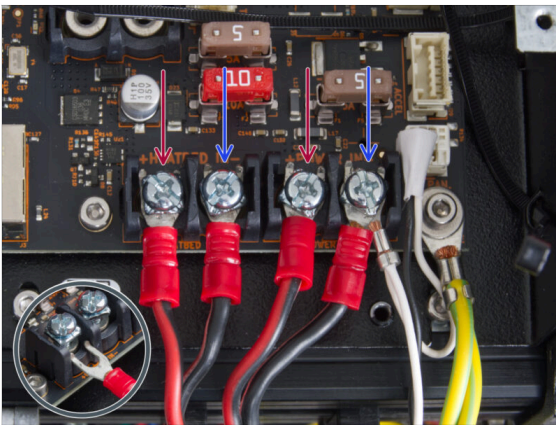

- ◆ Plug the power cables under the pre-screwed terminal screws on the xBuddy board in this order (starting from the left with the first pair of the PSU cables). :
 - ◆ Red power cable (positive)
 - ◆ Black power cable (negative)
 - ◆ Red power cable (positive)
 - ◆ Black power cable (negative) - connect together with the extended power panic cable. The extended power panic cable must be underneath.
- ◆ Secure all power cable connectors with the terminal screws. **Tighten the screws firmly.**
- ⚠ **Verify the correct placement of the cables comparing it to the picture. This is crucial! Incorrect wiring may cause damage to your printer!**

STEP 41 Connecting the power panic cable (Silver PSU)

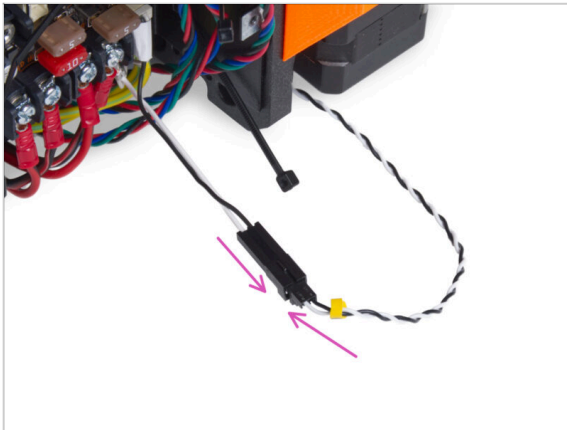

- ◆ Plug the power panic guiding from the PSU into the power panic extended cable.

STEP 42 Securing the PSU cables

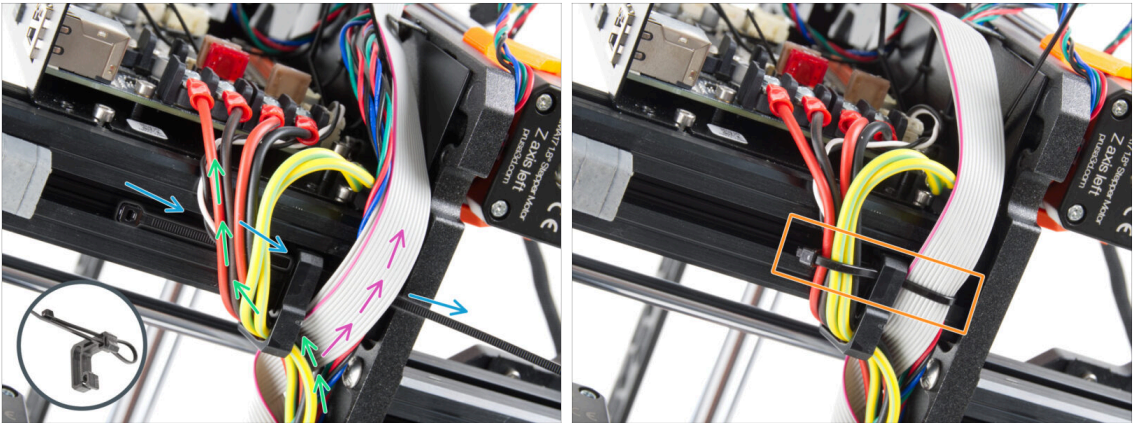

- Divide the cable bundle into two paths:
- ◆ Insert the zip tie through the bottom hole in the cable clip.
- ⓘ See the detail showing an example how to guide a zip tie through the cable clip.
- ◆ Guide the cables from the PE cables, PSU cables and Power Panic cable around the left side of the cable clip.
- ◆ Guide the xLCD cable and motor cables around the right side of the cable clip.
- ◆ **Very gently** tighten the cables with the zip tie. Cut off the remaining zip tie.

STEP 43 Guiding the Z motor left cable

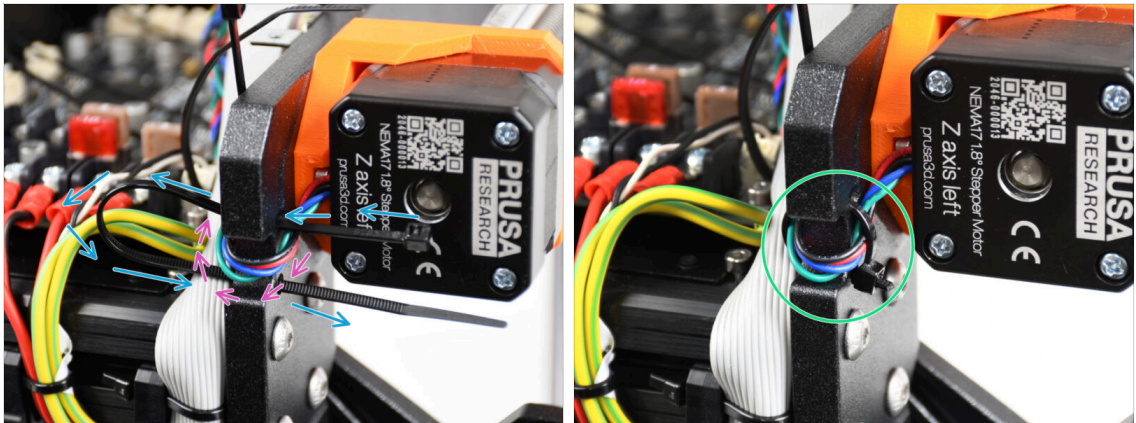

- ◆ Push the zip tie through the frame under the Z motor left.
 - ◆ Guide the Z motor left cable through the cutout in the frame to the xBuddy box.
 - ◆ Carefully tighten the zip tie. Cut off the excess of the zip tie.
- ⚠ **Do not overtighten the zip tie, it may fatally damage the cable.**

STEP 44 Motor cable adapters: parts preparation

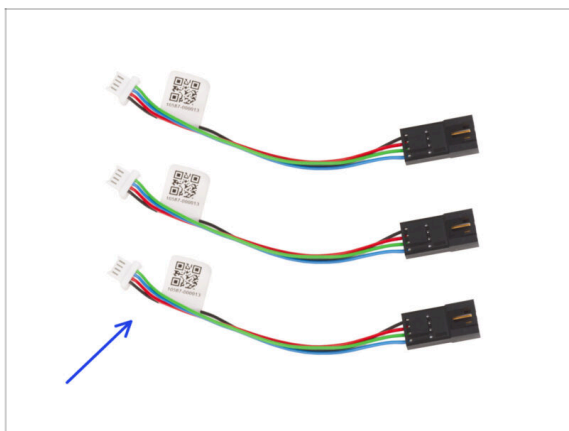

- ◆ For the following steps, please prepare:
- ◆ Motor cable adapter (3x)

STEP 45 Connecting the motor cable adapters

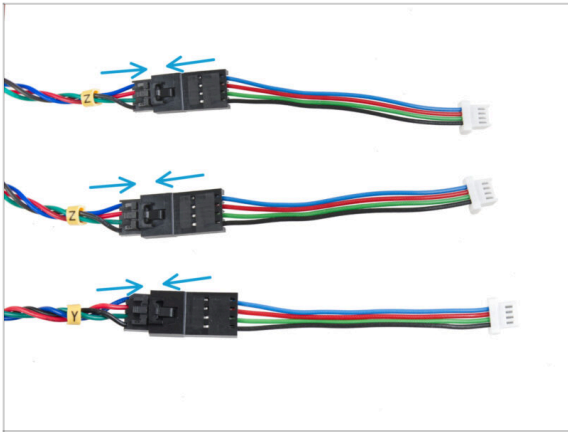

- ◆ Guide all motor cables (labeled Y, Z, Z) out of the printer.
- ◆ Plug each motor cable into the motor cable adapter. You will feel a slight click when the connector is properly plugged in.

STEP 46 Connecting the motor cables

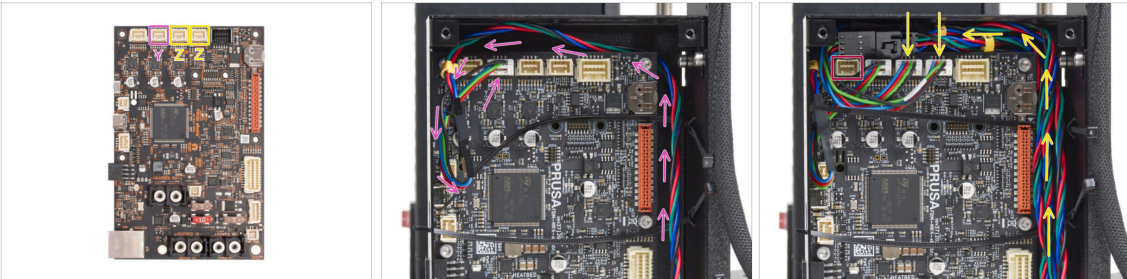

- ◆ Connect the Y motor to the second slot from the left. Guide the cable along the right side of the xBuddy box and behind the edge of the xBuddy board.
- ◆ Connect the Z motor cables to the third and fourth slots. The order of wiring does not matter.
- ⚠ Leave space around the first slot for plugging in another cable which will be connected later on.

STEP 47 Connecting the xLCD cables

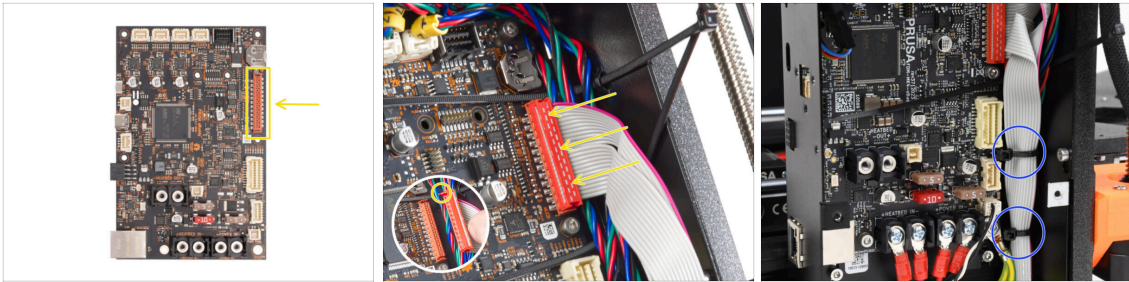

- ◆ Connect the xLCD to the slot on the right side of the xBuddy. Note the safety latch on the xLCD cable connector. The latch must fit into the upper side of the connector.
- ⚠ **Make sure that all the cable guiding over the zip ties in the xBuddy box, not under the zip ties.**
- ◆ Arrange the xLCD cable like in the picture. The xLCD must covering the cable bundle. Tighten the cable bundle with the first two zip ties in the bottom of the xBuddy box. **Do not overtighten the zip ties!**

STEP 48 Haribo

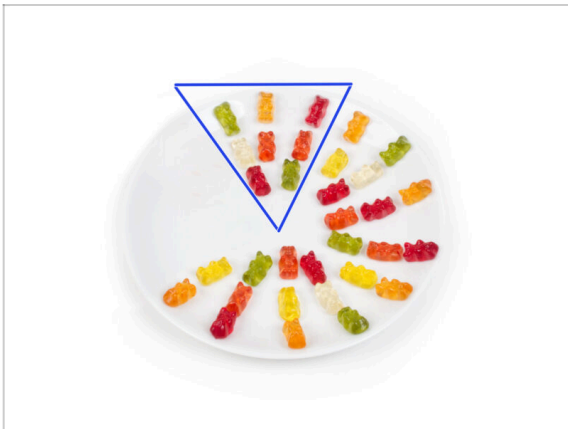

- ◆ Eat eight gummy bears.
- i **Did you know that** the original gummy bears were inspired by the dancing bears of Europe, and Riegel named them "Gummibärchen," which means "little rubber bears" in German.

STEP 49 That's it

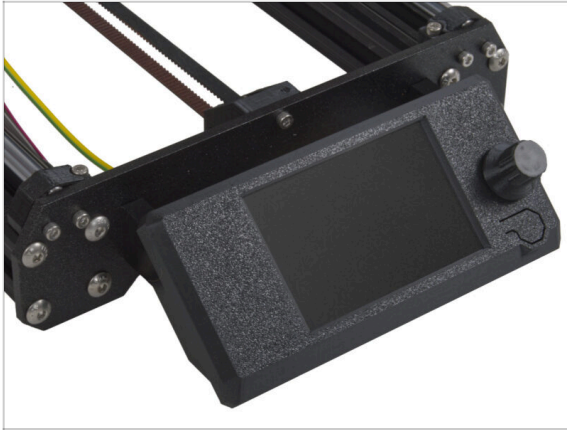

- ◆ The xLCD assembly and PSU cables are just in place.
- ◆ Let's continue to the next chapter **6. Heatbed upgrade**

6. Heatbed upgrade

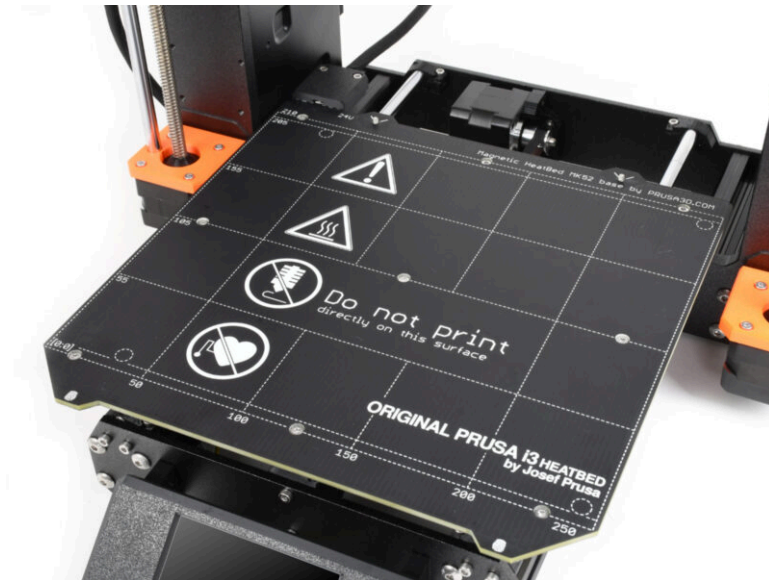

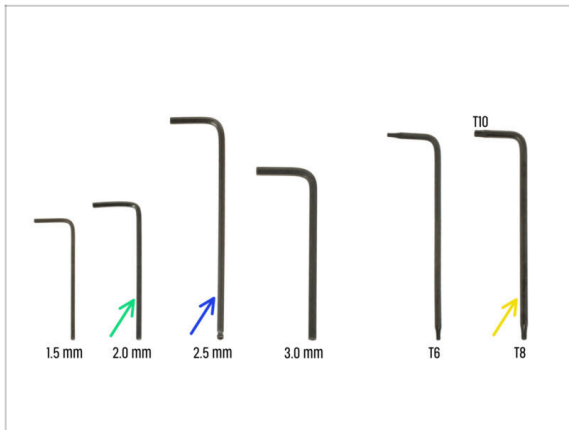
STEP 1 Tools necessary for this chapter

For this chapter, please prepare:

- 2.0mm Allen key
- 2.5mm Allen key
- T8/10 Torx key

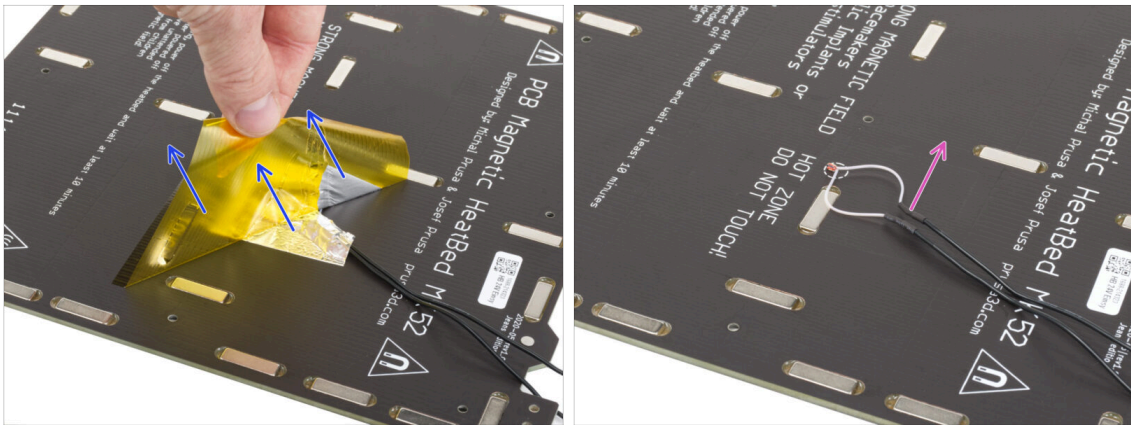
STEP 2 Removing the heatbed thermistor

In the upcoming steps, you will replace the old heatbed thermistor (from your previous printer model) with a new version that is compatible with MK4, MK3.9, and MK3.5.



If you purchased a new heatbed with the upgrade kit — commonly for users with printers featuring 2+1 screws on the old heatbed — ensure that the new thermistor is pre-installed. You can easily verify this by checking for a white connector at the end of the thermistor cable. The presence of this connector indicates that the new thermistor is already in place and you can skip to [Heatbed cable assembly: parts preparation](#)

- From the bottom side of the heatbed, peel off the yellow Kapton tape and silver aluminum tape.
- Remove the heatbed thermistor cable from the heatbed.

STEP 3 New heatbed thermistor: parts preparation

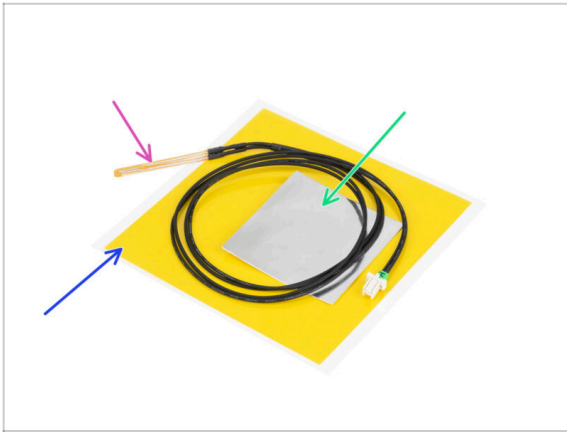

- For the following steps, please prepare:
- MK4 Heatbed thermistor (1x)
- Kapton tape (1x)
- Aluminum tape (1x)
- ⚠ **Pay attention to the instructions!**
The "yellow" Kapton tape tends to curl up and you won't be able to restore its initial shape!!
- ℹ All the necessary parts can be found in the **Heatbed thermistor set bag**.

STEP 4 Preparing the heatbed and thermistor

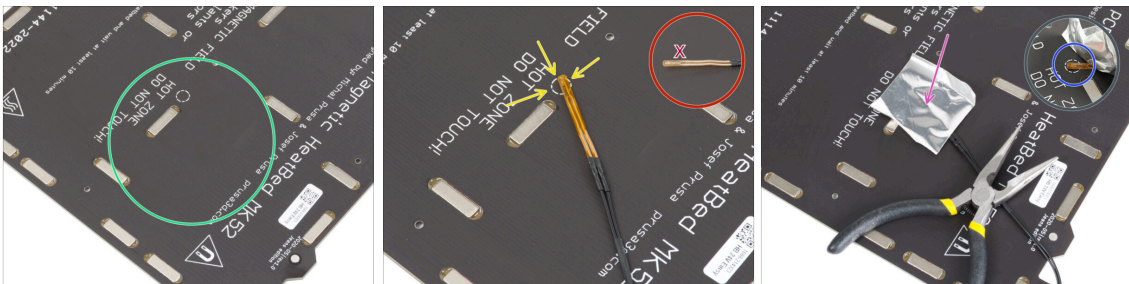

- After you have removed the thermistor and the tapes, clean the entire board to remove any grease. You can leave the glue, which was under the aluminum tape.
- Place the thermistor on the heatbed. **The tip of the thermistor must be in the circle.**
- ⚠ **If you miss this spot, the printer will read incorrect temperature values.**
- ⚠ **Note which side the sensor is attached to the heatbed.**
- Take the silver aluminium tape and carefully peel off the protective film.
- Stick the tape to the heatbed, **BUT ONLY** in the centre of the thermistor (inside the circle shape). We need to double-check the correct position.
- Peel or bend the tape slightly, to reveal the tip of the thermistor.

STEP 5 Covering the thermistor

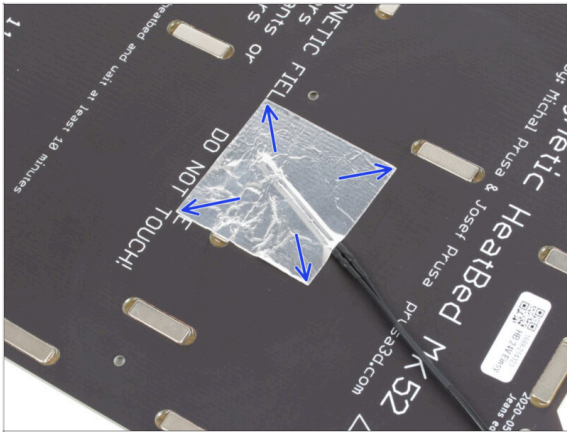

- ◆ Maintain the thermistor position and cover it with aluminum tape. Ensure that the whole thermistor sensor is covered with the tape.

STEP 6 Fixing the thermistor in place

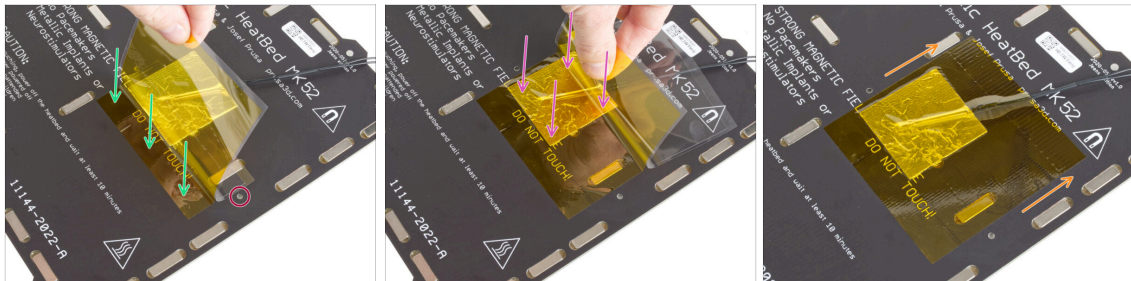

- ⚠ Now it is time to apply the final "yellow" Kapton tape. **DON'T PEEL OFF the entire tape, it will curl up!!!**
- Peel off about 1 cm (1/2 inch) strip of the Kapton tape and stick it to the heatbed. Make sure the tape adheres properly.
- ⚠ **Make sure the Kapton tape does not overlap any screw holes in the heatbed.**
- ⓘ The Kapton tape has a bigger area than the silver tape. Make sure the silver tape is overlapped from all sides.
- Keep applying the tape. Make sure it doesn't curl too much in the thermistor area.
- Check that the entire adhesive surface is properly attached to the heatbed.

STEP 7 Heatbed cable assembly: parts preparation

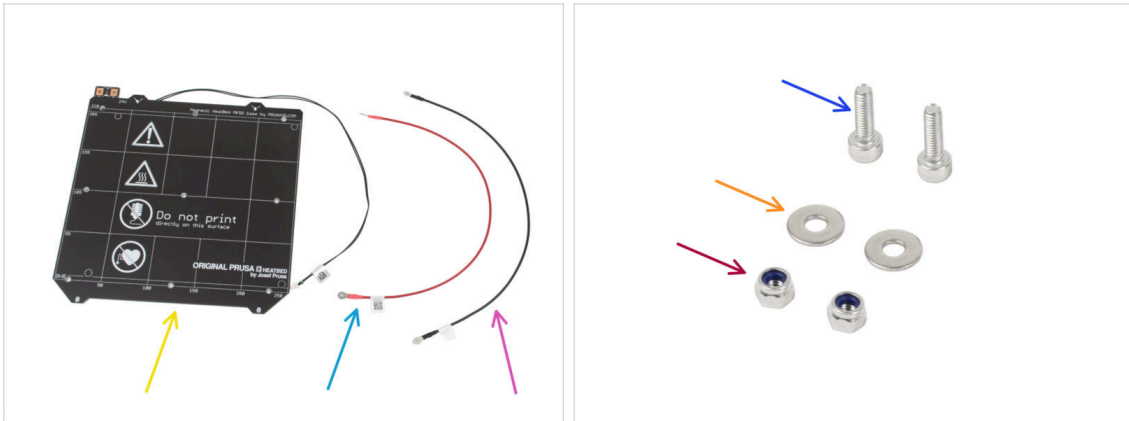

● For the following step please prepare:

- Heatbed MK52 24V (1x)
- Heatbed cable red (1x)
- Heatbed cable black (1x)
- M3x10 screw (2x)
- M3w washer (2x)
- M3nN nut (2x)

STEP 8 Heatbed cable assembly (part 1)

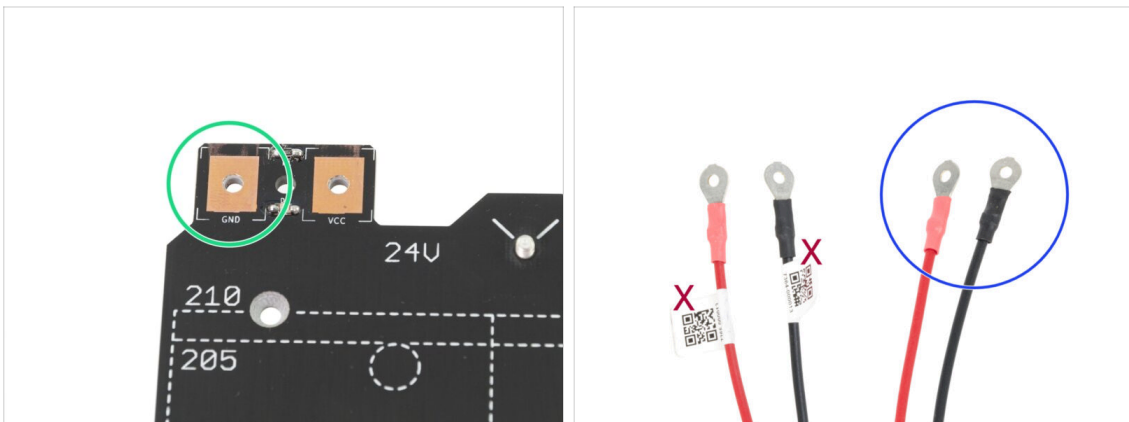

- **IT IS IMPORTANT** to connect the power cable correctly. Before you start the assembly have a look at the pins. The one on the left with "GND" sign must be connected to the **BLACK WIRE**.
- Take both Heatbed cables. Note the label on each cable. For the following steps, prepare the ends of the cables **without the label**.

STEP 9 Heatbed cable assembly (part 2)

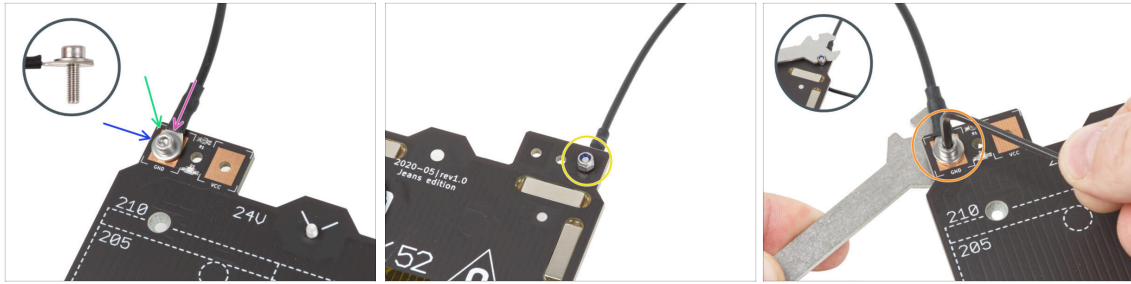

- ◆ Place the black wire above the pin with "GND" sign. **Use the end of the cable that is not labeled with QR code.** The QR code must be at the other end.
- ◆ Place the M3w washer above the round cable connector.
- ◆ Press the M3x10 screw through all parts.
- ◆ Hold the screw and carefully turn the heatbed upside down.
- ◆ Attach the M3nN nut onto the M3x10 screw and tighten it slightly.
- ◆ Turn the heatbed back around. Using the universal wrench and the Allen key, tighten up the screw. We will adjust the cable position later on, **therefore do not tighten the screw too firmly yet.**

STEP 10 Heatbed cable assembly (part 3)

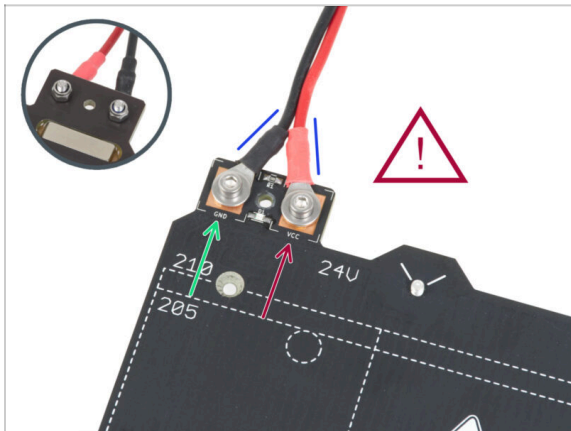

- ◆ Repeat this procedure for the second (Red / + / VCC) wire. **Use the end of the cable that is not labeled with QR code.** The QR code must be at the other end.
- ⚠ **Before proceeding further, please check again that:**
 - ◆ **BLACK** wire must be connected to the "GND"
 - ◆ **RED** wire must be connected to the "VCC"
- ◆ The cable cover, which will be applied later requires the connectors to be slightly inclined towards each other. Press them gently, but leave a gap between them.
- ⚠ **Now, tighten both screws firmly using the Allen key and the wrench. Maintain the position of the connectors while tightening.**

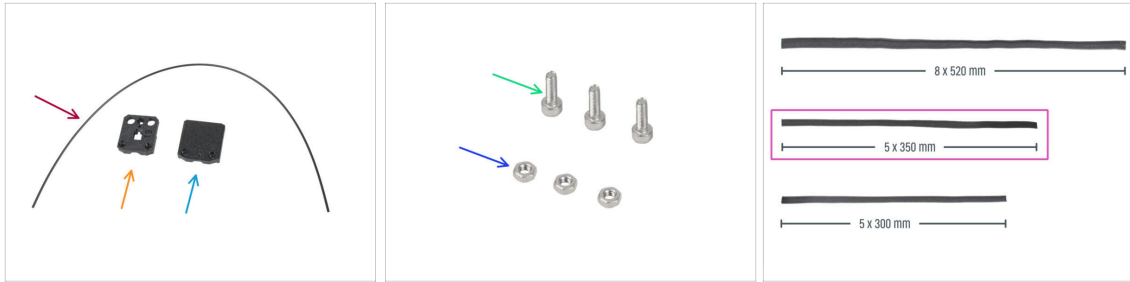
STEP 11 Covering the heatbed cables: parts preparation

◆ **For the following steps, please prepare:**

- ◆ Nylon 2x380 mm (1x)
- ◆ heatbed-cable-cover-bottom
- ◆ heatbed-cable-cover-top
- ◆ M3x10 screw (3x)
- ◆ M3n nut (3x)
- ◆ Textile sleeve 5x350 (1x)

i The ends of the textile sleeves are heat-sealed at the factory to prevent ripping. To open them, the sealed end joints must be cut or torn.

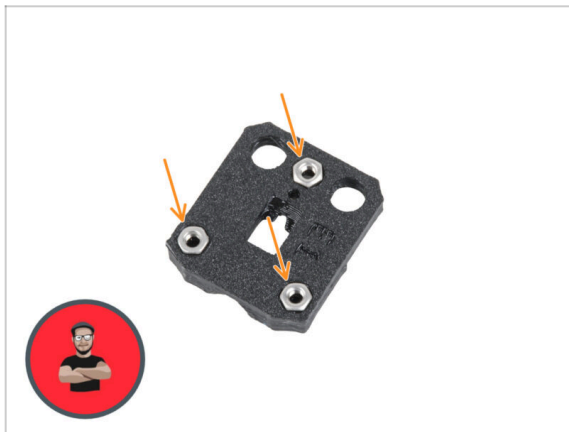
STEP 12 Assembling the heatbed-cable-cover-bottom

- ◆ Insert three M3n nuts into the shaped openings in the heatbed-cable-cover-bottom.

i Use the screw pulling technique.

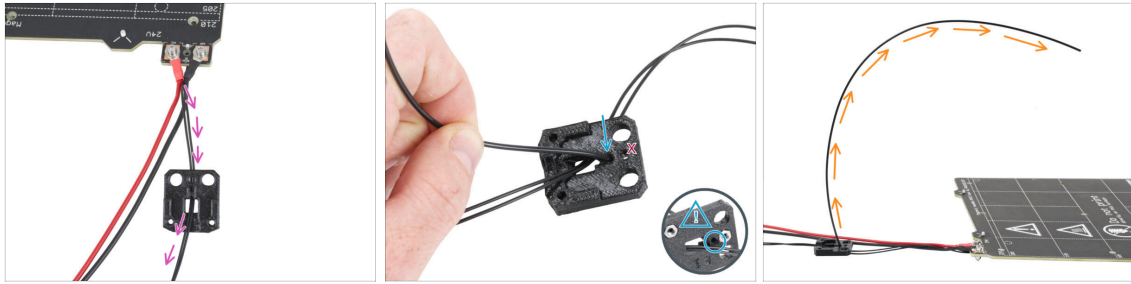
STEP 13 Assembling the heatbed-cable-cover: nylon filament

- ◆ Place the heatbed-cable-cover-bottom like in the picture. Push the heatbed thermistor cable through the heatbed-cable-cover-bottom.
- ◆ Insert the nylon filament into the hole in the heatbed-cable-cover-bottom. Don't let the nylon filament stick out too much on the other side. It should not protrude more than 2 millimeters.
- ⚠ **When inserting the nylon filament, ensure that the filament does not damage the thermistor cables under the printed part.**
- ◆ Orient the curve of the filament as shown in the third picture.

STEP 14 Assembling the heatbed-cable-cover-bottom

- ◆ Slide the cable-cover-bottom under the heatbed cable connectors (M3nN nuts). See the correct orientation in the picture.
- ◆ Secure the cover with the M3x10 screw from the top. Tighten the screw firmly.
- ⚠ **Make sure the nylon filament is still bent upward as in the previous step.**

STEP 15 Assembling the heatbed-cable-cover-top

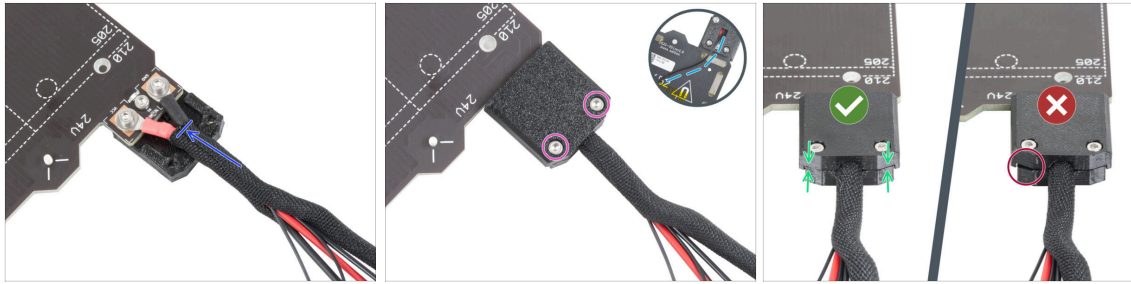

- Wrap the end of the cable bundle together with the nylon filament in the textile sleeve. Slide the sleeve as far towards the heatbed as possible.
- Attach the heatbed-cable-cover-top onto the junction and secure it with two M3x10 screws.
- On the bottom side, leave a slack on the thermistor cable for one finger to be pushed through.
- Make sure there is not a large gap between the covers.

STEP 16 Wrapping the textile sleeve

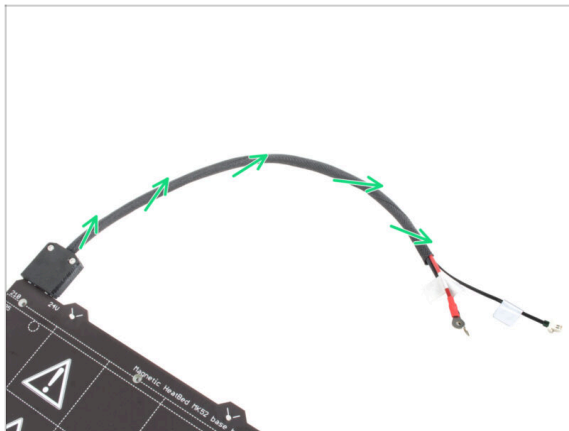

- Finish wrapping the cable bundle in the textile sleeve. Twist the sleeve around the cables **but do not twist cables inside.**

STEP 17 Installing the Expansion joints: parts preparation



◆ For the following steps, please prepare:

◆ Expansion joint (8x)

◆ M3x6r screw (8x)

STEP 18 Preparing the expansion joints

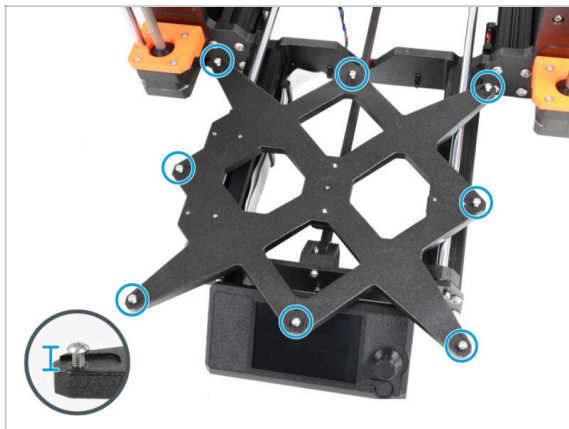

◆ Install eight M3x6r screws in the outer holes on the Y-carriage. **Do not tighten them completely.** A few turns are enough for now.

STEP 19 Installing the Expansion joints

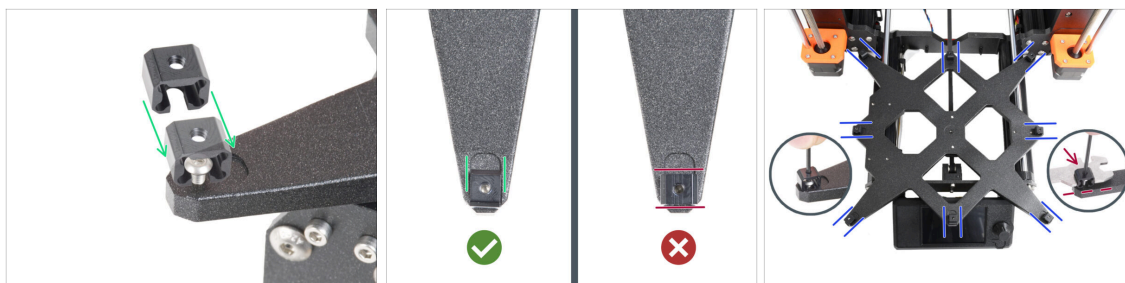

- i** Please note that **there are two versions of the Y-carriage**. This step describes the instructions for both versions, please be very careful.
- !** **The installation of the expansion joints needs to be done carefully.** It is crucial for the correct functionality of the printer. Carefully read the instructions:
 - Slide the expansion joint from the side on the M3x6r screw.
 - !** **Make sure the expansion joints are correctly oriented.** There is a recess with approximately the same shape as the expansion joint. The joint must fit into the recess. **See the second picture.**
- i** Some of the Y-carriages don't have recesses, depending on the version of the printer model. **Position the expansion joints according to the picture.**
 - Maintain the position and tighten the M3x6r screw using the 2.0mm Allen key.
 - Proceed the same for the rest of the expansion joints.
- !** **OLD Y-CARRIAGE:** On the **old Y-carriage without the recesses**, maintain the correct position and orientation of the expansion joint using the universal wrench while tightening.

STEP 20 Attaching the heatbed: parts preparation

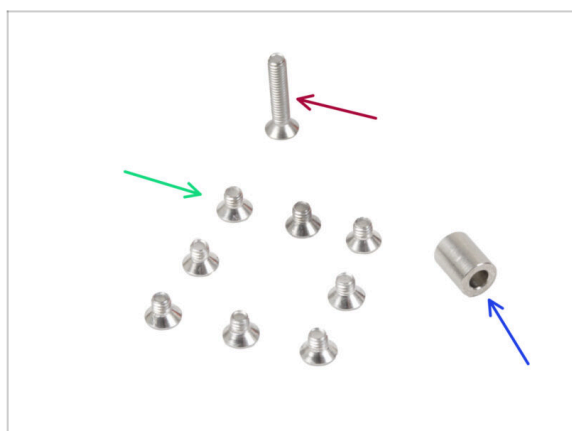

- For the following steps, please prepare:
 - M3x4bT screw (8x)
 - M3x14bT screw (1x)
 - Spacer 3.1x6x8 mm (1x)

STEP 21 Attaching the heatbed

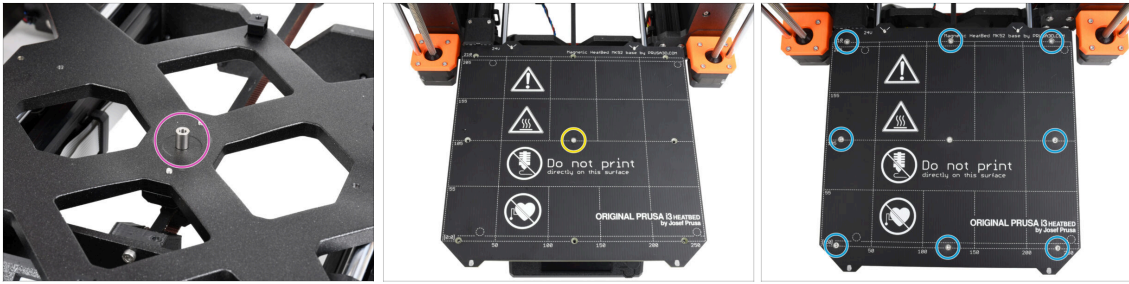

- ◆ Place the spacer onto the Y-carriage and align it with the hole in the center.
- ◆ Put the heatbed on the Y-carriage and secure it by the M3x14bT going through the spacer. **Do not fully tighten the screw yet.**
- ◆ Insert the M3x4bT screws into the remaining holes in the heatbed. **Do not fully tighten the screws yet.**

STEP 22 Tightening the heatbed

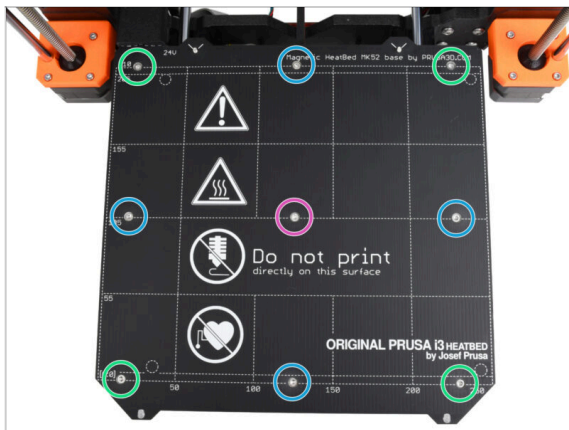

- ◆ After all screws are in place, tighten them using a T10 Torx key in the following sequence:
 - ◆ Center screw
 - ◆ First four screws (edges)
 - ◆ Last four screws (corners)
- ⚠ **Tighten the screws firmly and carefully.**

STEP 23 Heatbed-cable-holder: parts preparation

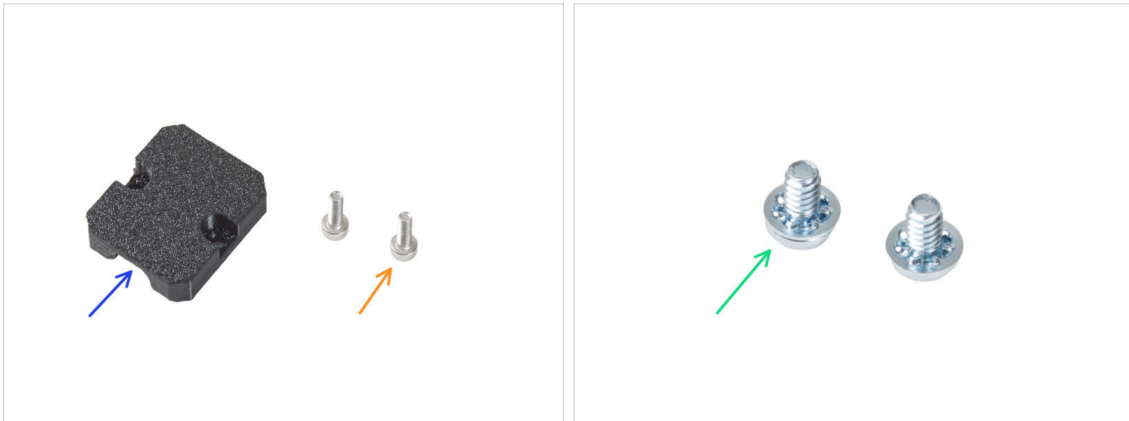

For the following steps, please prepare:

- Heatbed-cable-holder (1x)
- M3x6 screw (2x)
- Power terminal screw 6/32" (2x)

STEP 24 Guiding the heatbed cables

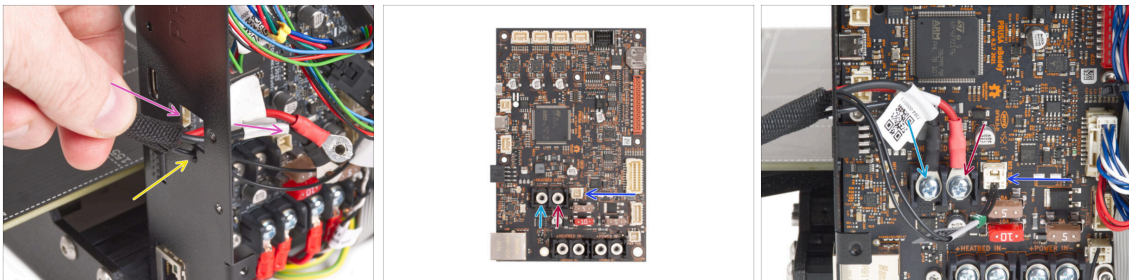

- Guide the heatbed cables through the square opening on the back of the xBuddy Box.
- Push the filament through the marked hole below the square opening.
- Place the **black** heatbed cable onto the **left** terminal and secure it with the terminal screw.
- Place the **red** heatbed cable onto the **right** terminal and secure it with the terminal screw.
- Connect the heatbed thermistor cable to the xBuddy board.

STEP 25 Covering the heatbed cables

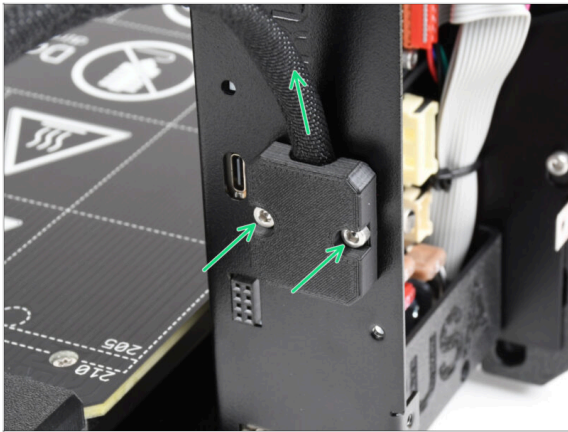

- Attach the heatbed-cable-holder to the xBuddy box. The cable bundle must be pointing up. Secure it by tightening both M3x6 screws firmly.

STEP 26 Installing the ESP module: parts preparation



- For the following steps, please prepare:
- ESP-01S Wi-Fi module (1x) *packed in black plastic packaging*
- M3x6 screw (1x)
- Wifi-cover (1x)

STEP 27 Installing the ESP module

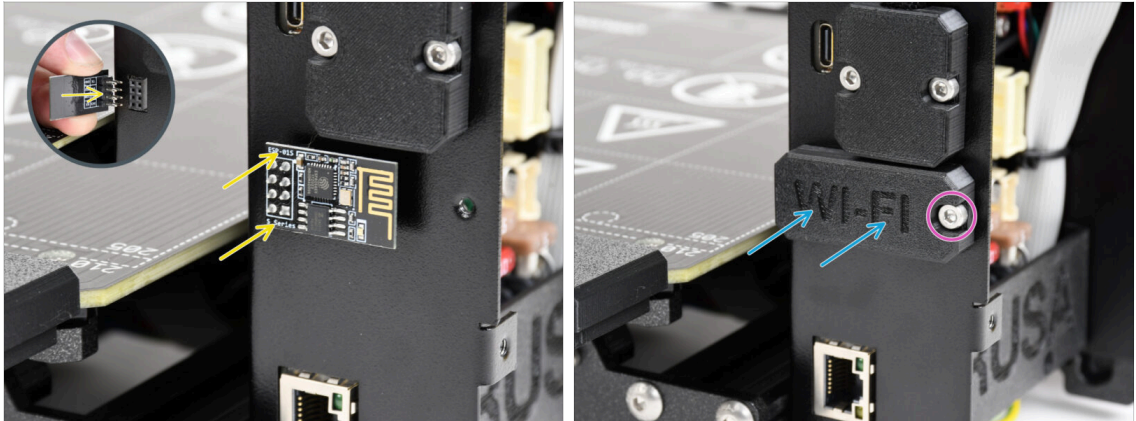

⚠ Be very careful when handling and connecting the ESP module to avoid bending and damaging the pins.

- **Grasp the ESP Wi-Fi module by the edges of the board** and plug its pins in the eight-hole slot in the xBuddyBox. Make sure the part is correctly oriented.
- Cover the ESP module with the wifi-cover.
- Secure it with the M3x6 screw.

STEP 28 Reward yourself!

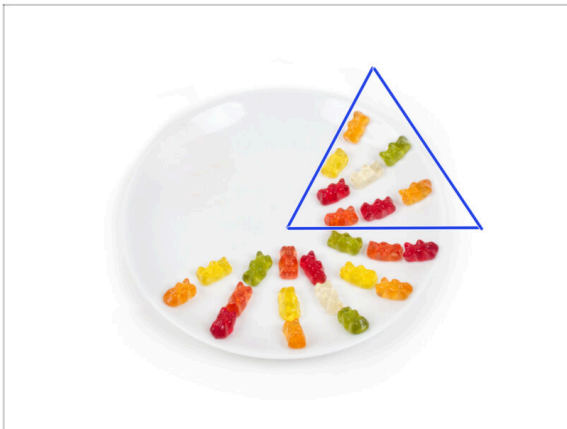

- Eat eight gummy bears.
- ⓘ **Did you know that** in 2014, a gummy bear-inspired emoji was added to the Unicode Standard, allowing gummy bear enthusiasts to express their love for the candy in digital conversations.

STEP 29 Almost there

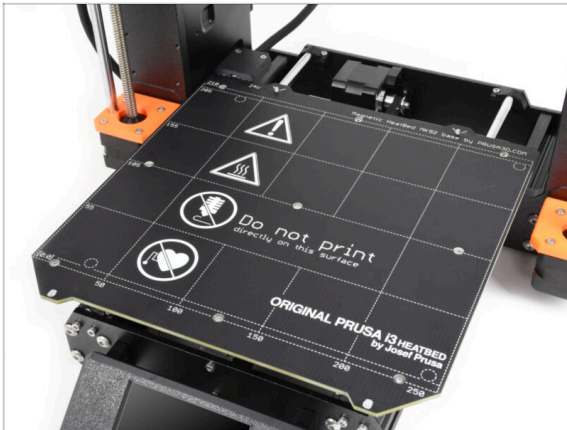

- ◆ So far nothing complicated, right? Expect nothing complicated :). Let's get into the last few chapters.
- ◆ Go to chapter 7. **Extruder upgrade**

7. Extruder upgrade



STEP 1 Tools necessary for this chapter

● For this chapter, please prepare:

● 2.5mm Allen key

● Needle nose pliers

● Safety glasses (*not included in the kit*)

ⓘ Safety glasses will need to be worn when shortening the nylon filament. It is not necessary to put the glasses on immediately. You will be prompted in time.

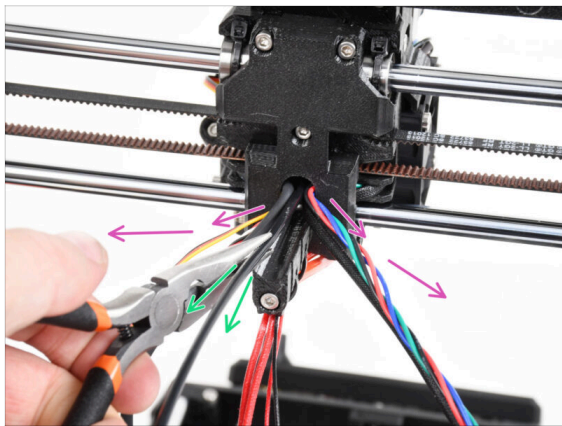
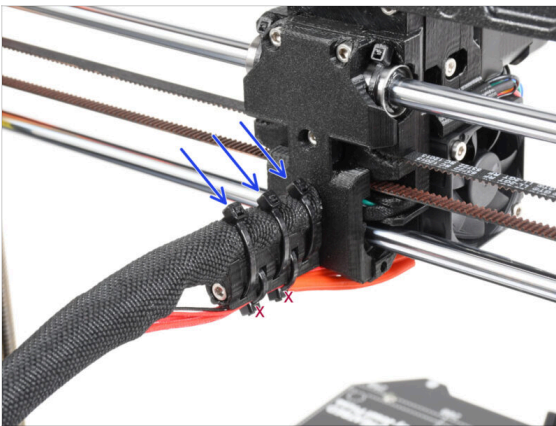
STEP 2 Removing the nylon filament

⚠ **Use safety glasses!**

● Take a look from the back of the printer and focus on the extruder.

● Cut off the three zip ties on the top of the textile sleeve.

⚠ **Do not cut the couple on the underside.**

● Spread all the cables from the extruder to the sides.

● Using the needle nose pliers pull out the black nylon filament from the extruder body.

⚠ **Be extra CAREFUL. The nylon filament can be very difficult to remove.**

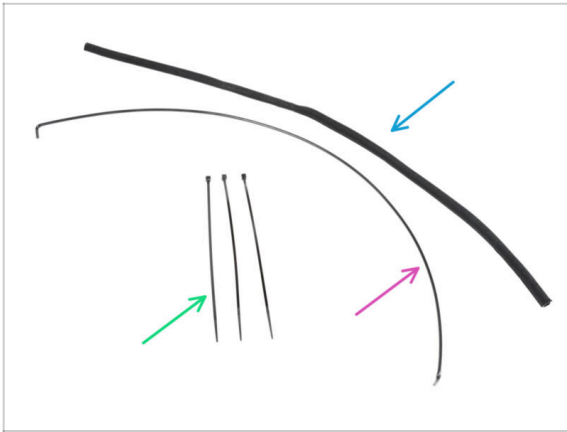
STEP 3 New nylon filament: parts preparation

◆ For the following steps, please prepare:

- ◆ Textile sleeve 8x520 (1x)
- ◆ Nylon 3x555 mm (1x)
- ◆ Zip tie (3x)

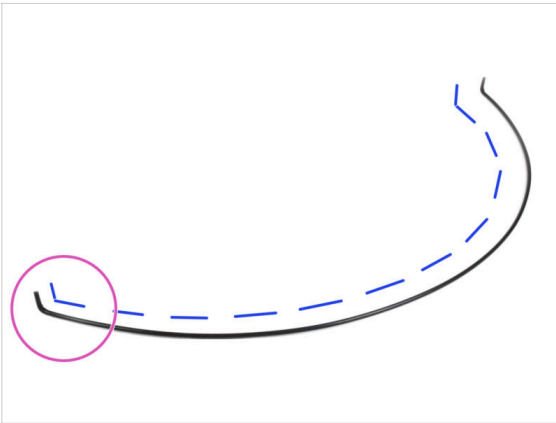
STEP 4 Cutting the nylon filament

◆ Place the nylon filament on a flat surface like in the picture. The bent ends must point upwards.

◆ Focus on the left end of the nylon filament.

⚠ **CAUTION: Use safety glasses!** There is a risk of the cut sharp parts of the filament flying off. These can cause serious injury to the eye.

◆ Using needle-nose pliers, make a cut about 1 cm from the bent end. Cut at an angle to create a sharp tip.

STEP 5 Inserting the nylon

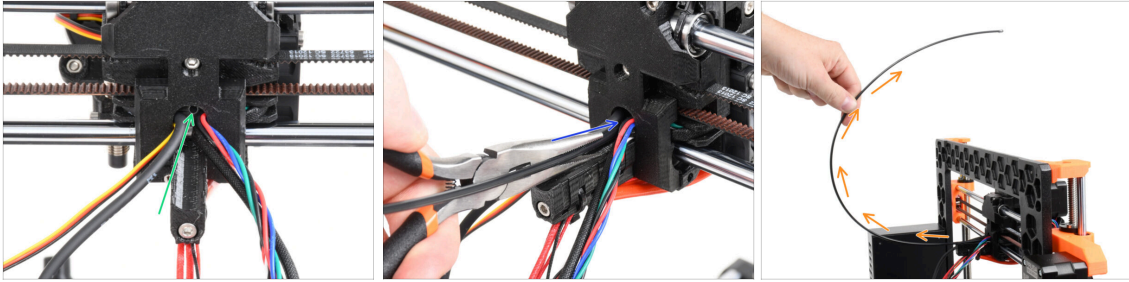

- ◆ **Locate the hole** for the NYLON filament in the cable opening. Using the smallest Allen key, ensure there are no obstacles inside.
- ◆ Using the pliers **insert the NYLON filament with the pointed end into the slot**. Twist the filament while pushing it in. Hold the extruder with your other hand.
- ◆ Once the nylon filament is successfully inserted, position that it inclines upwards as seen in the picture.

STEP 6 Wrapping the cable bundle

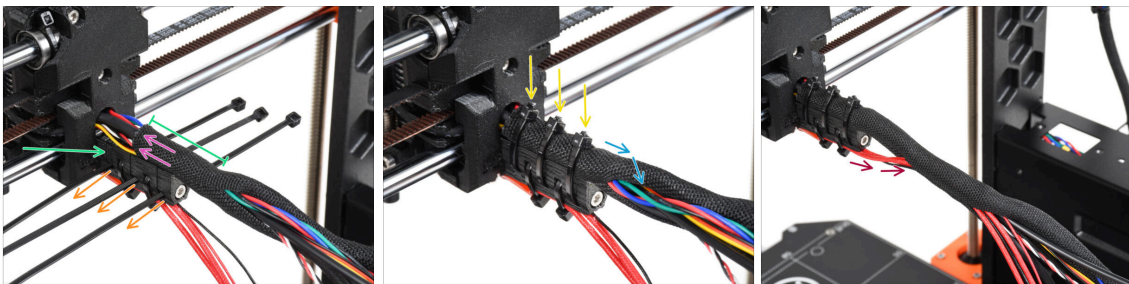

- ◆ Open one end of the textile sleeve and slide it on the cable bundle leading from the extruder. **Don't forget to include the black nylon filament inserted earlier!**
- ◆ The length of the first wrap should be slightly longer than the cable-holder part, about 5 cm is enough.
- ◆ Take 3 zip ties and insert them into the lower row of holes on the cable-holder.
- ◆ Slightly twist the textile sleeve around the cable bundle.
- ◆ Secure the cable bundle by tightening the three zip ties.
- ⚠ **IMPORTANT:** Cut the remaining part of each zip tie using pliers as close to its head as possible. Note the correct position of each zip ties's head (slightly off-centre to the left).
- ◆ Include the hotend cables to the cable bundle and wrap it into the textile sleeve.

STEP 7 Guiding the cable bundle

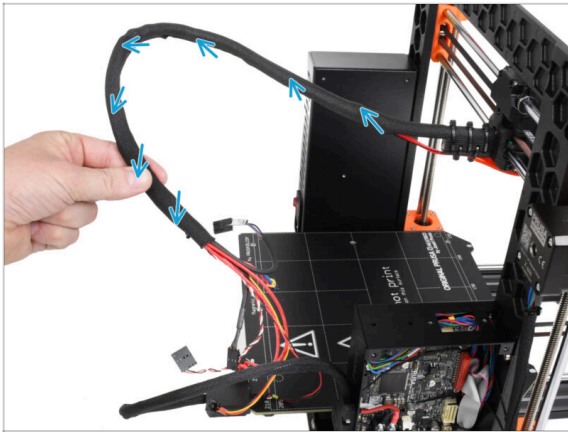

- ◆ Twist the entire length of the textile sleeve. Twist the sleeve, not the cables!

STEP 8 Ext-cable-holder: parts preparation

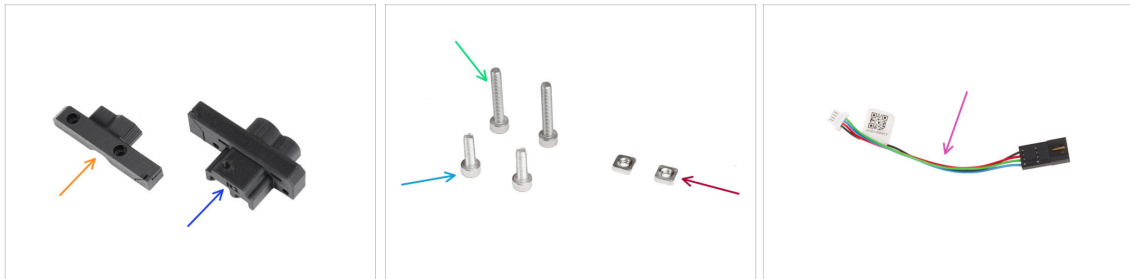

◆ For the following steps, please prepare:

- ◆ MK35-Ext-cable-holder-b (1x)
- ◆ MK35-Ext-cable-holder-a (1x)
- ◆ M3x18 screw (2x)
- ◆ M3x10 screw (2x)
- ◆ M3nS nut (2x)
- ◆ Motor cable adapter (1x)

STEP 9 Attaching the Ext-cable-holder



- ◆ Insert two M3x8 nuts all the way into the Ext-cable-holder-a.
- ◆ Take the bent end of the nylon filament. And locate the hole in the Ext-cable-holder-a.
- ◆ Push the bent part of the nylon filament into the hole and the bundle into the Ext-cable-holder-a.

STEP 10 Assembling the Ext-cable-holder



- ◆ Take the X motor cable and guide it **over the extruder main cable** through the left channel in the Ext-cable-holder-a.
 - ⚠ **Guiding the X motor cable behind the main cable could cause problems with axis travel when printing.**
- ◆ Cover the cables with the Ext-cable-holder-b.
- ◆ Join both parts together by tightening two M3x18 screws.

STEP 11 Attaching the extruder cable bundle

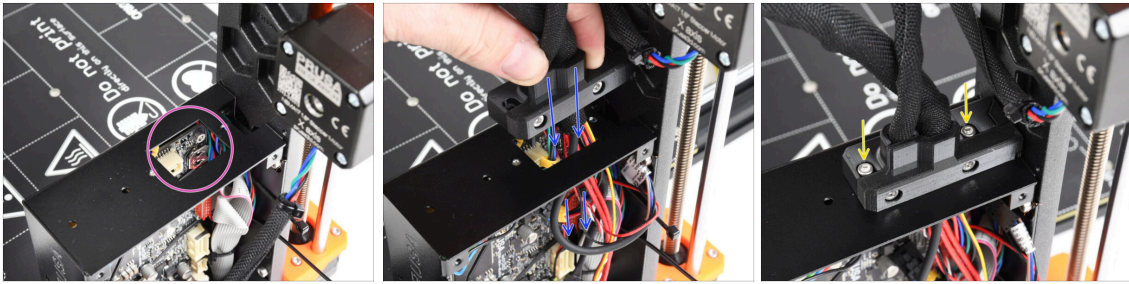

- ◆ Check that no cable is obstructing the rectangular hole in the xBuddy case.
- ◆ Push the Ext-cable-holder with the cables through the hole in the xBuddy box to the electronics.
- ⚠ Double-check that the **X motor cable does not guide behind the extruder main cable**. Compare it with the picture.
- ◆ Attach the Ext-cable-holder onto the xBuddy box with the two M3x10 screws.
- ◆ Leave the cables free in the xBuddy box for now. We will connect them later on.

STEP 12 Connecting the X motor cable

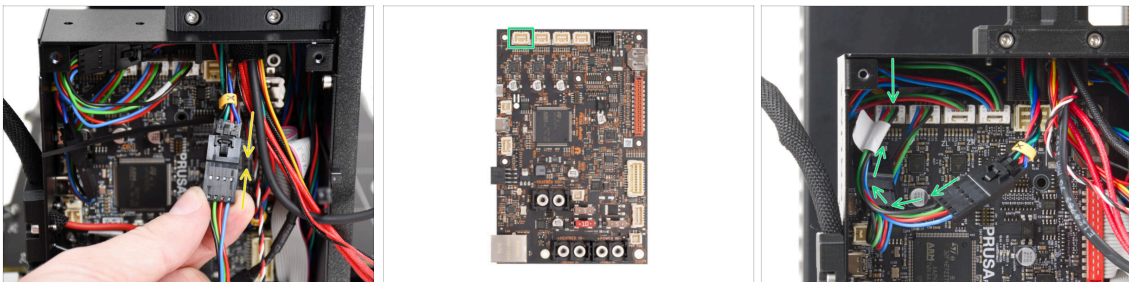

- ◆ Plug the X motor cable into the motor cable adapter. You will feel a slight click when the connector is properly plugged in.
- ◆ Connect the X motor cable to the first slot from the left on the xBuddy board.

STEP 13 MK3.5 adapter cable: parts preparation

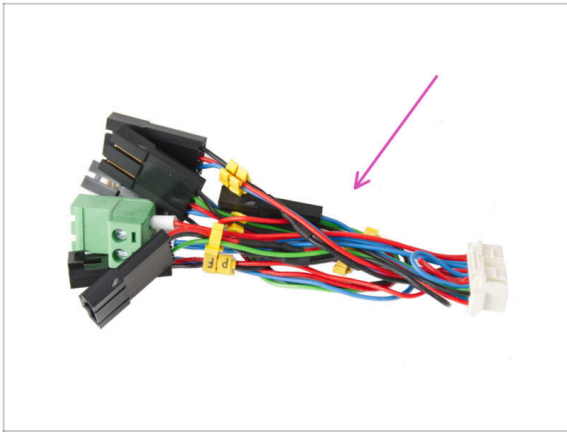

- ◆ For the following steps, please prepare:
- ◆ MK3.5 adapter cable (1x)
- ⓘ Notice the yellow markings on each cable. We will follow these markings in the following steps.

STEP 14 MK3.5 adapter cable connecting (part 1)

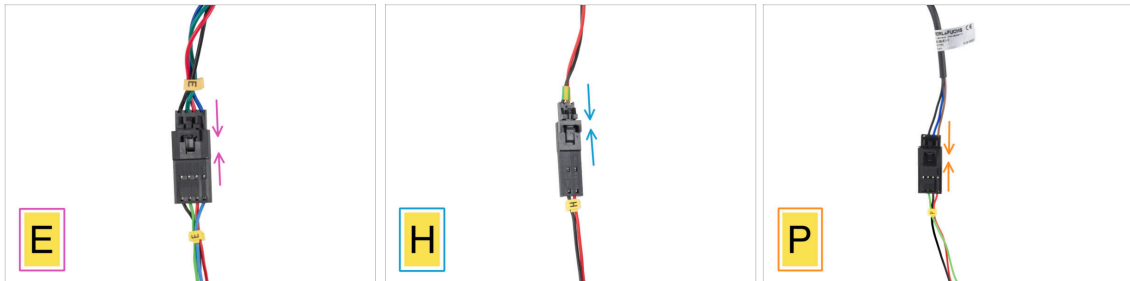

- ◆ Now we will plug each extruder cable into the MK3.5 adapter cable. **Follow the markings on the adapter cable and the markings and colors of the cables guiding from the extruder.**
- ⓘ In the following pictures showing the connection of the cables, the MK3.5 adapter cable is always the one at the bottom (always with the yellow cable marking).
- ◆ Plug the Extruder motor cable into the adapter cable labeled "E".
- ◆ Plug the Hotend thermistor cable (red & black wire) into the adapter cable labeled "H".
- ◆ Plug the SuperPINDA/P.I.N.D.A. sensor cable into the adapter cable labeled "P".
- ⓘ P.I.N.D.A. sensor cable has four wires instead of three (SuperPINDA) in the connector and can have a black or grey colored protective sheath.

STEP 15 MK3.5 adapter cable connecting (part 2)

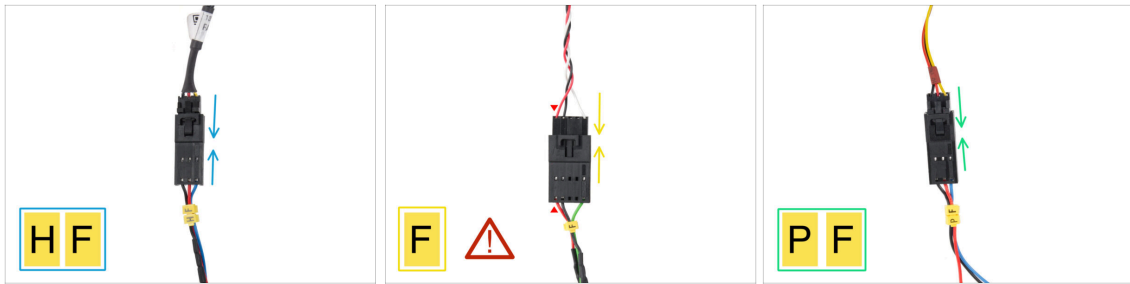

- Plug the Hotend Fan cable into the adapter cable labeled "HF".
 - ⓘ The **design of the hotend fan cable may vary** depending on which variant you have. Either a cable bundle wrapped with a textile sleeve or bare cables without a wrap.
- Plug the Filament sensor cable into the adapter cable labeled "F". The **red wire on the Filament sensor cable and the xBuddy adapter cable must be on the same side!**
 - ⚠ **WARNING: Correct wiring is critical! Failure to do so may irreversibly damage the electronics.**
- Plug the Print Fan cable into the adapter cable labeled "PF".

STEP 16 MK3.5 adapter cable connecting (part 3)

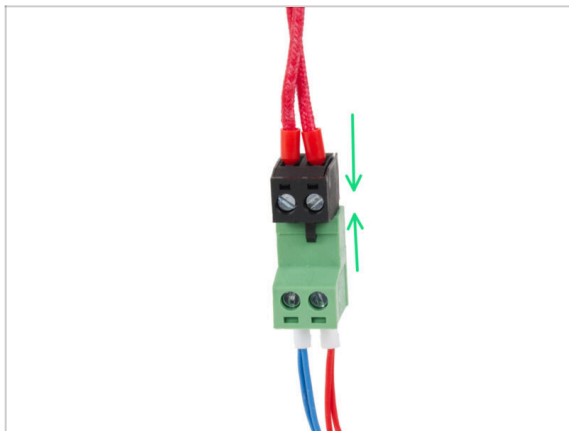

- Connect the hotend heater cable to the green connector on the xBuddy cable adapter.

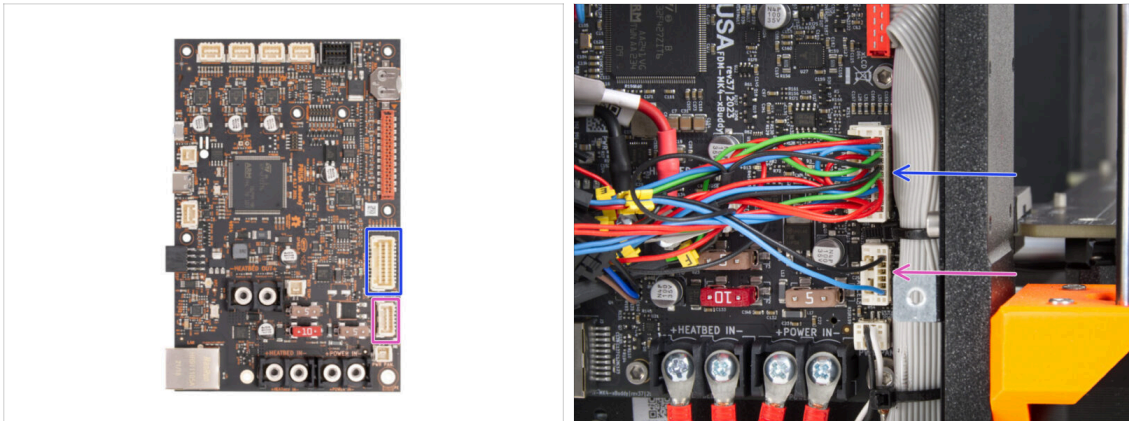
STEP 17 MK3.5 adapter cable connecting (part 4)

There are two remaining connectors on the xBuddy cable adapter. **Connect them in the following order:**

- **Larger connector**
- **Smaller connector**

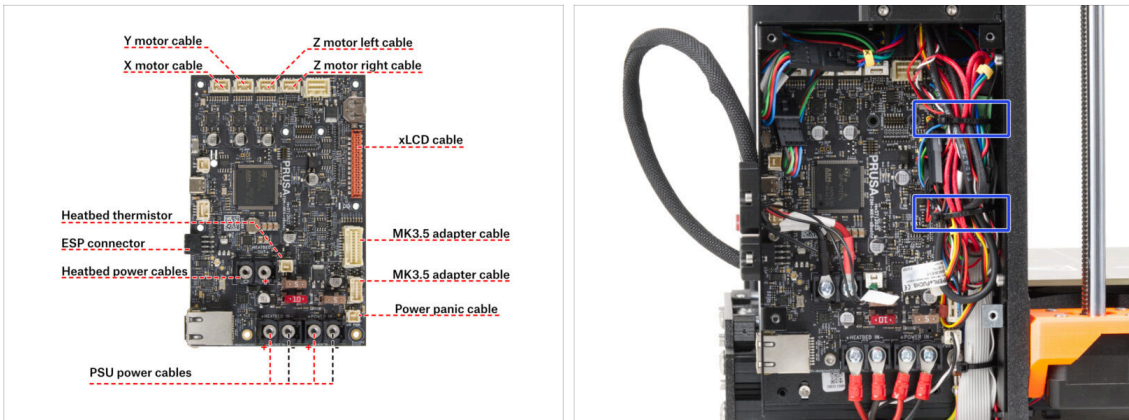
STEP 18 Verify all connections once more!

Check your electronics connection with the first picture.

⚠ Before covering the electronics, check and compare your wiring.

Compare your cable management with the second picture. Guide the cables along the inside of the box and maintain clearance above the electronics board for better cooling.

Tighten the cable bundle with two zip ties that are already prepared in the xBuddy box.

⚠ Make sure that all connectors are fully inserted and PSU cables properly tightened. Otherwise, there is a risk of damage to the printer!

STEP 19 xBuddy cover: parts preparation



◆ For the following steps, please prepare:

- ◆ xBuddybox-cover (1x)
- ◆ M3x6 screw (4x)
- ◆ EI-box-cover (1x)
- ◆ M3x10 screw (2x)

STEP 20 Covering the xBuddy box

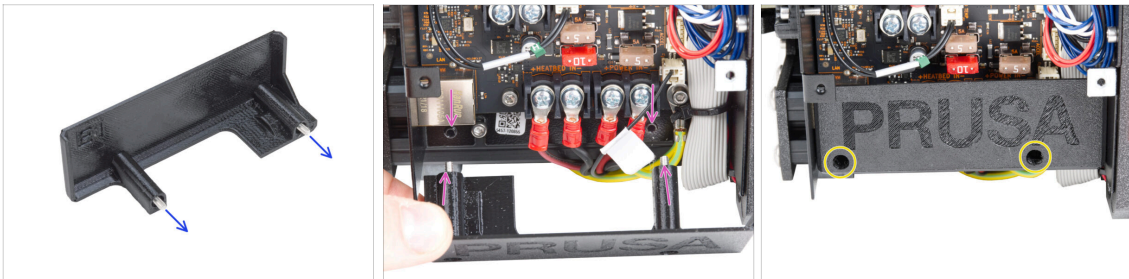

- ◆ Push two M3x10 screws through the ei-box-cover.
- ◆ Attach the cover to the xBuddy Box. There are two threaded holes in the xBuddy box. Make sure there is no cable in the way for the screws and the cover.
- ◆ Secure the ei-box-cover by tightening both M3x10 screws to the xBuddy box.

STEP 21 Covering the xBuddy box

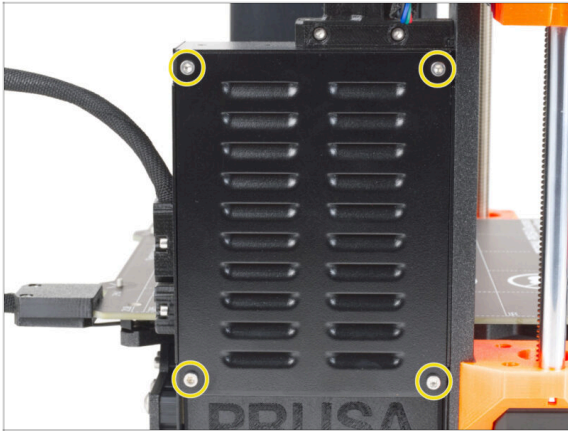

- Align the xBuddy box cover with the xBuddy box and secure it with four M3x6 screws.

STEP 22 Labels: parts preparation



For the following steps, please prepare:

- Safety label (1x)
- SN label (1x)
- xLCD sticker (1x)
- Cleaning pad (1x)

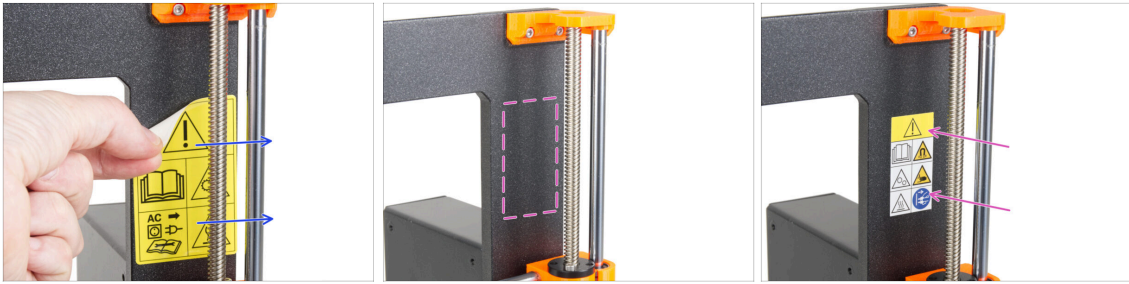
STEP 23 Upgrading the safety label (optional)

- i This step is optional, but recommended. The safety label for the MK3.5 has been updated with new symbols that align more closely with international markings.
- Peel off the old safety label from the right side of the frame.
- Using the IPA cleaning pad (included in the kit package) clean the area of adhesive residue.
- Attach the new safety label on the frame.

STEP 24 xLCD sticker (optional)

- i Applying the xLCD sticker is entirely optional, yet it serves as the finishing touch that adds a final detail to the whole assembly :).
- ⚠ This and the following steps are optional. Also, please **BE PATIENT**, smaller letters require more effort in order to be transferred and glued properly.
- Using the cleaning pad, clean the side without the circle hole on the xLCD-cover.
- Peel off a piece of the protective layer and carefully attach the label on the xLCD-cover. Maintain the label aligned with the edges of the display cover. Start on the bottom side.
- i Notice the white PRUSA lettering through the sticker. **Compare the orientation with the second picture.**
- After attaching the sticker, run your finger along the entire length of the sticker in all directions to ensure perfect adhesion.

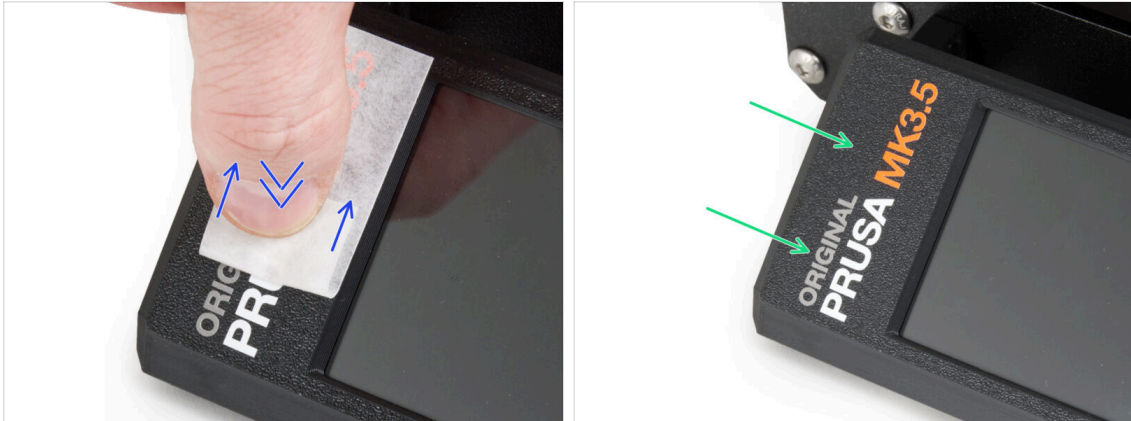
STEP 25 xLCD sticker (optional)

- ⚠ This process requires patience and care. Perfect adhesion depends on proper degreasing of the part and the ambient temperature.**
- Start slowly peeling off the application layer. Lightly press the layer onto the lettering as you peel it off. Observe whether all the letters are glued on.
 - After peeling off the application layer, check that the final look matches the picture.

STEP 26 SN label (required)

- ⚠ This step is required in order to provide a warranty! Don't throw the label away!**
- Peel off the old SN label from the printer.
 - ⓘ The SN label can be stuck on the back of the frame (above the PSU) or on the back of the rear plate.
 - Stick the label on the left side of the rear plate. Make sure, the surface is clean. Use the supplied cleaning pad.

STEP 27 Haribo time!

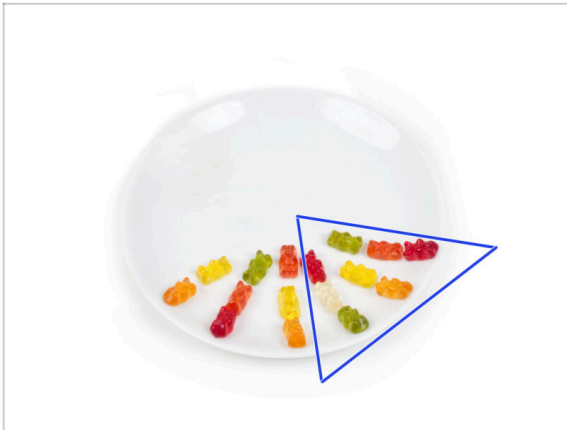

- ◆ Eat another eight gummy bears.
- ⓘ **Did you know that** the bright colors of gummy bears are achieved through the use of food coloring, which adds to their visual appeal.

STEP 28 Remaining fasteners



- ◆ To avoid the concern of having leftover nuts and screws, refer to the following list of fasteners that should remain unused from the initial package upon completing the assembly.

ⓘ Note that if you have used any spare, the final count may vary.

- ◆ **Remaining fastener items:**

- Terminal screw (1x)
- M3x4bT screw (1x)
- M3x6 screw (6x)
- M3x6r screw (1x)
- M3x8 screw (6x)
- M3x10 screw (3x)
- M3x14bT screw (1x)
- M3x18 screw (2x)
- M3n nut (1x)
- M3nN nut (4x)
- M3nS nut (9x)
- M3w washer (1x)

STEP 29 Good job!



- ◆ **You made it! Congratulations.** Your MK3.5 is almost ready for printing.
- ◆ Almost? Just one small chapter that will guide you through the calibration and self-test.
- ◆ Go to the last chapter **8. Preflight check**

8. Preflight check



STEP 1 3D Printing Handbook



- ◆ To make this chapter easier to follow, refer to the **3D Printing Handbook included in your kit** which is in English only. Or visit our latest online version in other languages.

📌 The latest version is always available at help.prusa3d.com

- 📘 The handbook contains more detailed descriptions of the important procedures in this chapter and other very useful things for future printing.

⚠️ **Read the Disclaimer and Safety instructions chapters.**

STEP 2 Attaching the print sheet

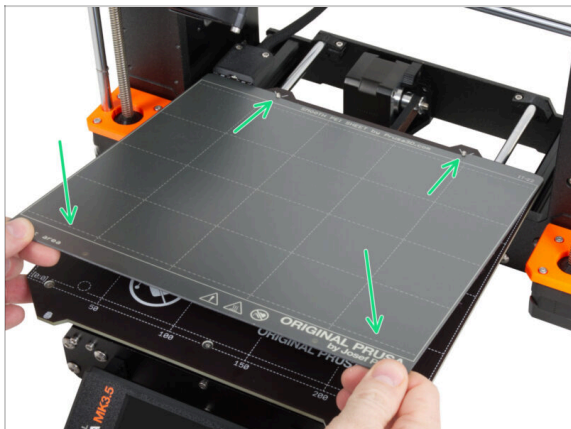

⚠️ **Make sure there is nothing on the heated bed.** The heated bed must be clean. Any dirt can damage the surface of both the heated bed and the print sheet.

- ◆ **Attach the sheet by first aligning the rear cutout with the locking pins on the back of the heated bed** (marked in orange in the picture above). Hold the sheet by the front two corners and slowly lay it down onto the heated bed - watch your fingers!

- ◆ Keep the **steel sheet** clean for optimum performance.

- ◆ #1 cause of prints detaching from the print surface is a greasy print sheet. Use **IPA (Isopropyl alcohol)** to **degrease it** if you have touched its surface before.

STEP 3 Firmware update (part 1)

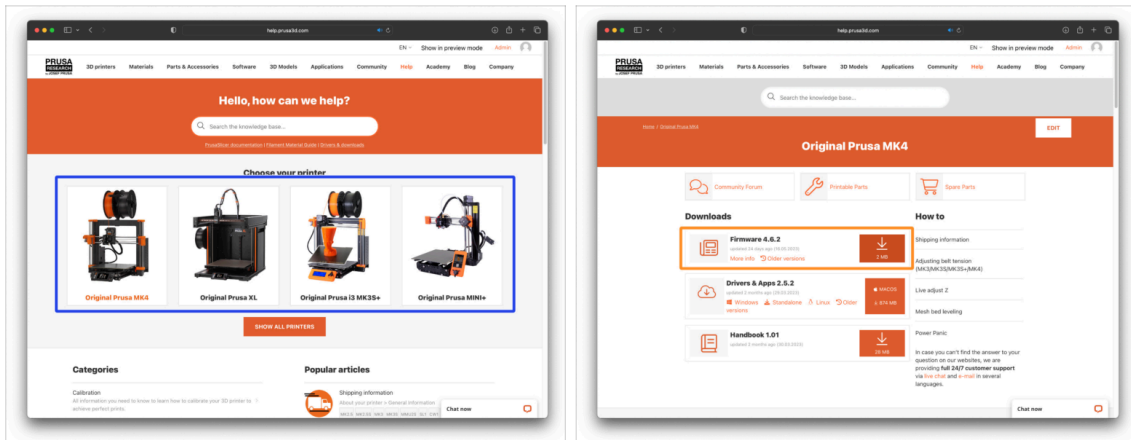

- ❗ All shipped kit units have the latest firmware version. However, it is recommended to check and possibly update it.
- 🖥️ Visit the help.prusa3d.com page.
- 🔵 From the list of printers on the page, select MK3.5.
- 🟠 Save the latest firmware file (.bff) onto the bundled USB drive.

STEP 4 Firmware update (part 2)



- 🔵 Insert the USB drive with the latest firmware file into the printer.
- 🟡 Connect the power cable and connect the printer into a wall outlet.
- 🔴 Turn the printer on using the switch on the back.
- 🟠 If the "New firmware available" screen appears, hit **FLASH** by pressing the rotary knob to upgrade to the latest firmware.
- 🖥️ If no such message appears, the printer is running the latest firmware already. Proceed to the next step.

STEP 5 Wizard - Selftest start



- ◆ After the printer starts up, the setup wizard will show up - requiring a self-test. Select **CONTINUE** to start.
- ❗ The wizard will test all important components of the printer. The whole process takes a few minutes. Some parts of the wizard require direct user interaction. Follow the instruction on the screen.
- ⚠ **NOTE:** While testing the axes, make sure that there is nothing in the printer obstructing the axes movement.
- ⚠ **WARNING:** Do not touch the printer during the self-test unless prompted! Some parts of the printer may be **HOT** and moving at high speed.
- ◆ The wizard starts with the fan check, Z-axis alignment and the X&Y axis test; all fully automatic.

STEP 6 Wizard - First layer calibration

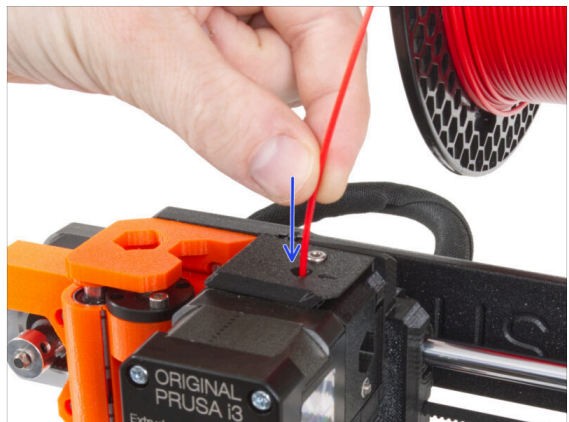

- ◆ In this part of the wizard, we will adjust the height of the first layer. Place the filament spool on the spool holder. *We recommend brightly colored PLA or PETG for easier printing and better visibility.*
- ◆ Insert the filament into the extruder and select **LOAD**.

STEP 7 Wizard - First layer calibration

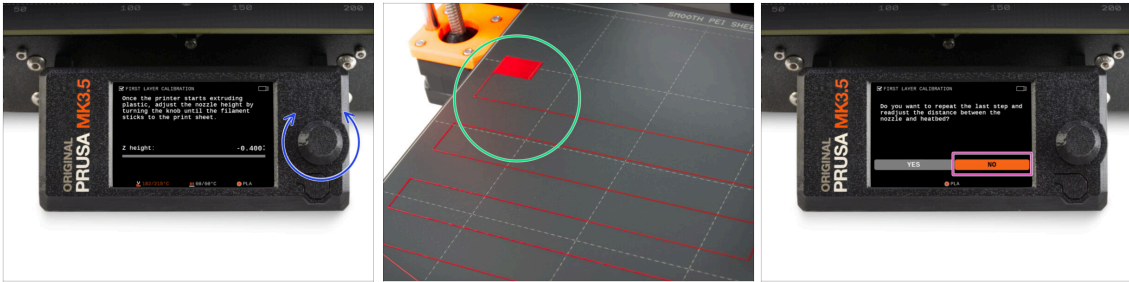

- ◆ As the extruder begins to extrude filament from the nozzle, turn the knob until you reach the ideal gap between the nozzle and the printing plate - that is, the perfect first layer.
- i Read more about the perfect first layer in the 3D Printing Handbook for MK3.5.
- ◆ When you have finished adjusting the layer, examine the result and compare it preferably with the 3D Printing Handbook.
- ◆ The printer will ask you to repeat the adjustment of the first layer procedure. In case, you achieve the best result, select **NO**.

STEP 8 Wizard complete



- ◆ **The printer is now fully calibrated.** Follow this guide to the end to load a filament in and start a test print.
- ◆ Once the Wizard finishes, the details screen will show up. **Click the knob** to continue.
- ◆ Congratulations! Your printer is finally ready to print. Hit **CONTINUE** and let's move on.

STEP 9 Reward yourself!



- It looks like you have successfully assembled and connected everything. No doubt ;). **Congratulations!** You deserve a big reward for that. Eat all the remaining gummy bears... and don't forget to share with those who supported you during the assembly.

i **Did you know that** Haribo gummy bears are one of the most important parts of the Original Prusa printers assembly instructions.

STEP 10 Printable 3D models

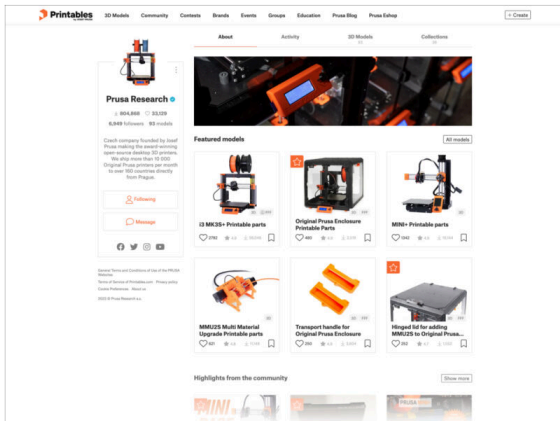

- **The printer is now ready to print!**
- The sample objects are also available on the official [Prusa Research Printables profile](#)

STEP 11 PrusaSlicer for MK3.5

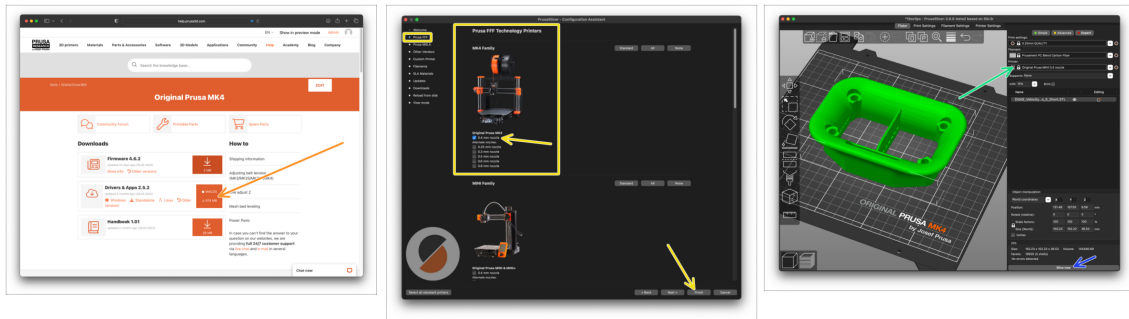

- 🛡️ Ready to print your own models?
- 📦 Visit help.prusa3d.com once again. Download and install the latest **Drivers & Apps** package onto your computer. This package includes the **PrusaSlicer** app.
- 🟡 Open the **PrusaSlicer** app. If you're running it for the first time, Configuration Wizard will show up. Visit the Prusa FFF tab in the Wizard, select **Original Prusa MK4** in the **0.4mm nozzle** version (the default nozzle size) and hit **Finish** to start using the MK4 printer profile.
- 🟢 Make sure the Original Prusa MK3.5 is selected in the Printer menu on the right, when slicing for the MK3.5.
- 🔵 **Import a model** of your choice into PrusaSlicer, adjust the settings if needed, hit **Slice** and export the G-code file onto the USB drive to print it on your MK3.5.

STEP 12 PrusaLink and Prusa Connect

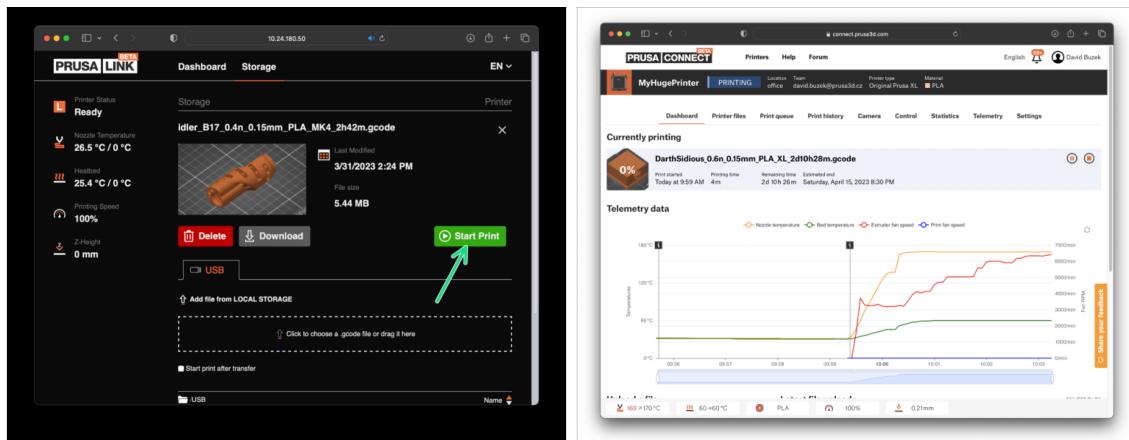

- 🛡️ Did you know you can print and control the printer over the local network with **PrusaLink** or from anywhere in the world using **Prusa Connect**?
- ⚠️ **First, read the article about PrusaLink and Prusa Connect to get general information about these services.**
- 🛡️ To start using these services, visit prusa.io/wifimk4 to set up Wi-Fi or connect your printer to a network using the wired Ethernet connection.

STEP 13 Print your first model

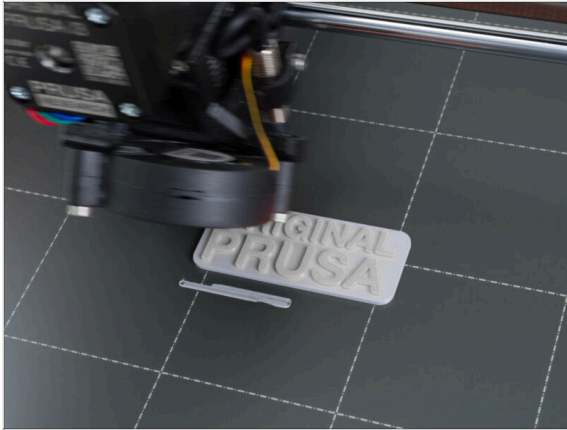

- ◆ For the first print, we have prepared a predefined test model. Download the model and upload it directly to the printer.
- ◆ [Download the sample G-code](#)
- ◆ Upload the G-code to the printer.
- ◆ i You can upload G-codes using different methods: USB drive, PrusaLink, and Prusa Connect.
- ◆ Run the print.

STEP 14 Prusa knowledge base

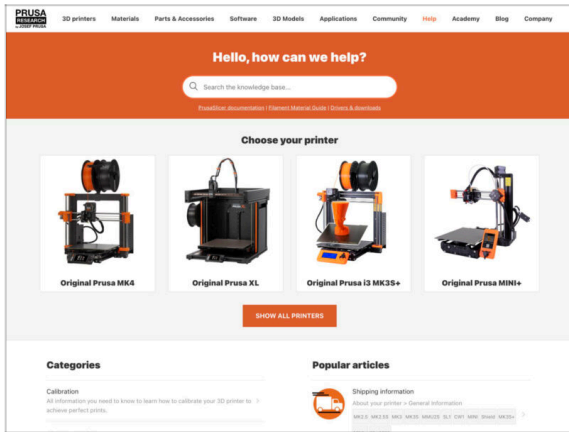

- ◆ If you encounter any problems at all, don't forget you can always check out our knowledge base at help.prusa3d.com
- ◆ We're adding new topics every day!

STEP 15 Join Printables!

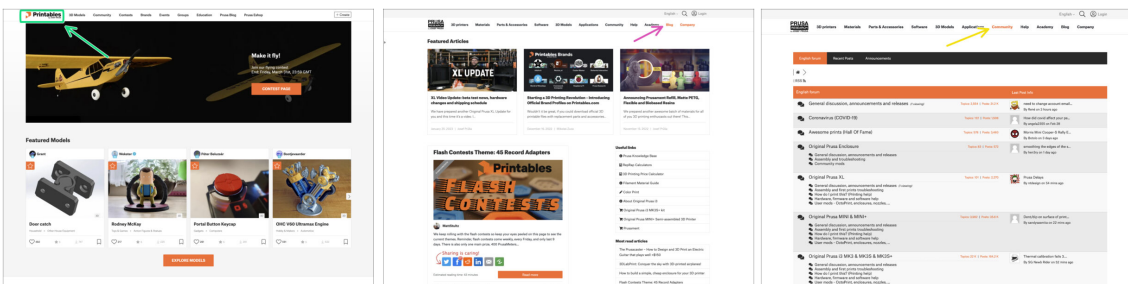

- ◆ Don't forget to join the biggest Prusa community! Download the latest models in STL or G-code tailored for your printer. Register at [Printables.com](https://printables.com)
- ◆ Looking for inspiration on new projects? Check our blog for weekly updates.
- ◆ If you need help with the build, check out our forum with a great community :-)
- ◆ i All Prusa services share one user account.

Manual changelog MK3.5 upgrade

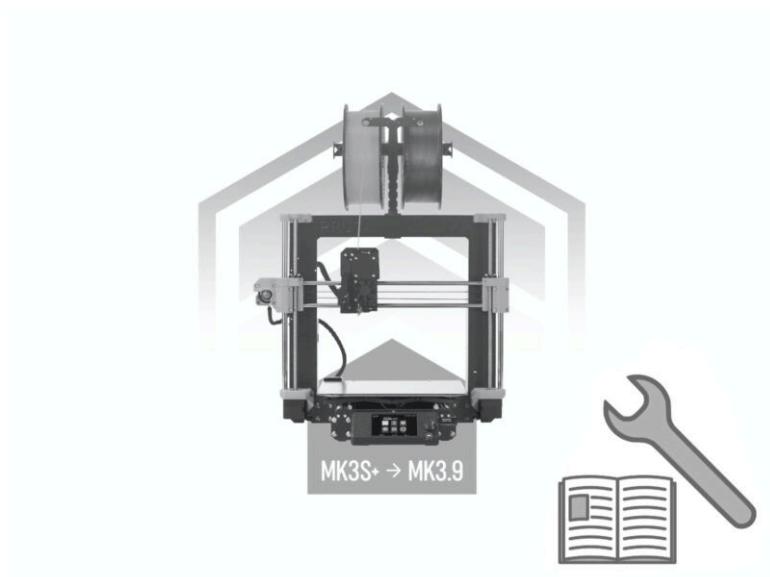

STEP 1 Version history

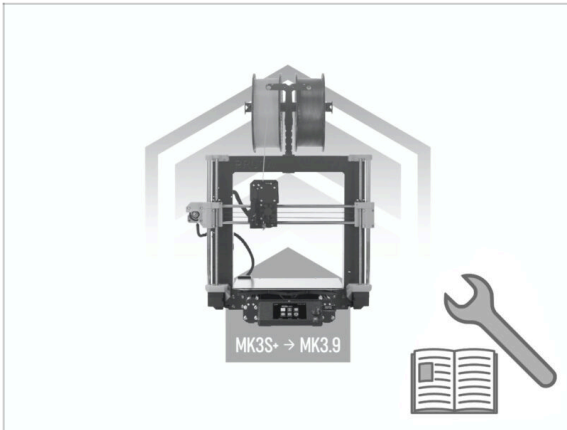

- ◆ **Versions of the MK3.5 manual:**
- ◆ 02/2024 - Initial version 1.0

