

# Spis treści

<b>1. Wprowadzenie i przygotowanie</b>	7
Krok 1 - Jak poruszać się po podręczniku	8
Krok 2 - Otwórz ilustrację w wysokiej rozdzielczości	8
Krok 3 - Before you begin	9
Krok 4 - Wszystkie wymagane narzędzia są dołączone	10
Krok 5 - Labels guide	11
Krok 6 - Spare bag	11
Krok 7 - Oznaczenie wersji części drukowanych	12
Krok 8 - Jesteśmy tu dla Ciebie!	13
Krok 9 - Pro tip: wciąganie nakrętek	14
Krok 10 - Important: Electronics protection	15
Krok 11 - Reward yourself	16
Krok 12 - Jak skutecznie ukończyć montaż	17
Krok 13 - Prepare your desk	18
Krok 14 - Important information - Buddy3D camera	18
Krok 15 - Firmware Info	19
Krok 16 - Moving the Z-axis	19
Krok 17 - Unloading filament	20
Krok 18 - Preparing the printer	20
<b>2. Demontaż drukarki</b>	21
Krok 1 - Narzędzia niezbędne w tym rozdziale	22
Krok 2 - Important information - removed parts	22
Krok 3 - Removing the top nylon rivets	23
Krok 4 - Demontaż górnego panelu	23
Krok 5 - Removing the top profile	24
Krok 6 - Removing the door	24
Krok 7 - Accessing the electronics	25
Krok 8 - Accessing the buddy board	25
Krok 9 - Unplugging the cable I.	26
Krok 10 - Unplugging the cables II.	26
Krok 11 - Removing the cables	27
Krok 12 - Pushing the cables in	27
Krok 13 - Guiding the heatbed cables in	28
Krok 14 - Releasing the main cable	28
Krok 15 - Removing the LoveBoard cover	29
Krok 16 - Disconnecting the Nextruder cables - left	29
Krok 17 - Disconnecting the Nextruder cables - top	30
Krok 18 - Disconnecting the Nextruder cables - right	30
Krok 19 - Odłączenie rurek PTFE	31
Krok 20 - Removing the Nextruder fitting	31
Krok 21 - Removing the Nextruder	32
Krok 22 - Demontaż wentylatora wydruku	32
Krok 23 - Removing the LoveBoard	33
Krok 24 - Removing the fan shroud	33
Krok 25 - Removing the side handle	34
Krok 26 - Removing the side filament sensor	34
Krok 27 - Removing the spoolholder	35
Krok 28 - Parts recap I.	35
Krok 29 - Parts recap II.	36
Krok 30 - Haribo time!	36

Krok 31 - Final step .....	37
<b>3. Upgrade osi Z .....</b>	<b>38</b>
Krok 1 - Narzędzia niezbędne w tym rozdziale .....	39
Krok 2 - Optional: Installing the Buddy3D Camera USB-C cable .....	39
Krok 3 - Demontaż pokrywy przewodów stołu grzewczego .....	40
Krok 4 - Releasing the heatbed .....	40
Krok 5 - Removing the heatbed .....	41
Krok 6 - Removing the bed spacer .....	41
Krok 7 - Tulejki dystansowe: przygotowanie części .....	42
Krok 8 - Assembling the INDX-bed-spacer-rear .....	42
Krok 9 - Mounting the INDX-bed-spacer-rear .....	43
Krok 10 - Inserting the spacer - left .....	43
Krok 11 - Securing the bed spacer - left .....	44
Krok 12 - Inserting the spacer - right .....	44
Krok 13 - Securing the bed spacer - right .....	45
Krok 14 - Offset sensor: parts preparation .....	45
Krok 15 - Mounting the INDX OffsetSensor .....	46
Krok 16 - Connecting the offset sensor cable .....	46
Krok 17 - Securing the offset sensor assembly .....	47
Krok 18 - Guiding the offset sensor cable .....	47
Krok 19 - Securing the offset sensor cable .....	48
Krok 20 - Removing the Bed-cable-cover-bottom .....	48
Krok 21 - Heatbed cable covers: parts preparation .....	49
Krok 22 - Heatbed cable covers: parts preparation II .....	49
Krok 23 - Assembling the Bed-cable-cover-bottom .....	50
Krok 24 - Inserting the heatbed .....	50
Krok 25 - Securing the heatbed .....	51
Krok 26 - Owinięcie przewodów podgrzewanego stołu .....	51
Krok 27 - Montaż pokrywy przewodów stołu grzewczego .....	52
Krok 28 - Guiding the heatbed cable bundle I. ....	52
Krok 29 - Guiding the heatbed cable bundle II. ....	53
Krok 30 - Owinięcie przewodów owijką tekstylną .....	53
Krok 31 - Removing the Bed-stop-rear .....	54
Krok 32 - INDX-C1-Bed-stop-rear: parts preparation .....	54
Krok 33 - Assembling the Bed-stop-rear .....	55
Krok 34 - Installing the new Bed-stop-rear .....	55
Krok 35 - Securing the Bed-stop-rear .....	56
Krok 36 - Connecting the RGB LED + offset sensor cables .....	56
Krok 37 - Podłączenie przewodów stołu grzewczego .....	57
Krok 38 - Haribo time .....	57
Krok 39 - Done .....	58
<b>4. Głowica INDX i boczne czujniki filamentu .....</b>	<b>59</b>
Krok 1 - Narzędzia niezbędne w tym rozdziale .....	60
Krok 2 - Loosening the belts .....	61
Krok 3 - Releasing the belts .....	61
Krok 4 - Gantry aligner tool: parts preparation .....	62
Krok 5 - Installing the Gantry-aligner-tool - right .....	62
Krok 6 - Installing the Gantry-aligner-tool - left .....	63
Krok 7 - Wyrównanie prowadnicy liniowej .....	63
Krok 8 - Removing the Gantry-aligner-tool .....	64
Krok 9 - Print head mount: parts preparation .....	64
Krok 10 - Securing the belts .....	65
Krok 11 - Installing the Head-mounting-plate .....	65
Krok 12 - Adjusting the belts .....	66

Krok 13 - INDX Toolhead assembly: Parts preparation .....	66
Krok 14 - Attaching the cable strain relief .....	67
Krok 15 - INDX Toolhead: parts preparation .....	67
Krok 16 - Mounting the INDX Toolhead .....	68
Krok 17 - Kanał wentylatora: przygotowanie części .....	68
Krok 18 - Attaching the Fan-shroud .....	69
Krok 19 - Inserting the nut .....	69
Krok 20 - Wentylator wydruku: przygotowanie części .....	70
Krok 21 - Installing the print fan .....	70
Krok 22 - Podłączenie wentylatora wydruku .....	71
Krok 23 - INDX head cable: parts preparation I. ....	71
Krok 24 - INDX head cable: parts preparation II. ....	72
Krok 25 - Guiding the head cable .....	72
Krok 26 - Inserting the Nylon .....	73
Krok 27 - Connecting the head cable .....	73
Krok 28 - Attaching the head cable .....	74
Krok 29 - Securing the swing arm clip .....	75
Krok 30 - Securing the main cable .....	75
Krok 31 - Installing the Head cable clip .....	76
Krok 32 - Connecting the head cable: parts preparation .....	76
Krok 33 - Opaski zaciskowe .....	77
Krok 34 - Connecting the head cable .....	77
Krok 35 - Securing the cables .....	78
Krok 36 - Haribo time! .....	78
Krok 37 - INDX PTFE holders: parts preparation .....	79
Krok 38 - Installing the PTFE-holder-left .....	79
Krok 39 - Installing the PTFE-holder-right .....	80
Krok 40 - Side filament sensors: parts preparation .....	80
Krok 41 - Inserting the sleeves .....	81
Krok 42 - Inserting the collets .....	81
Krok 43 - Installing the magnets .....	82
Krok 44 - Assembling the FS: parts preparation I .....	82
Krok 45 - Assembling the FS: parts preparation II .....	83
Krok 46 - Inserting the steel balls .....	83
Krok 47 - Attaching the magnets .....	84
Krok 48 - Assembling the FS-top left .....	84
Krok 49 - Assembling the FS-top right .....	85
Krok 50 - Covering the filament sensor - left .....	85
Krok 51 - Covering the filament sensor - right .....	86
Krok 52 - PTFE tubes - left side: parts preparation .....	86
Krok 53 - Preparing the filament sensor - left .....	87
Krok 54 - Mounting the filament sensor - left .....	87
Krok 55 - Connecting the PTFE tube - left .....	88
Krok 56 - PTFE measurement: parts preparation .....	88
Krok 57 - Attaching the PTFE tubes - left .....	89
Krok 58 - Measurement info .....	89
Krok 59 - Inserting the PTFE tubes (position 1,2) .....	90
Krok 60 - Inserting the PTFE tubes (position 3,4) .....	90
Krok 61 - PTFE tubes - right side: parts preparation .....	91
Krok 62 - Preparing the filament sensor - right .....	91
Krok 63 - Mounting the filament sensor - right .....	92
Krok 64 - Connecting the PTFE tube - right .....	92
Krok 65 - Attaching the PTFE tubes - left .....	93
Krok 66 - Inserting the PTFE tubes (position 5,6) .....	93
Krok 67 - Inserting the PTFE tubes (position 7,8) .....	94

Krok 68 - Connecting the filament sensor cable .....	94
Krok 69 - Haribo time! .....	95
Krok 70 - Done .....	95
<b>5. Uchwyty szpuli i doki narzędzi .....</b>	<b>96</b>
Krok 1 - Narzędzia niezbędne w tym rozdziale .....	97
Krok 2 - Side handle: parts preparation .....	97
Krok 3 - Installing the side handle .....	98
Krok 4 - Dock fan cable: parts preparation .....	98
Krok 5 - Dock fan head cable .....	99
Krok 6 - Securing the zip ties I. ....	99
Krok 7 - Securing the zip ties II. ....	100
Krok 8 - Attaching the dock fan cable .....	100
Krok 9 - Leading the dock fan cable I. ....	101
Krok 10 - Leading the dock fan cable II. ....	101
Krok 11 - Securing the dock fan cable .....	102
Krok 12 - Tightening the zip ties I. ....	102
Krok 13 - Tightening the zip ties II. ....	103
Krok 14 - Nozzle cleaner: parts preparation I. ....	104
Krok 15 - Nozzle cleaner: parts preparation II. ....	104
Krok 16 - Assembling the Wiper-lock .....	105
Krok 17 - Securing the Wiper-lock .....	105
Krok 18 - Installing the Wiper-adjuster .....	106
Krok 19 - Inserting the wiper blocks .....	106
Krok 20 - Installing the nozzle cleaner .....	107
Krok 21 - Electronics covers: parts preparation .....	107
Krok 22 - Securing the cables .....	108
Krok 23 - Wiring check .....	108
Krok 24 - Montaż pokrywy obudowy xBuddy .....	109
Krok 25 - Montaż tylnej pokrywy .....	109
Krok 26 - Bottom puck holders: parts preparation .....	110
Krok 27 - Assembling the bottom puck holders .....	110
Krok 28 - Removing the screws - right .....	111
Krok 29 - Mounting the bottom puck holders - right .....	111
Krok 30 - Securing the front Puck-holder bottom - right I. ....	112
Krok 31 - Securing the front Puck-holder bottom - right II. ....	112
Krok 32 - Securing the rear Puck-holder bottom - right I. ....	113
Krok 33 - Securing the rear Puck-holder bottom - right II. ....	113
Krok 34 - Removing the screws - left .....	114
Krok 35 - Mounting the bottom puck holders - left .....	114
Krok 36 - Securing the front Puck-holder bottom - left I. ....	115
Krok 37 - Securing the front Puck-holder bottom - left II. ....	115
Krok 38 - Securing the rear Puck-holder bottom - left I. ....	116
Krok 39 - Securing the rear Puck-holder bottom - left II. ....	116
Krok 40 - Tilting the printer .....	117
Krok 41 - Finishing the rear puck holder bottom - left I. ....	118
Krok 42 - Finishing the rear puck holder bottom - left II. ....	118
Krok 43 - Finishing the front puck holder bottom - left I. ....	119
Krok 44 - Finishing the front puck holder bottom - left II. ....	119
Krok 45 - Finishing the rear puck holder bottom - right I. ....	120
Krok 46 - Finishing the rear puck holder bottom - right II. ....	120
Krok 47 - Finishing the front puck holder bottom - right I. ....	121
Krok 48 - Finishing the front puck holder bottom - right II. ....	121
Krok 49 - Top puck holders: parts preparation .....	122
Krok 50 - Assembling the puck holder top .....	122

Krok 51 - Removing the nylon rivets - right .....	123
Krok 52 - Mounting the front puck holder top - right .....	123
Krok 53 - Securing the front puck holder top - right .....	124
Krok 54 - Mounting the rear puck holder top - right .....	124
Krok 55 - Securing the rear puck holder top - right .....	125
Krok 56 - Removing the nylon rivets - left .....	125
Krok 57 - Mounting the front puck holder top - left .....	126
Krok 58 - Securing the front puck holder top - left .....	126
Krok 59 - Mounting the rear puck holder top - left .....	127
Krok 60 - Securing the rear puck holder top - left .....	127
Krok 61 - Dock fan: parts preparation .....	128
Krok 62 - Assembling the dock fan .....	128
Krok 63 - Attaching the FunFan board .....	129
Krok 64 - Attaching the dock fan .....	129
Krok 65 - Securing the dock fan .....	130
Krok 66 - Haribo time! .....	130
Krok 67 - Tool holder: parts preparation .....	131
Krok 68 - Assembling the tool holder .....	131
Krok 69 - Installing the tool holders .....	132
Krok 70 - Nozzle seal holder: parts preparation .....	132
Krok 71 - Assembling the nozzle seal .....	133
Krok 72 - Assembling the Nozzle-seal-holder .....	133
Krok 73 - Installing the nozzle parking plates .....	134
Krok 74 - Ventilation lever: parts preparation .....	134
Krok 75 - Assembling the ventilation lever .....	135
Krok 76 - Top cover: parts preparation I. ....	135
Krok 77 - Top cover: parts preparation II. ....	136
Krok 78 - Attaching the hinge covers .....	136
Krok 79 - Attaching the grill .....	137
Krok 80 - Attaching the left cover lock .....	137
Krok 81 - Attaching the right cover lock .....	138
Krok 82 - Top cover back: parts preparation .....	138
Krok 83 - Attaching the top cover back .....	139
Krok 84 - Attaching the hinge base - left .....	139
Krok 85 - Attaching the hinge base - right .....	140
Krok 86 - Attaching the top cover I. ....	140
Krok 87 - Attaching the top cover II. ....	141
Krok 88 - INDX Nozzle tool: parts preparation .....	141
Krok 89 - Attaching the tooldock .....	142
Krok 90 - Securing the tooldock .....	142
Krok 91 - Montaż panelu LED .....	143
Krok 92 - Optional: Installing the Buddy3D Camera .....	143
Krok 93 - Connecting the INDX Nozzle tools (positions 1-4) .....	144
Krok 94 - Docking the tools (positions 1-4) .....	144
Krok 95 - Connecting the INDX Nozzle tools (positions 5-8) .....	145
Krok 96 - Docking the tools (positions 5-8) .....	145
Krok 97 - Checking the tubes .....	146
Krok 98 - Offset sensor cover: parts preparation .....	146
Krok 99 - Covering the offset sensor .....	147
Krok 100 - Panel drzwi: przygotowanie części .....	147
Krok 101 - Montaż panelu drzwi .....	148
Krok 102 - Haribo time ! .....	148
Krok 103 - That's it .....	149
<b>6. Kontrola przed uruchomieniem .....</b>	<b>150</b>

Krok 1 - Montaż uchwytu szpuli: przygotowanie części .....	151
Krok 2 - Locking the spool holders .....	151
Krok 3 - Położenie arkusza na stole .....	152
Krok 4 - Firmware update .....	152
Krok 5 - Włączenie drukarki .....	153
Krok 6 - Konfiguracja drukarki: Intro .....	153
Krok 7 - Konfiguracja drukarki: Połączenie sieciowe .....	154
Krok 8 - Wizard: Intro .....	154
Krok 9 - Wizard: Door sensor calibration .....	155
Krok 10 - Wizard: Belt tensioning .....	155
Krok 11 - Wizard: Dock calibration (part 1) .....	156
Krok 12 - Wizard: Dock calibration (part 2) .....	156
Krok 13 - Wizard: Dock calibration (part 3) .....	157
Krok 14 - Wizard: Loadcell Test .....	158
Krok 15 - Wizard: Fan test .....	158
Krok 16 - Wizard: Tool offsets calibration .....	159
Krok 17 - Wizard: Nozzle cleaner calibration .....	159
Krok 18 - Wizard: Nozzle cleaner calibration Z/X-axis .....	160
Krok 19 - Wizard: Nozzle cleaner calibration Y-axis .....	161
Krok 20 - Wizard: Filament sensors calibration .....	162
Krok 21 - Wizard complete .....	162
Krok 22 - Haribo time! .....	163
Krok 23 - Prusa knowledge base .....	163
Krok 24 - Give us feedback .....	164
Krok 25 - Join Printables! .....	164

# 1. Wprowadzenie i przygotowanie



## KROK 1 Jak poruszać się po podręczniku

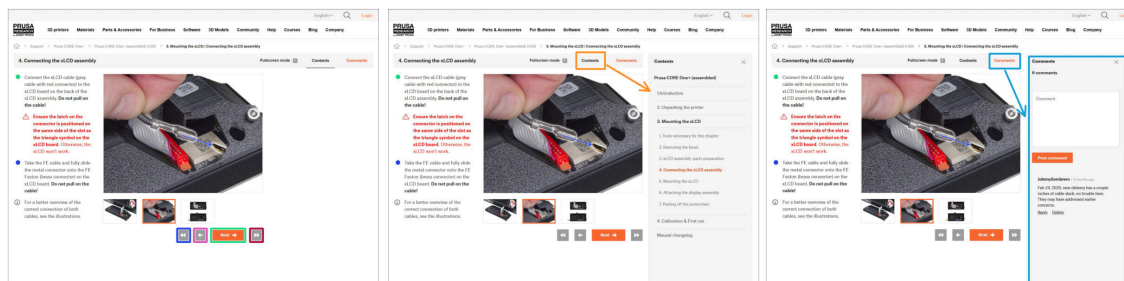

Użyj graficznych przycisków nawigacyjnych w prawym dolnym rogu lub klawiszy strzałek na klawiaturze:

- **Przycisk z podwójną strzałką w lewo / Strzałka w górę** - przejście do poprzedniego etapu.
- **Przycisk ze strzałką w lewo/Strzałka w lewo** - przejście do poprzedniego obrazu lub do poprzedniego kroku, jeśli jest to pierwszy obraz na tym etapie.
- **Przycisk Dalej / Strzałka w prawo** - przejście do następnego obrazu lub do następnego etapu, jeśli jest to ostatnia ilustracja na danym etapie.
- **Przycisk z podwójną strzałką w prawo / Strzałka w dół** - przejście do kolejnego etapu.
- Kliknij **Spis treści**, aby rozwinąć pełną listę etapów zawartych w tym przewodniku. Umożliwia to przejście do dowolnego z nich niezależnie od kolejności.
- Kliknij **Komentarze**, aby otworzyć dyskusję dot. danego etapu lub zostawić swoją opinię.

## KROK 2 Otwórz ilustrację w wysokiej rozdzielczości

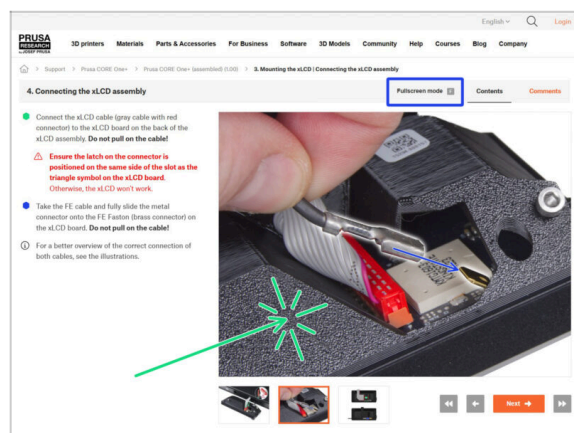

- Podczas przeglądania przewodnika na stronie [help.prusa3d.com](http://help.prusa3d.com), możesz otworzyć oryginalne ilustracje w wysokiej rozdzielczości.
- Po prostu kliknij ilustrację, aby otworzyć ją w wysokiej rozdzielczości, co pozwoli Ci zobaczyć dodatkowe szczegóły.
- Kliknij **Pełny ekran** lub naciśnij klawisz F, aby zmaksymalizować stronę i skupić się całkowicie na instrukcjach.

## KROK 3 Before you begin



The **INDX Conversion kit is compatible with the Prusa CORE One and CORE One+**. This guide uses the CORE One+; some disassembly steps may vary between models.

- The required steps depend on your printer's current state:
  - **If your CORE One+ is brand new** and still unboxed, first follow the CORE One+ Unpacking & First run guide before installing the Bondtech INDX conversion.
  - **If you already use the CORE One+** and purchased only the INDX Conversion kit (Founders Edition) you can continue with this guide.

## KROK 4 Wszystkie wymagane narzędzia są dołączone

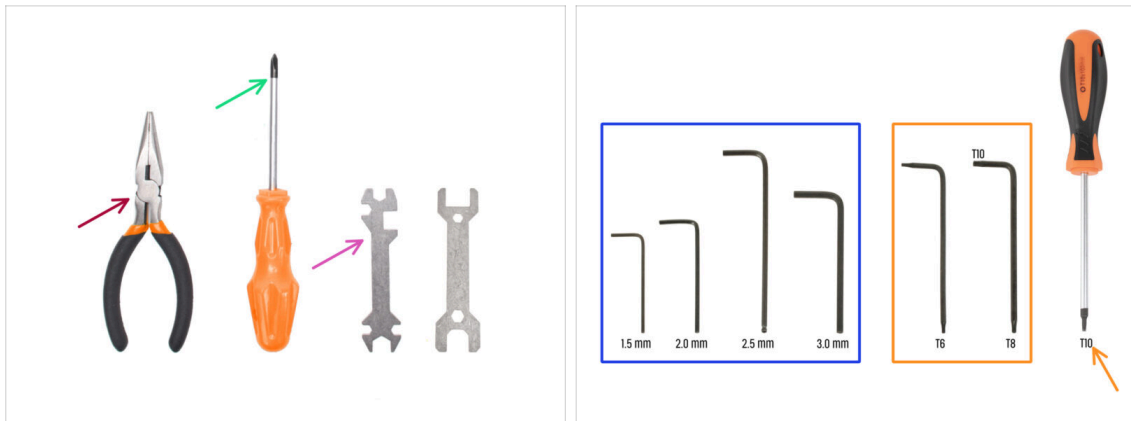

### ● **Narzędzia potrzebne do tej modernizacji:**



Use the tools originally included with your CORE One+ / CORE One printer.

- Szczypce spiczaste (1x)
- Wkrętak krzyżakowy PH2 (1x)
- Klucz uniwersalny (1x)
- Zestaw kluczy imbusowych
- Zestaw kluczy Torx

ⓘ The **T10 screwdriver is included only with kit versions** and may not be available with fully assembled printers.  
It is not required, but may be more convenient in some steps.

## KROK 5 Labels guide

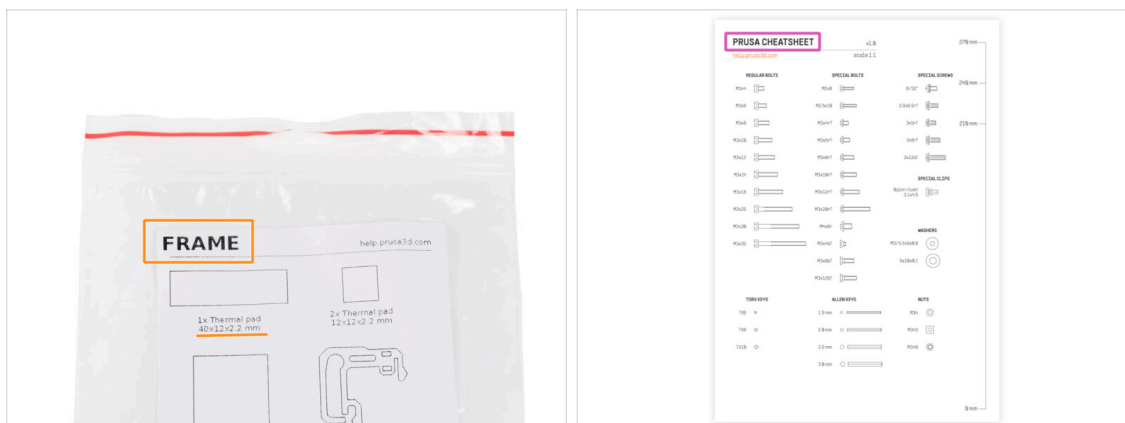

- Wszystkie pudełka i woreczki z częściami potrzebnymi do budowy są oznaczone etykietami.
- Etykiety zawierają listę zawartości i liczbę części.
- Arkusz [prusa.io/C1-INDX-cheatsheet](http://prusa.io/C1-INDX-cheatsheet) jest dostępny na naszej stronie. Wydrukuj go w skali 100% - nie zmieniaj skalowania, inaczej nie zadziała.
- ⓘ Dla weteranów montażu sprzętu PRUSA: elementy złączne są podzielone na poszczególne woreczki zgodnie z ich typem. Nie są podzielone na paczki dla poszczególnych rozdziałów, jak przy poprzednich drukarkach.
- 📌 Instrukcje będą wskazywać opakowanie dla każdej części, z wyjątkiem elementów złącznych, które zawsze znajdują się w jednym, dedykowanym pakiecie.

## KROK 6 Spare bag



- Zapasowe elementy złączne są dołączone do każdego woreczka z tymi elementami. Liczba sztuk zapasowych jest zawsze wliczona w całkowitą liczbę podaną na opakowaniu.
- Podobnie z innymi elementami - w ich torebkach możesz znaleźć jedną dodatkową sztukę.

## KROK 7 Oznaczenie wersji części drukowanych



- ◆ Większość części drukowanych jest oznaczona wersją.
  - ◆ **Seria E, F i Gx** (np. E1) - są to części drukowane na farmie Prusa Research i wysyłane w zestawie.
  - ◆ **Seria R, S i Tx** (np. R1) - to części dostępne do pobrania z naszej strony [printables.com](https://www.prusa3d.com/3d-printables/). Są identyczne do tych drukowanych przez nas.
  - ◆ Numery oznaczają drobne zmiany, które zazwyczaj dotyczą niewielkich poprawek konstrukcyjnych. Jeśli w instrukcji znajdziesz inne oznaczenie, niż na Twoich częściach (np. inna wersja na ilustracji), to nie przejmuj się - nie ma to wpływu na montaż, a wszystkie wersje są w pełni kompatybilne.
- ⓘ Jeśli podczas montażu napotkasz problemy związane z konkretną wydrukowaną częścią, znajdź etykietę i prześlij ją naszemu zespołowi pomocy technicznej.

## KROK 8 Jesteśmy tu dla Ciebie!

The screenshot shows the Prusa 3D printer manual website. The main content area displays step 4, 'Connecting the xLCD assembly', with instructions and images. A 'Comments' section is visible on the right, showing a user's comment and a response. A pink arrow points from the 'Chat now' button to the 'SUBMIT' button.

- 🛡️ Problemy z instrukcją, brakuje śrubek lub część drukowana jest pęknięta? **Powiedz nam o tym!**
- 🛡️ Możesz skontaktować się z nami w następujący sposób:
  - 🔵 Komentując poszczególne etapy instrukcji.
  - 🟣 Przez nasz Live Chat czynny 24/7 na prusa3d.com
  - 🛡️ Przez e-mail [info@prusa3d.com](mailto:info@prusa3d.com)

## KROK 9 Pro tip: wciąganie nakrętek



- Części drukowane w 3D są bardzo dokładne, jednak mogą wystąpić pewne odchyłki. To samo dotyczy nakrętek.
- Może się zdarzyć, że nakrętka nie będzie chciała wejść w gniazdo lub będzie z niego wypadać. Zobaczmy, co zrobić w takich przypadkach:
  - **Nakrętka nie chce wejść w gniazdo:** użyj śruby z gwintem na całej długości (np. M3x10, M3x18) i wkręć ją z drugiej strony otworu. Nakrętka będzie wciągana w gniazdo podczas dokręcania. Wykręć śrubę po dociągnięciu nakrętki.
  - **Nakrętka wypada:** przyklej kawałek taśmy, aby tymczasowo przytrzymać nakrętkę na miejscu i odklej ją, gdy wkręcisz śrubę. *Nie zalecamy używania kleju, ponieważ może on zanieczyścić gwint, co uniemożliwi prawidłowe dokręcenie śruby.*
- Podobizna Josefa oznacza, że w tym momencie zalecamy "technikę wciągania nakrętki" ;)
- ⓘ Części na ilustracjach są pokazane jako przykład.

## KROK 10 Important: Electronics protection

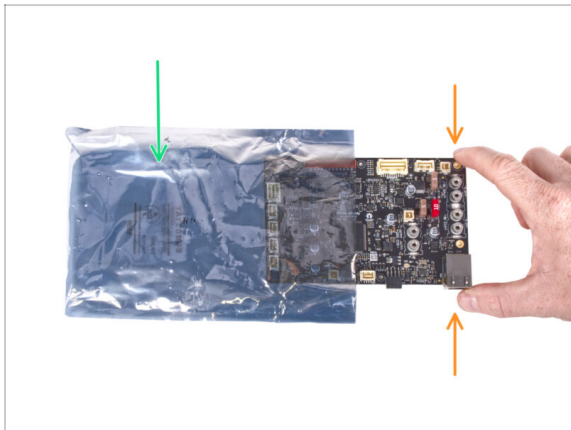

**⚠ UWAGA: Chronić elektronikę przed wyładowaniami elektrostatycznymi (ESD). Nie wyciągaj elementów elektronicznych z torebek antystatycznych do czasu ich użycia!**

● Poniżej znajdziesz kilka **porad dotyczących ochrony elektroniki**:

- **Przechowuj elektronikę w torebkach antystatycznych** do czasu, aż instrukcja wskaże konieczność ich montażu.
- **Trzymaj płytki tylko za krawędzie**, gdy się nimi posługujesz. Nie dotykaj czipów, kondensatorów ani innych części elektroniki.
- **Zanim dotkniesz jakiegokolwiek elementu elektronicznego**, dotknij jakiegokolwiek przewodzącej (np. stalowej) konstrukcji, aby rozładować swój ładunek elektrostatyczny.
- Zachowaj szczególną ostrożność w **pomieszczeniach z dywanami i wykładzinami**, ponieważ są one źródłem ładunków elektrostatycznych.
- Ubrania wełniane i z pewnych syntetycznych włókien mogą łatwo gromadzić ładunki elektrostatyczne. Podczas montażu bezpieczniej jest nosić odzież bawełnianą.

## KROK 11 Reward yourself



- Konwersja CORE One+ na INDX CORE One+ to satysfakcjonujące doświadczenie, dlatego ważne jest, aby nagradzać się po przejściu każdego ważnego etapu. **Właśnie po to dołączyliśmy paczkę misiów Haribo!**
- Nie zjedz wszystkich żelków na raz zanim zaczniesz pracę! Nieprzestrzeganie instrukcji będzie mieć poważne konsekwencje, ponieważ zbieramy właśnie zespół taktyczny Prusa Haribo na takie akcje.
- Po latach badań naukowych udało nam się znaleźć rozwiązanie. **W instrukcji, oprócz montażu, znajdziesz również wskazówki dotyczące dokładnego spożycia żelków.**
- Przed użyciem skonsultuj się ze sprzedawcą w najbliższym sklepie ze słodyczami, gdyż każdy słodycz niewłaściwie stosowany zagraża Twojemu życiu lub zdrowiu ;)
- ⚠ **Cut open the bag of the Prusa Haribo carefully so the gummy bears don't spill onto the table. This step is very important!**
- ⚠ **Schowaj na ten czas paczkę misiów Haribo! Z naszego doświadczenia wynika, że niepilnowane żelki potrafią zniknąć w niewyjaśnionych okolicznościach. Potwierdzają to liczne przypadki na całym świecie.**

## KROK 12 Jak skutecznie ukończyć montaż

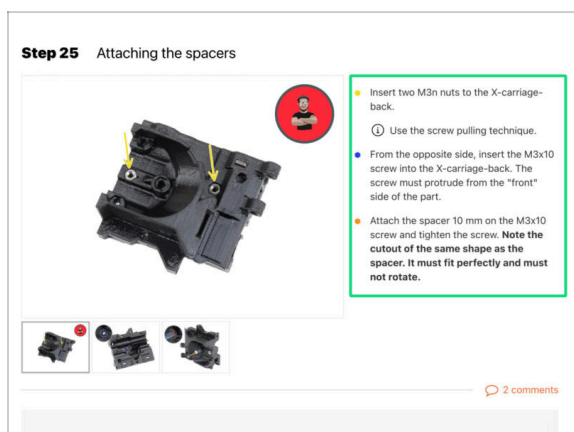

**⚠** Aby poprawnie przeprowadzić konwersję do INDX, przestrzegaj dokładnie poniższych instrukcji:

- 🟢** **Zawsze najpierw przeczytaj całą instrukcję dot. danego etapu** - pomoże Ci w pełni zrozumieć, co musisz zrobić. Nie przycinaj niczego, dopóki instrukcja o tym nie powie!!!
- ⬛** **Do not follow pictures only!** It is not enough; the written instructions are as brief as they could be. **Read them.**
- ⓘ** Przeczytaj komentarze od innych użytkowników - są świetnymi źródłami pomysłów. My również je czytamy i zawieramy w instrukcjach, aby poprawić proces montażu.
- ⬛** **Nie stosuj zbyt dużej siły**- części drukowane są wytrzymałe, ale nie są niezniszczalne. Jeśli coś nie pasuje, to dwa razy sprawdź, co robisz.
- ⚠** **Nie należy wyrzucać żadnych części, chyba że pojawi się odpowiednia instrukcja.**
- ⬛** **Najważniejsze: ciesz się składaniem i baw się dobrze.**

## KROK 13 Prepare your desk

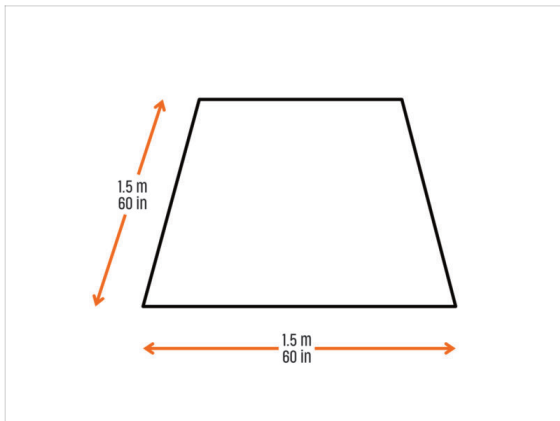

- **Zrób miejsce w obszarze pracy.** Upewnij się, że masz wystarczająco dużo przestrzeni. Czysty, płaski stół warsztatowy pozwoli Ci osiągnąć zamierzone rezultaty.
  - **Niech stanie się światło!** Pracuj w dobrze oświetlonym miejscu. Prawdopodobnie przyda się kolejna lampa lub nawet dodatkowa latarka.
  - Przygotuj coś do przechowywania foliowych worków i materiałów opakowaniowych, aby móc je później poddać recyklingowi. Upewnij się, że nie wyrzucasz żadnych ważnych części.
  - Zalecana jest powierzchnia robocza o wymiarach min. 1,5 x 1,5 metra (60 x 60 cali).
- ⚠ **We highly recommend placing a soft pad on your workbench. Some sheet metal parts have sharp edges that could scratch the surface.**
- 📘 Możesz do tego użyć kartonu.

## KROK 14 Important information - Buddy3D camera



- If your printer is equipped with a Buddy3D camera, remove it before starting this procedure.
  - The Buddy3D camera is magnetically attached. Simply remove it and disconnect the cable.
  - There is no need to disconnect the camera cable.
- 📌 Place the camera in a safe location during the procedure. We recommend covering the lens with a protective cap.

## KROK 15 Firmware Info



Before you begin, make sure your printer is running **firmware version 6.5.3** or newer.

- On the printer display, go to **Info** -> **Version Info** -> **Firmware Version** to check your current version.
  - If your printer is already running firmware 6.5.3 or newer, continue to the next step.
- ⚠ **If your firmware is older, update it before starting the upgrade.**
  - Follow our dedicated firmware update guide for detailed instructions How to update firmware.
  - Once the firmware update is complete, return to this guide and continue.

## KROK 16 Moving the Z-axis



Zanim zaczniesz, ustaw stół grzewczy w pozycji, która umożliwia dostęp do niego.



**During this step, keep the printer door closed and do not reach inside.**

- In the printer menu, go to **Control** -> **Auto Home**.
- After Auto Home, move the heatbed down via **Control** -> **Move Axis** -> **Move Z** until the highlighted screws and the underside of the heatbed are accessible (minimum **180 mm**).
- ⓘ This ensures both areas will be comfortably accessible during the procedure, as they will need to be handled later in the manual.

## KROK 17 Unloading filament



- Upewnij się, że w drukarce nie ma załadowanego filamentu.
- Rozładuj filament. Przejdź do menu **Filament** i wybierz **Rozładuj filament**.
- Rozładuj filament z drukarki.
- Remove the filament spool from the printer.

## KROK 18 Preparing the printer



- ⚠ Przed rozpoczęciem upewnij się, że **drukarka jest schłodzona** do temperatury otoczenia.
- Wyłącz drukarkę za pomocą przełącznika z tyłu.
- Odłącz drukarkę od zasilania.
- Zdejmij płytę stalową stołu.
- Umieść puste kartonowe pudełko (np. po Prusamencie) na stole grzewczym, aby go zabezpieczyć na wypadek upadku jakichkolwiek elementów.
- Remove the **USB drive** to prevent damage while handling the printer.
- OK, jesteśmy gotowi. Zaczynamy! Przejdź do rozdziału **2. Demontaż drukarki**.

## 2. Demontaž drukarki



## KROK 1 Narzędzia niezbędne w tym rozdziale

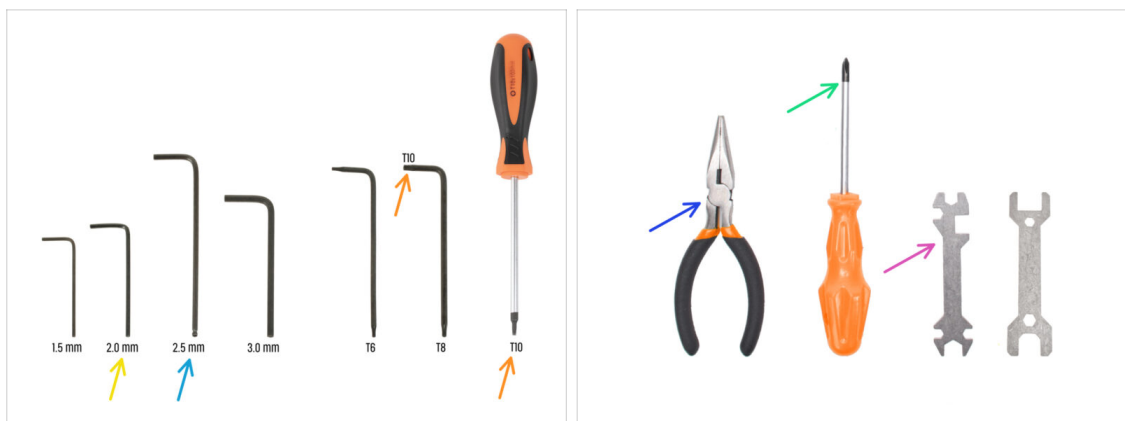

### Do tego rozdziału przygotuj:

- 2.0mm Allen key
- Klucz imbusowy 2,5 mm
- Klucz / śrubokręt T10
- Szczypce spiczaste (cząłki boczne) *lub* nożyce do odcięcia opasek zaciskowych
- Wkrętak krzyżakowy PH2
- Universal wrench

## KROK 2 Important information - removed parts



**!** Do not discard any printer parts during this procedure.

● Some of the removed printer parts will be reused later and are listed at the end of this chapter.

● From the fasteners, we recommend **keeping all removed screws.**

**i** Some of the removed screws will be reused during the conversion. We recommend labeling these as you set them aside.

### KROK 3 Removing the top nylon rivets



- ◆ There are four nylon rivets on the top panel that secure it. Remove these nylon rivets as follows:
  - ◆ Używając szczypiec spiczastych, ostrożnie chwyć główkę nitu końcówką i wyciągnij ją.
  - ⚠ **Zachowaj ostrożność, aby nie uszkodzić górnego panelu.**
  - ◆ Jeśli dolna część nitu pozostała w panelu, chwyć ją szczypcami i również ją wyjmij.

### KROK 4 Demontaż górnego panelu



- ◆ Remove the top panel from the printer.
- ⓘ You will not need the top panel for this upgrade.

## KROK 5 Removing the top profile

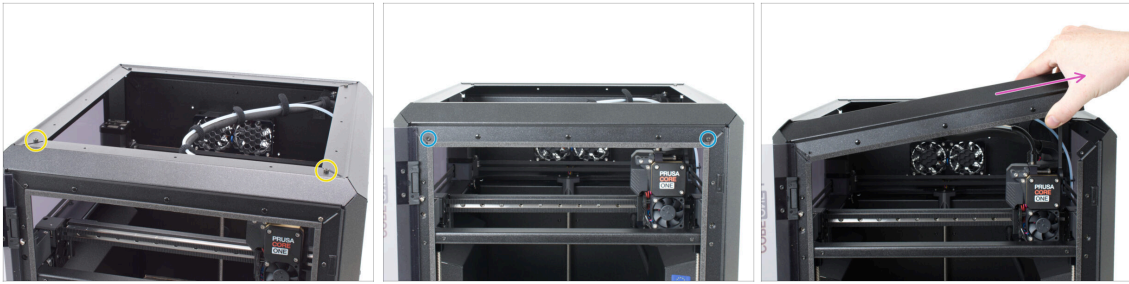

- Using the 2.5mm Allen key, remove the two M3x4 screws from the top front panel.
- From the front, use a T10 key to remove the two M3x4rT screws.
- Carefully remove the top profile from the printer.

## KROK 6 Removing the door

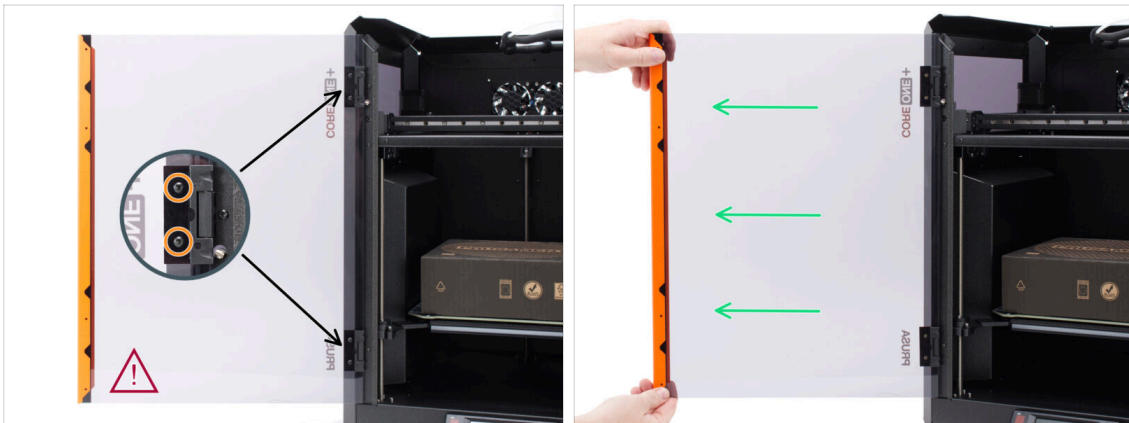

- ⓘ We highly recommend that you remove the door. This will make moving and turning the printer a lot easier and safer during the INDX conversion.
- Loosen and remove two M3x5rT screws securing the door panel in both hinges.
- ⚠ **Niezbędne jest podtrzymanie panelu drzwi podczas odkręcania śrub, aby zapobiec jego opadnięciu.**
- 📌 Zaczynaj odkręcać śruby, zaczynając od tych niżej.
- Ostrożnie wyciągnij panel drzwi z zawiasów.
- Place the door panel and the four screws in a **clean and safe area** to avoid any damage.
- 📌 Ensure that the shaft that is inside the hinge does not fall out. If the shaft falls out, insert it back in, or set it aside along with the hinge part. We will mount these back on at the end of the assembly.

## KROK 7 Accessing the electronics



- Po wewnętrznej stronie drukarki wykręć dwie śruby M3x4rT mocujące tylną pokrywę.
- Z tyłu drukarki przesunij środkową pokrywę w dół.  
🔧 Jeśli trudno jest ją przesunąć, użyj wkrętaka wsuniętego w otwór jako dźwigni.
- Upewnij się, że cztery zaczepy na górze pokrywy są odłączone od metalowej obudowy.
- Remove the cover from the printer.

## KROK 8 Accessing the buddy board

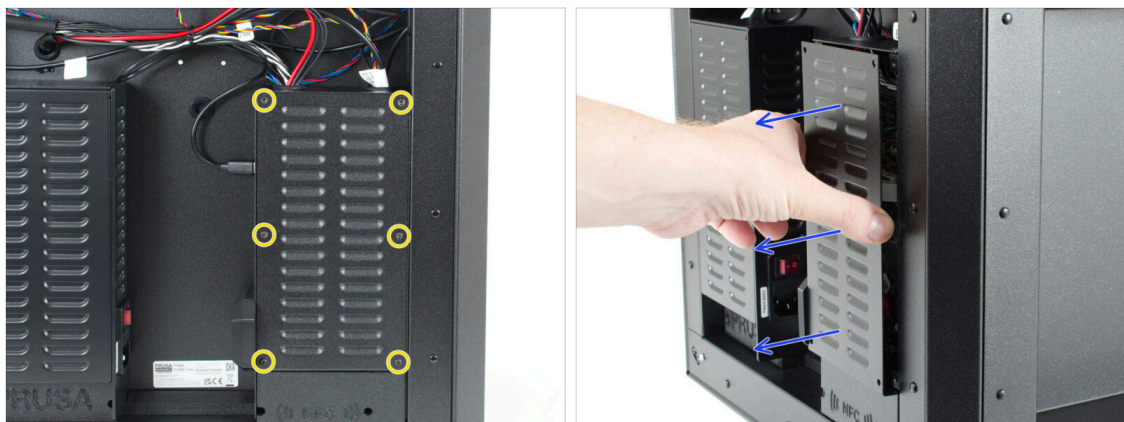

- Wykręć wszystkie sześć śrub M3x4rT mocujących pokrywę obudowy xBuddy.
- Wysuń pokrywę xBuddy z obudowy i wyjmij ją z drukarki.

## KROK 9 Unplugging the cable I.

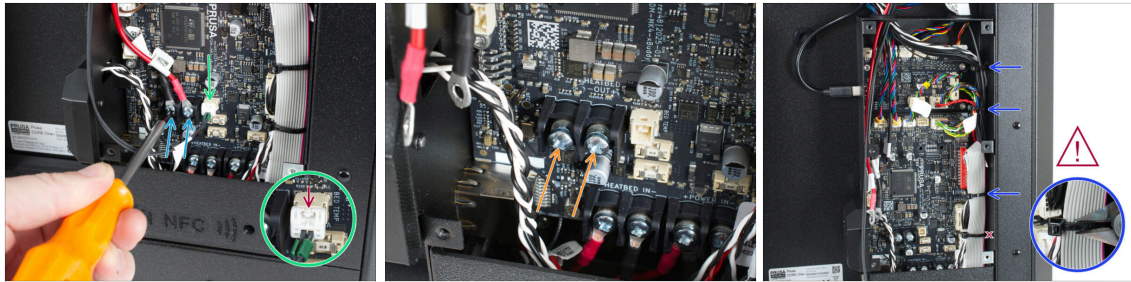

- ◆ Using a PH2 screwdriver, unscrew the two 6 32 screws and disconnect the heatbed power cables from the xBuddy.-32 screws and disconnect the heatbed power cables from the xBuddy.
  - ◆ Pro tip: After disconnecting the cables, loosely thread both screws back in by at least three turns so they are not lost.
  - ◆ Disconnect the heatbed thermistor cable from the xBuddy board.
    - ⚠ The cable connector has a safety latch. It is necessary to **press the latch before disconnecting** the cable.
- ◆ Carefully cut the zip ties along the right side of the xBuddy box. Do not cut the lower cable tie.
  - ⚠ **Avoid cutting any cables.**
  - ⓘ Cable ties can be cut using flush cutters, if available.

## KROK 10 Unplugging the cables II.

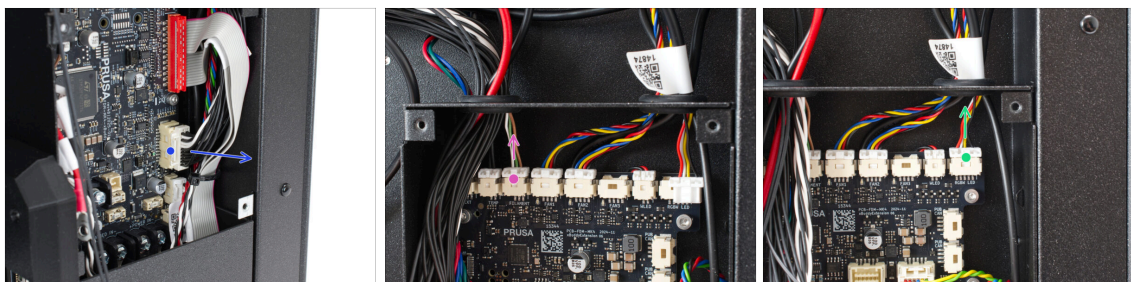

- ⚠ The cable connector has a safety latch. It is necessary to **press the latch before disconnecting** the cable.
- ◆ Disconnect the Nextruder main cable from the xBuddy board.
- ◆ Disconnect the side filament sensor from the xBuddy extension board.
- ◆ Disconnect the RGB LED cable from the xBuddy extension board.

## KROK 11 Removing the cables

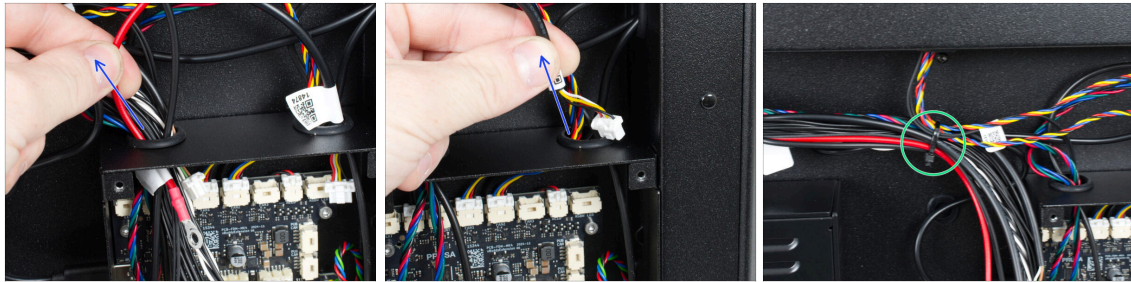

- ◆ Route the disconnected cables out of the xBuddy box through the corresponding openings at the top.
- ⚠ **Do not pull on the cables if you feel any resistance.**
- ⓘ The Nextruder main cable may pass through either the right or left opening, depending on when the printer was assembled.
- ◆ Be careful not to remove the grommets - but don't worry, they can be easily reinserted.
- ◆ Cut the zip ties securing the cable harness.
- ⚠ **Avoid cutting the cables.**

## KROK 12 Pushing the cables in



- ◆ Slide the upper grommet slightly out of the opening to prevent it from falling into the printer while routing the cables.
- ◆ Route the Nextruder main cable through the upper oval opening completely into the printer.
- ◆ Reinsert the grommet into the oval opening.
- ◆ Route the side filament sensor cable through the lower oval opening into the printer.

### KROK 13 Guiding the heatbed cables in

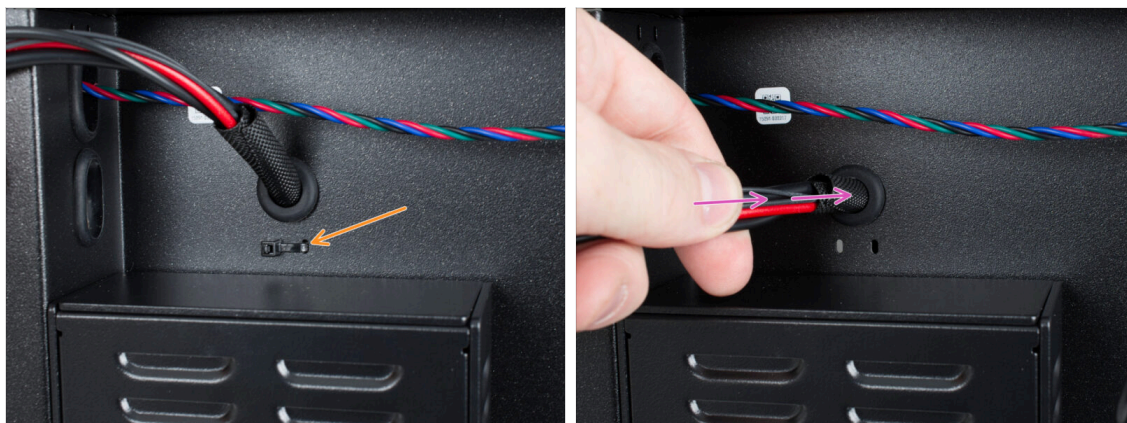

- ✦ Cut and remove the zip tie securing the heatbed cable bundle.
- ✦ Guide the heatbed cable bungle into the printer.
- Leave all loosened cables freely inside the printer. You will return to them later.

### KROK 14 Releasing the main cable



- Turn the printer so that its left side faces you (the side without the spool holder).
- ✦ Release the five cable straps.
- Focus on the area behind the Y-axis motor.
- Using a 2.5 mm Allen key, loosen the M3 screw securing the cable clip.
  - No need to remove the screws from the part. Let the Nextruder main cable hang freely together with the cable clip.

## KROK 15 Removing the LoveBoard cover



- Przejdźmy teraz do lewej strony Nextrudera.
- Wykręć kluczem imbusowym 2,5 mm dwie śruby M3x10 mocujące boczną pokrywę.
- Remove the cover.
- Unlock the Idler-swivel.
- Open the idler assembly fully.

## KROK 16 Disconnecting the Nextruder cables - left

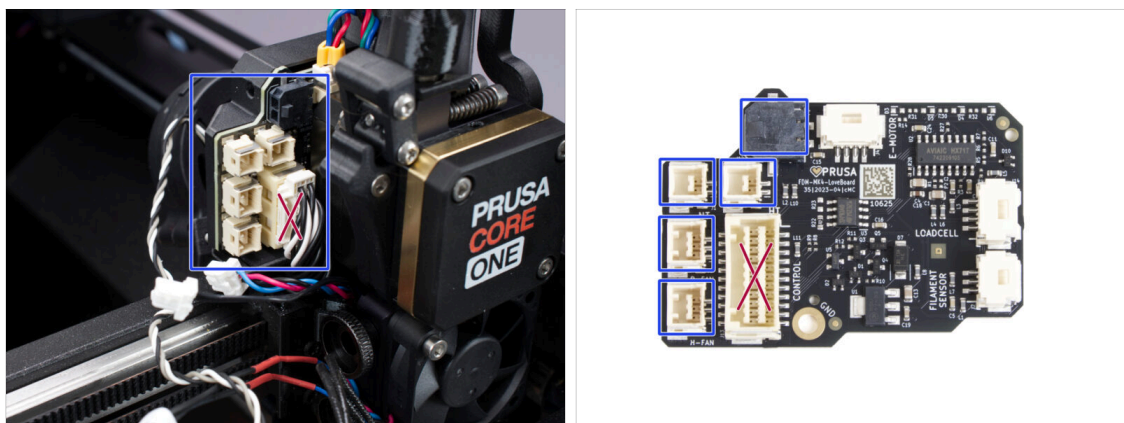

⚠ Każde złącze ma zatrzask zabezpieczający, który **należy koniecznie nacisnąć przed odłączeniem**. W przeciwnym razie może dojść do uszkodzenia złącza.

- Disconnect all cables on the left side of the LoveBoard.
- Do not disconnect the Nextruder main cable connector.

## KROK 17 Disconnecting the Nextruder cables - top

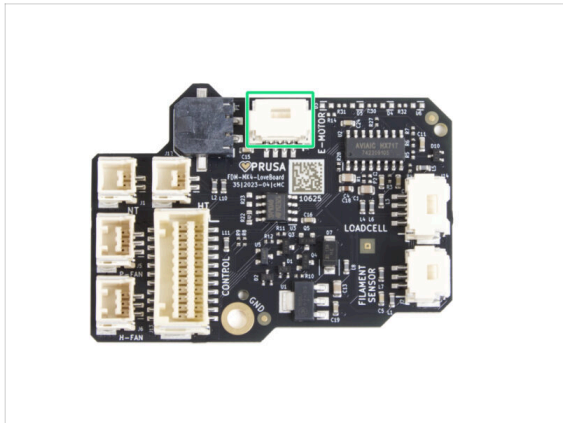
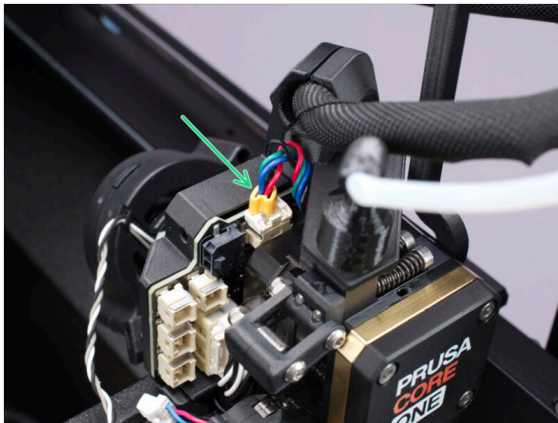

⚠ Each connector has a safety latch. It is necessary to **press the latch before disconnecting**. Otherwise, the connector may get damaged.

- 🟢 Disconnect the extruder motor cable.

## KROK 18 Disconnecting the Nextruder cables - right

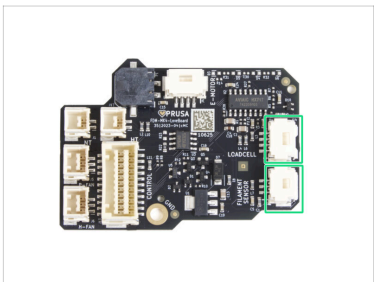
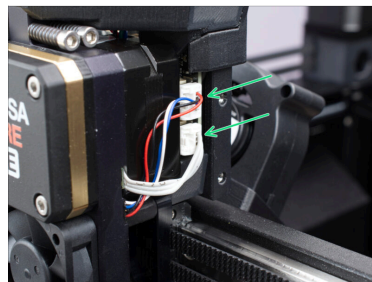
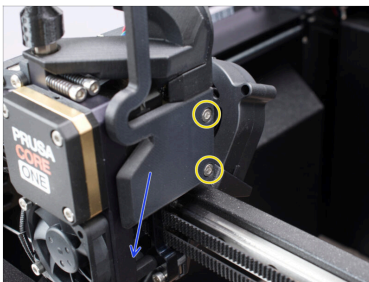

- 🟡 Using the Allen key, remove two M3x6 screws securing the right cover on the Nextruder.

- 🟠 Remove the cover.

⚠ Each connector has a safety latch. It is necessary to **press the latch before disconnecting**. Otherwise, the connector may get damaged.

- 🟢 Disconnect both cables from the right side of the LoveBoard.

## KROK 19 Odłączenie rurek PTFE



- ◆ Slide the bowden-bend over the fitting in the Nextruder.
- ◆ Press the black collet in the fitting down, preferably using two fingers.
- ◆ Pull the PTFE tube out of the fitting.
- ◆ Remove the bowden-bend from the PTFE tube.

## KROK 20 Removing the Nextruder fitting

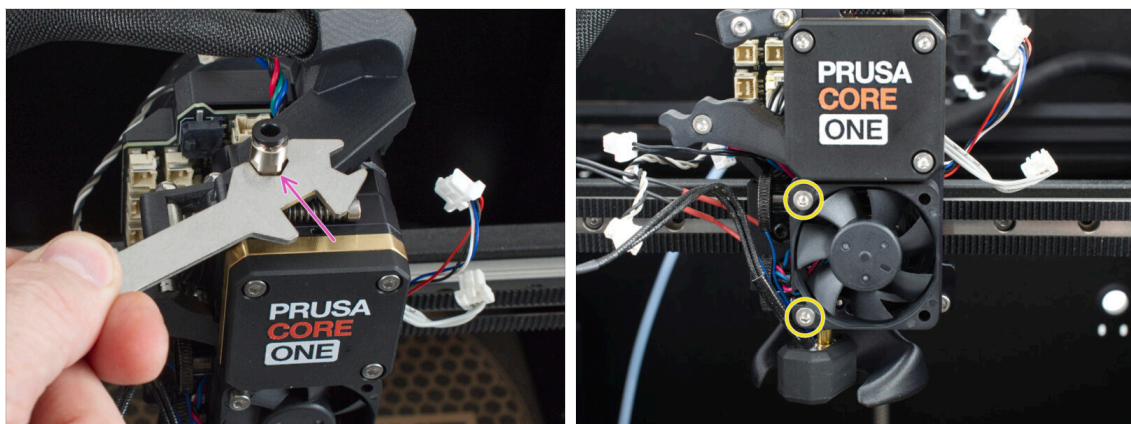

- ◆ Using the 8mm cutout on the Universal wrench, remove the M5-4 fitting.
- ◆ Using the Allen key, remove two M3x18 screws securing the heatsink fan.
- 📌 After being released, the heatsink fan will likely hang on the cable. Leave it as it is for now.

## KROK 21 Removing the Nextrunder

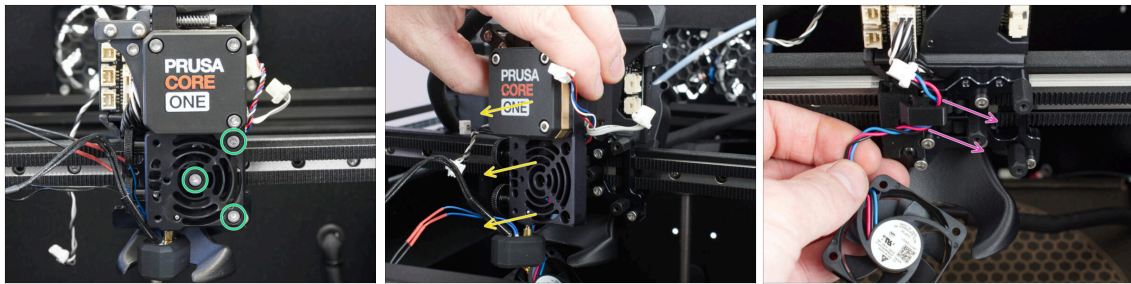

- ◆ Remove three M3x10 screws securing the Nextrunder assembly to the X-axis.
  - ⚠ **CAUTION:** While loosening the last screw, **hold the Nextrunder to prevent it from falling** and damaging the printer.
- ◆ Remove the Nextrunder assembly from the printer.
- ◆ Unhook the heatsink fan cable from the cable hook and remove the fan from the printer.

## KROK 22 Demontaż wentylatora wydruku

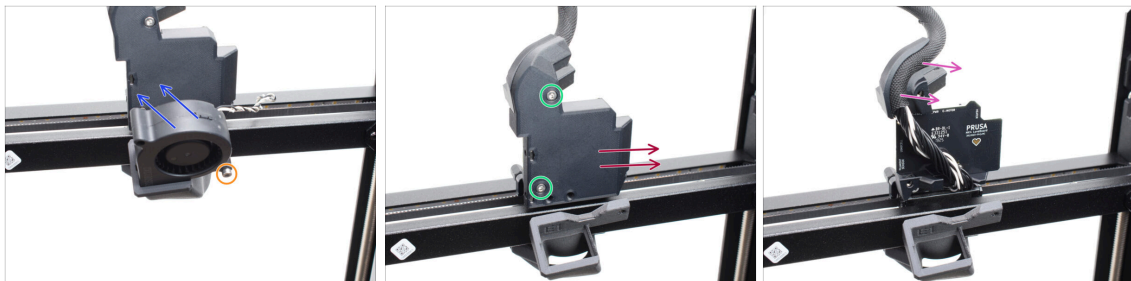

- ◆ Focus on the rear X-axis assembly.
- ◆ On the back of the print head, remove the M3x25 screw holding the print fan.
- ◆ Wyciągnij wentylator wydruku, pociągając go do góry.
- 📌 Set the print fan. It will be needed later for the new toolhead.
- ◆ Remove the two M3x10 screws holding the cover on the back of the print head.
- ◆ Remove the cover.
- ◆ Dislodge the extruder main cable from the dedicated groove.

## KROK 23 Removing the LoveBoard



- ◆ Release and remove the M3x8rT screw securing the LoveBoard.
- ◆ Remove the LoveBoard with the Nextruder main cable completely from the printer.
- ◆ Loosen two M3x10 screws in the Loveboard-holder.
- ◆ Remove the Loveboard-holder from the printer.

## KROK 24 Removing the fan shroud

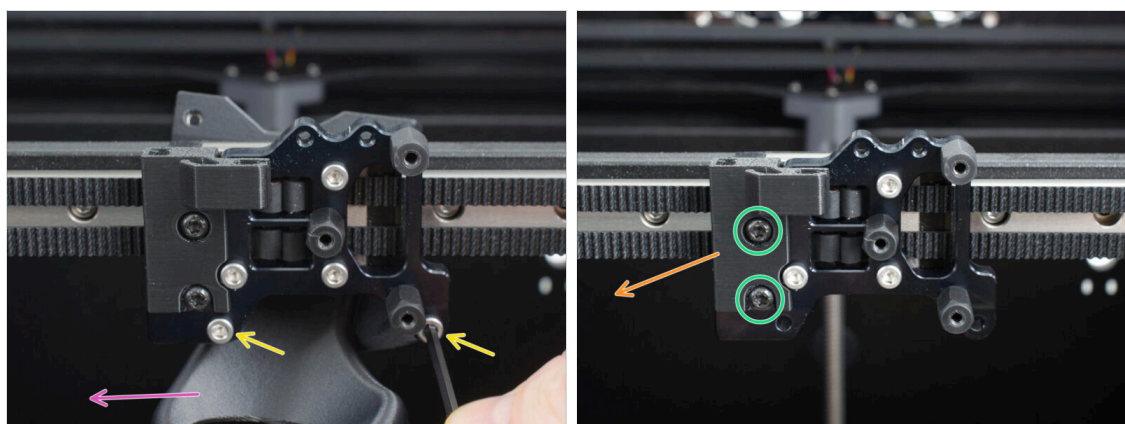

- ◆ Release and remove two M3x10 screws securing the Fan-shroud to the Nextruder holder.
- ◆ Remove the Fan-shroud from the printer.
- ◆ Using the T10 key, remove two M3x4rT screws mounting the Cable-clip.
- ◆ Remove the Cable-clip from the printer.

## KROK 25 Removing the side handle

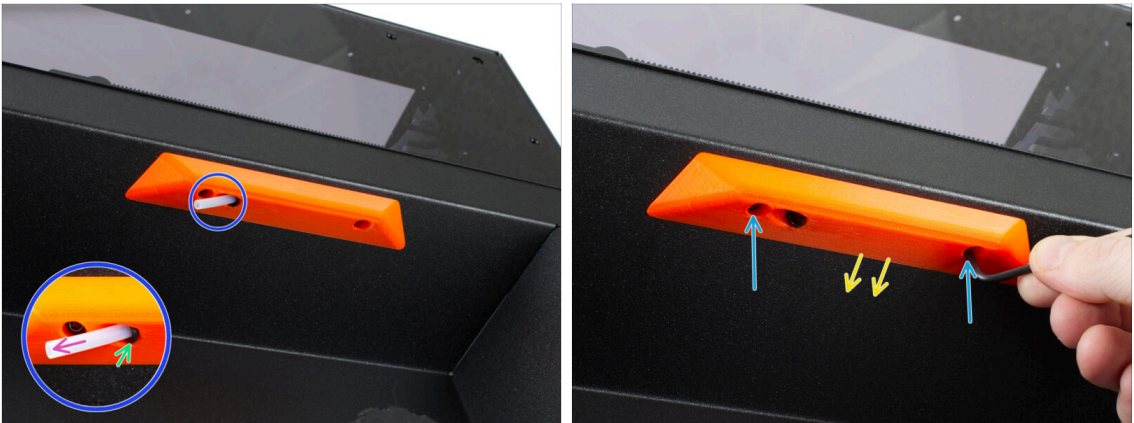

- ◆ Take a close look at the input PTFE tube in the handle on the right side panel.
- ◆ Push in the collete in the handle.
- ◆ Wyciągnij rurkę PTFE.
- ◆ Using the T10 screwdriver release two M3x8rT screws securing the handle and the filament sensor.
- ◆ Remove the handle from the printer.

## KROK 26 Removing the side filament sensor



- ◆ Shift your focus back inside the printer.
- ◆ Carefully cut and remove the zip tie near the PTFE tube.
  - ◆ This releases the side filament sensor cable from the underside of the CoreXY frame.
- ◆ Grasp the released side filament sensor on the inner side of the right side panel and remove it from the printer.

## KROK 27 Removing the spoolholder



Using the T10 screwdriver, remove the four M3x8rT screws inside the printer securing the spoolholder.

**⚠ Be careful not to scratch the heated bed.**

While loosening the last screw, hold the spool holder in your hand and remove it from the printer.

**⚠ Place the protective cardboard box back onto the heated bed.**

## KROK 28 Parts recap I.



**⚠ Keep the following parts for the next steps.**

**i** Any parts not listed can be set aside.

- ◆** From the fasteners, we recommend **keeping all removed screws.**
- ◆** Sheet metal back cover (1x)
- ◆** xBuddy box cover (1x)
- ◆** Print fan (1x)
- ◆** Print sheet (1x)
- ◆** Cable tie (2x)

## KROK 29 Parts recap II.



- ◆ Door panel assembly (1x)

## KROK 30 Haribo time!



- ⚠ Check the number in the circle carefully. It shows exactly how many gummy bears to eat in this step. **Do not eat more.**

- ◆ Zjedz sześć żelków.

---

### KROK 31 Final step



- ◆ The printer is now ready for the INDX upgrade.
- ◆ Proceed to the next chapter: **3. Upgrading the printer.**

### 3. Upgrade osi Z



## KROK 1 Narzędzia niezbędne w tym rozdziale

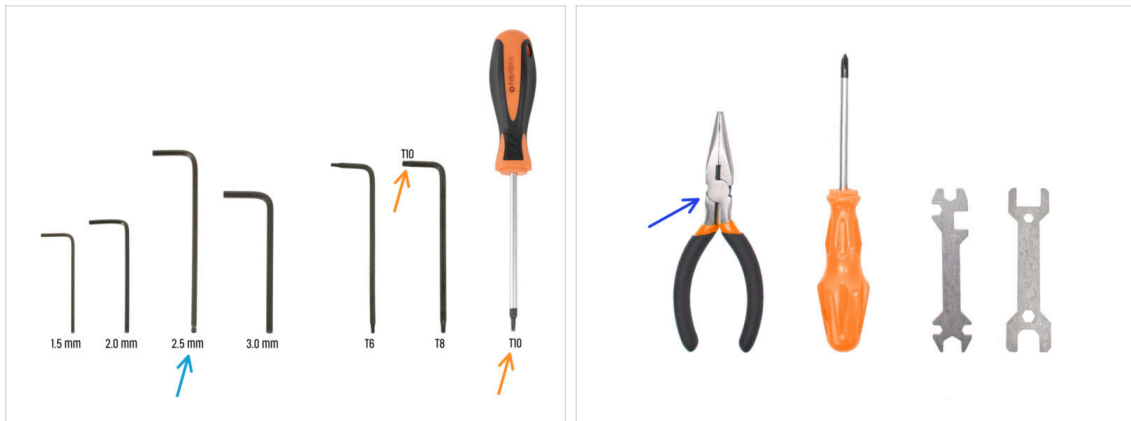

- Do tego rozdziału przygotuj:
- Klucz imbusowy 2,5 mm
- T10 key / screwdriver
- Needle-nose pliers or flush cutters for cutting zip ties

## KROK 2 Optional: Installing the Buddy3D Camera USB-C cable



- i** This step applies only if you **purchased the Buddy3D Camera** and plan to install it.
- Now is the right time to install the USB-C cable included with the Buddy3D Camera.
- To install the cable, follow the dedicated **Buddy3D Camera for CORE One Installation** guide.
- Do not connect or mount the camera itself** at this stage. This will be done at the end of the assembly.

### KROK 3 Demontaż pokrywy przewodów stołu grzewczego

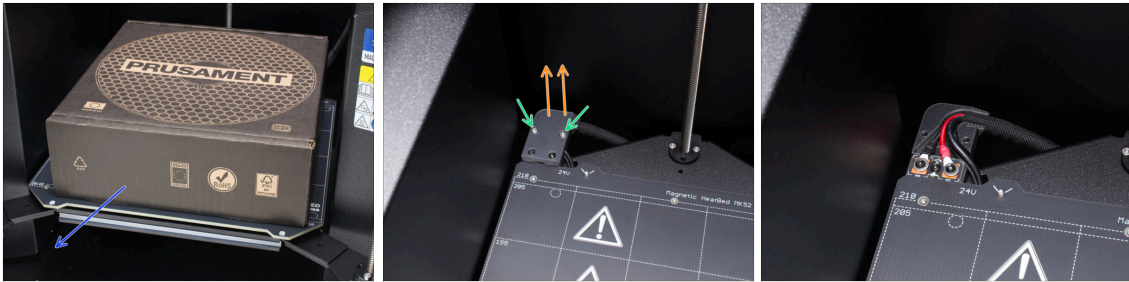

- ◆ Temporarily remove the protective cardboard box from the heatbed.
- ◆ Focus on the heatbed cable area at the rear left.
- ◆ Unscrew two M3x10 screws securing the CORE-One-bed-cable-cover-top.
- ◆ Remove the CORE-One-bed-cable-cover-top.
- ⓘ You will no longer need the CORE-One-bed-cable-cover-top. We recommend removing it to avoid confusion with the new part.

### KROK 4 Releasing the heatbed



- ◆ Pull the heatbed cable bundle out from underneath the heatbed.
- ⚠ Be careful **not to snag the cables**. If you feel resistance, **stop pulling immediately**.
- ◆ Remove the textile sleeve from the entire length of the cable bundle.
- ⓘ Set the sleeve aside, you will need this part again later.
- ◆ Release and remove eight M3x4bT screws securing the heatbed.
- ◆ Release and remove the M3x12bT screw in the middle.

## KROK 5 Removing the heatbed

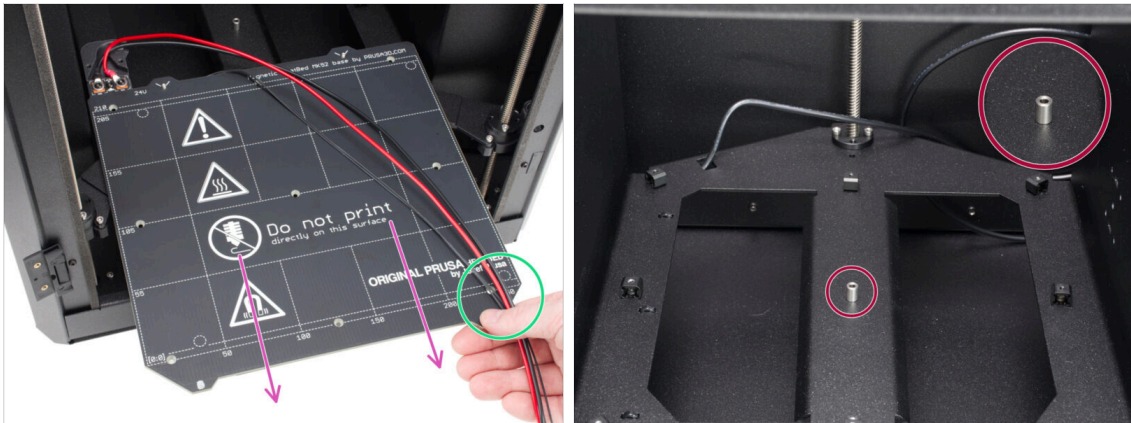

- Carefully remove the heatbed out of the printer.
  - Remove it together with the cables **leading from the heatbed**.
  - **Set the heatbed aside in a safe place**, it will be needed again later.
- ⚠ After removing the heatbed, a **spacer remains loose on the Z-carriage**. **Keep it in a safe place for later use**.

## KROK 6 Removing the bed spacer

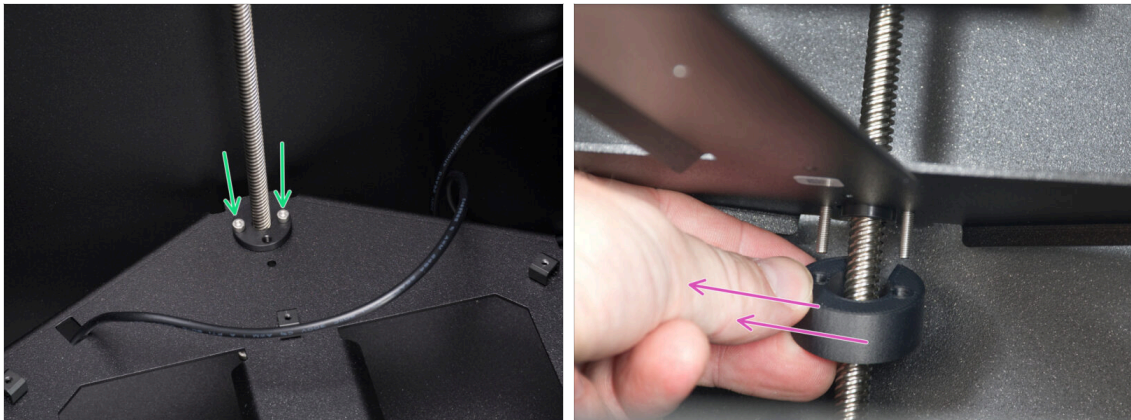

- Loosen two M3x18 screw securing the trapezoidal nut and the CORE-One-bed-spacer-rear (on the underside).
  - While loosening the screws, hold the CORE-One-bed-spacer-rear in place and remove it once they are loose.
- 📌 **Leave the screws in the trapezoidal nut.**
- ⓘ Discard the CORE-One-bed-spacer-rear to avoid confusion with the new part. You will no longer need this part.

## KROK 7 Tulejki dystansowe: przygotowanie części



- Do kolejnych etapów przygotuj:
- INDX-C1-bed-spacer-rear (1x) found in the Heatbed bag
- INDX-C1-bed-spacer-front (2x) found in the Heatbed bag
- M3xnN nut (2x) found in the Fasteners 1/2 bag
- M3x18 screw (4x) found in the Fasteners 1/2 bag

## KROK 8 Assembling the INDX-bed-spacer-rear



- Insert two M3nN nuts into the Bed-spacer-rear and **push them in as far as possible**.
- Insert the nuts with the nylon insert (blue plastic ring) **facing up**.

## KROK 9 Mounting the INDX-bed-spacer-rear

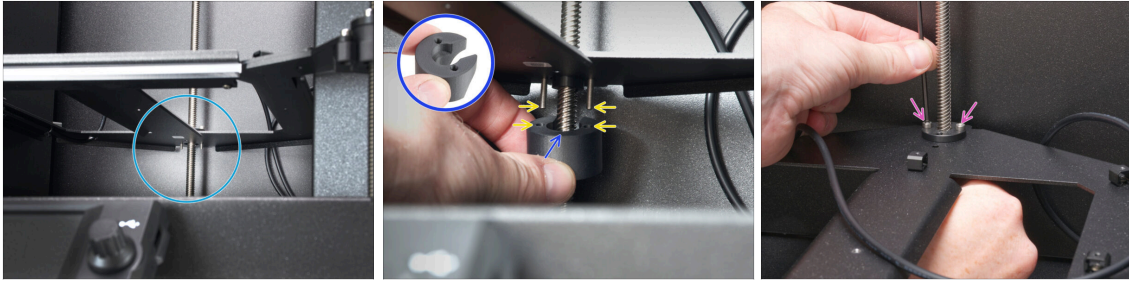

- Focus on the rear underside of the heatbed.
- Hold the Bed-spacer-rear **in the same orientation as shown** and fit it **around** the rear Z-axis threaded rod.
- Align the holes in the bed spacer with the M3x18 screws that you kept in the trapezoidal nut.
- Secure the part by tightening the two M3x18 screws.

## KROK 10 Inserting the spacer - left



- Focus on the front left Z-axis.
- Remove the two M3x10 screws securing the Z-carriage to the Z-axis.  
**⚠ Do not remove the screws from the trapezoidal nut.**
- Gently lift the Z-carriage so that a gap of approximately 8 mm (0.3 inches) is created between it and the bed mount. mm (0.3 inches) is created between it and the bed mount.
- Insert the Bed-spacer-front into the gap.
- Position the part so it fits around the bed mount, then align the holes.

## KROK 11 Securing the bed spacer - left



- i** Make sure the two M3N nuts inserted from below do not fall out of the bed mount.
- Secure the spacer with two M3x18 screws.
  - Tighten the inner screw first.
  - Then tighten the outer screw.

## KROK 12 Inserting the spacer - right

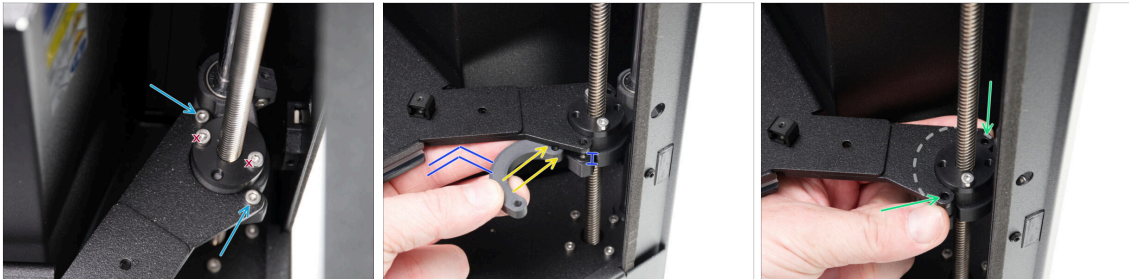

- Focus on the front right Z-axis.
- Remove the two M3x10 screws securing the Z-carriage to the Z-axis.
  - !** Do not remove the screws from the trapezoidal nut.
- Gently lift the Z-carriage so that a gap of approximately 8 mm (0.3 inches) is created between it and the bed mount.
- Insert the Bed-spacer-front into the gap.
- Position the part so it fits around the bed mount, then align the holes.

## KROK 13 Securing the bed spacer - right



- i** Note that there are two M3nN nuts inserted into the bed mount from below. Ensure that these do not fall out.
- Secure the spacer with two M3x18 screws.
  - Tighten the inner screw first.
  - Then tighten the outer screw.

## KROK 14 Offset sensor: parts preparation



- **For following steps, prepare:**
- INDX-C1-offset-sensor-holder (1x) *found in the Heatbed bag*
- INDX OffsetSensor (1x) *found in the Filament Sensors box*
- M3x8rT screw (1x)
- Śruba M3x10 (1x) *wykręcona wcześniej*
- Offset sensor cable (1x) *found in the Cables bag*
- Zip tie (4x)

## KROK 15 Mounting the INDX OffsetSensor

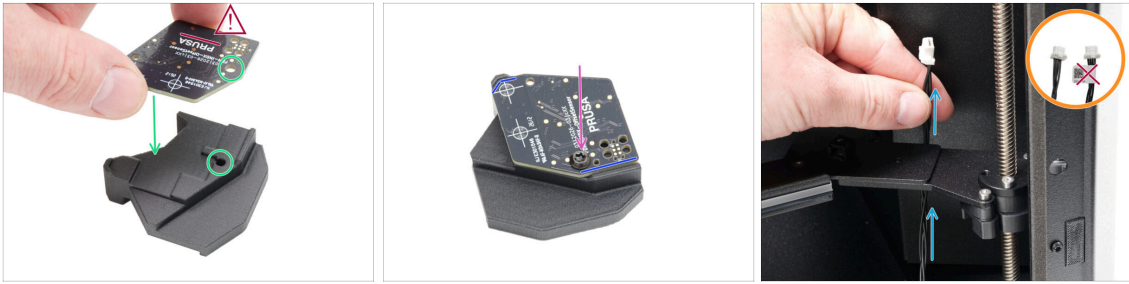

- i** The printed parts shown may differ slightly from the parts included in your package.
- Mount the offset sensor onto the Offset-sensor-holder.
    - Align the screw holes with each other.
    - !** Make sure the **PRUSA** logo is facing up.
    - Ensure that the offset sensor is correctly positioned.
    - Secure the offset sensor in place with the M3x8rT screw.
- Do not overtighten the screw** to avoid damaging the electronics.
- Lead the offset sensor cable between the Z-carriage and the side panel of the printer.
    - Take the end of the cable **without a label**.

## KROK 16 Connecting the offset sensor cable

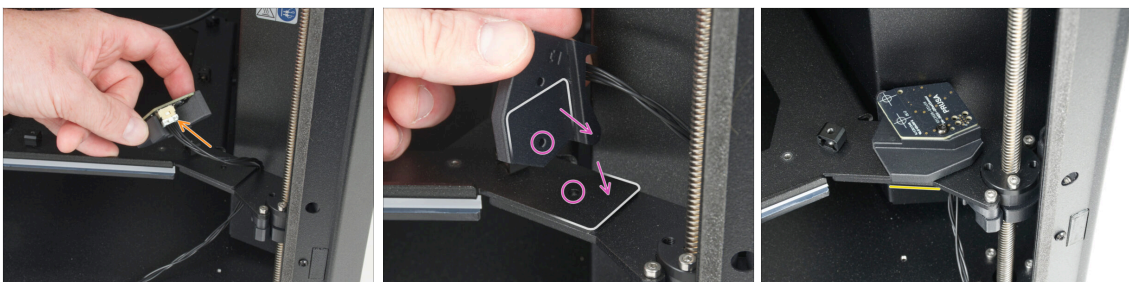

- Plug the offset sensor cable into the offset sensor board connector.
- On the underside of the Offset-sensor-holder, locate the pocket shaped for the Z-carriage.
  - Place the Offset-sensor-holder onto the Z-carriage so the shapes fit together and the screw holes align.
- Check the correct alignment. It must match the photo.

## KROK 17 Securing the offset sensor assembly

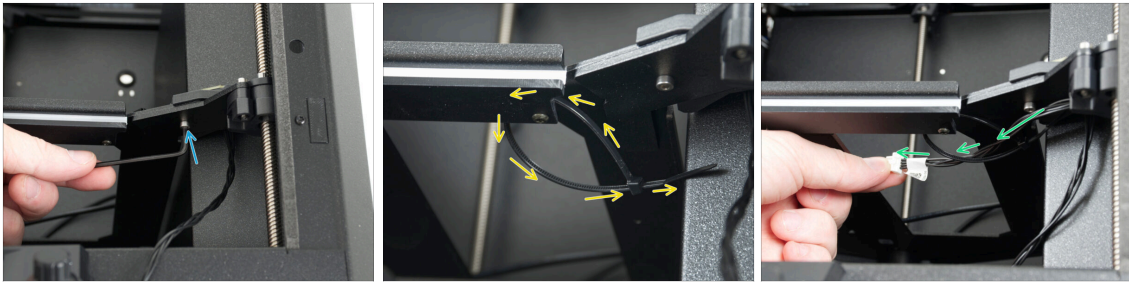

- ◆ Secure the offset sensor assembly to the Z-carriage from the underside using the M3x10 screw.
- ◆ Loop a zip tie around the screw in the LED panel assembly and secure it, **but do not tighten it yet.**
- ◆ Lead the offset sensor cable through the zip tie.

## KROK 18 Guiding the offset sensor cable

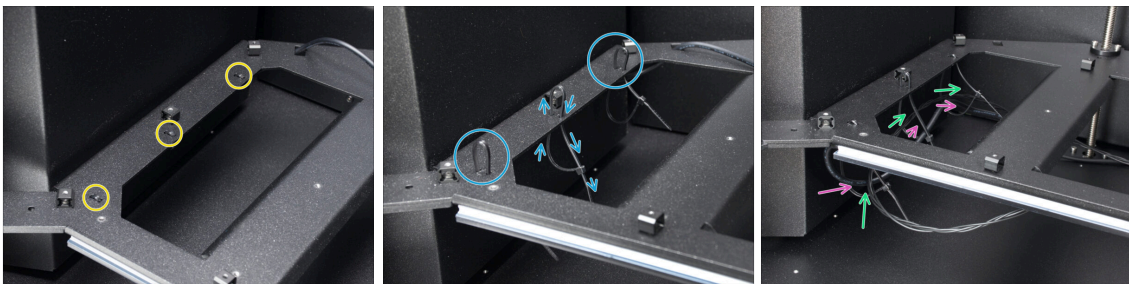

- ◆ On the left side of the Z-carriage, use side cutters to remove the three highlighted zip ties.
  - ⓘ Cutting the cable ties will release the RGB LED cable, which is secured by them.
- ◆ Thread three cable ties through the Z-carriage and connect their heads on the underside. Do not tighten them yet.
- ◆ Guide the offset sensor cable through the three zip ties.
- ◆ Guide the RGB LED cable through the three zip ties.

## KROK 19 Securing the offset sensor cable

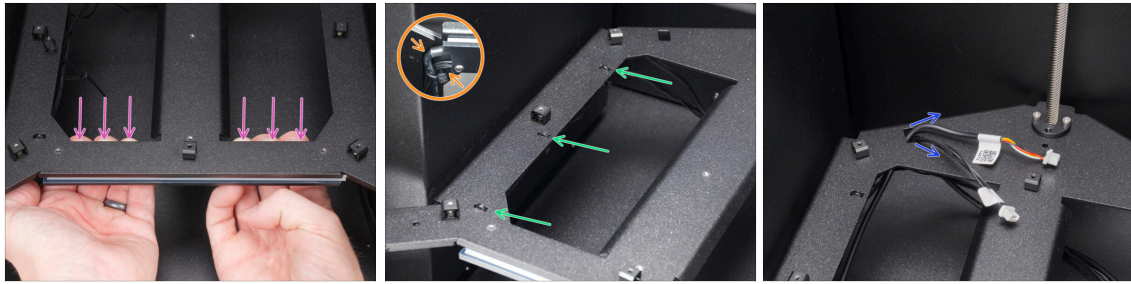

- ◆ Tuck the offset sensor cable in between the Z-carriage and the LED panel.
- ◆ Tighten all three cable ties and cut off the excess ends.
  - ◆ The cables before the first cable tie **must not be sharply bent**; leave a slight slack.
  - ◆ Make sure the cables are properly tensioned and **not sagging** along their entire length.
- ◆ Route the offset sensor and RGB LED cables upward through the rectangular cutout in the Z-carriage.

## KROK 20 Removing the Bed-cable-cover-bottom

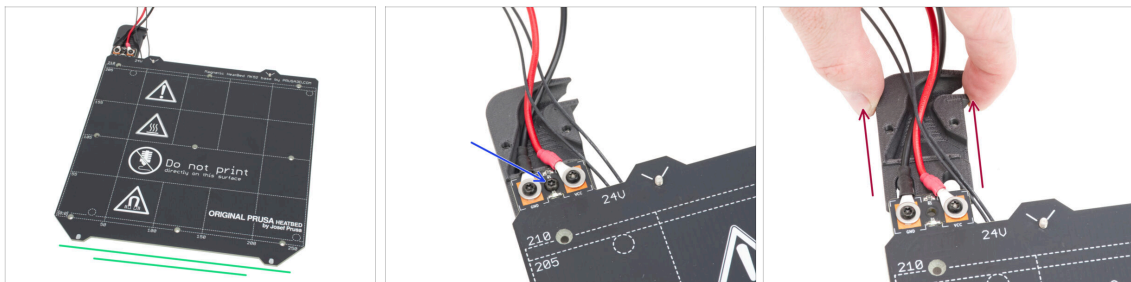

- ◆ Prepare the heatbed assembly.
- ◆ Using the Torx key, remove the M3x10rT screw that keeps the Bed-cable-cover-bottom attached.
- ◆ Remove the Bed-cable-cover-bottom.

## KROK 21 Heatbed cable covers: parts preparation

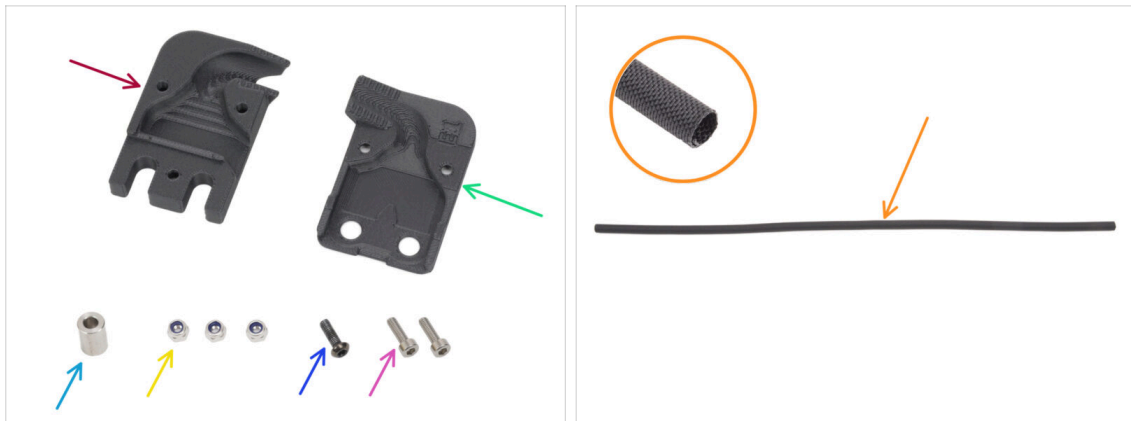

### Do kolejnych etapów przygotuj:

- INDX-C1-bed-cable-cover-bottom (1x) *found in the Heatbed bag*
- INDX-C1-bed-cable-cover-top (1x) *found in the Heatbed bag*
- Heatbed spacer 6x3.1x8 mm (1x) *removed earlier*
- M3nN nut (3x) *found in the Fasteners 1/2 bag*
- M3x10rT (1x) *removed earlier*
- M3x10 screw (2x) *removed earlier*
- Textile sleeve 520 x 8 mm (1x) *remove earlier*

## KROK 22 Heatbed cable covers: parts preparation II

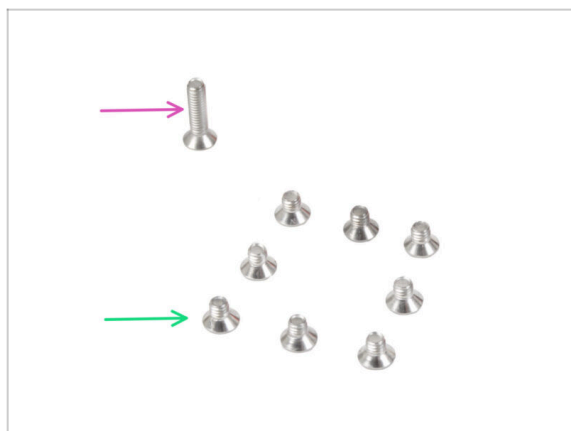

### Do kolejnych etapów przygotuj:

- M3x12bT screw (1x) *removed earlier*
- M3x4bT screw (8x) *removed earlier*

## KROK 23 Assembling the Bed-cable-cover-bottom

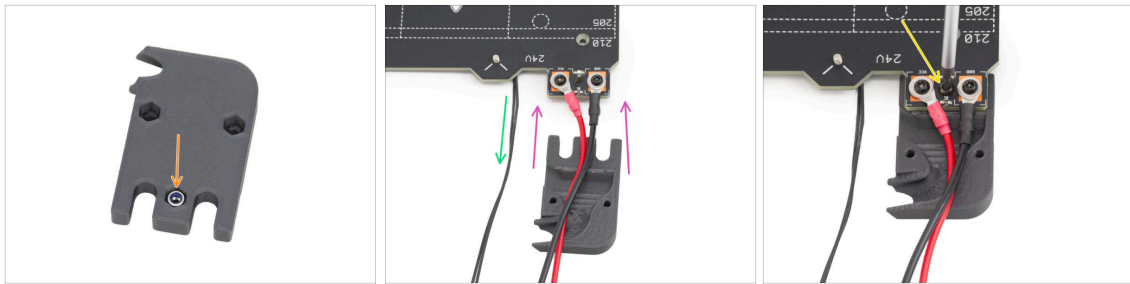

- 🟠 Insert the M3nN nut into the bottom hole in the Bed-cable-cover-bottom.
- 🟢 Route the heatbed thermistor cable outside the cover.
- 🟣 Insert the Bed-cable-cover-bottom under the heatbed power cables and slide the cover beneath the heatbed.
- 📄 **i** The M3nN nut may fall out during installation. You can hold it in place from the bottom with your finger.
- 🟡 Secure the Bed-cable-cover-bottom in place with the previously removed M3x10rT screw.

## KROK 24 Inserting the heatbed

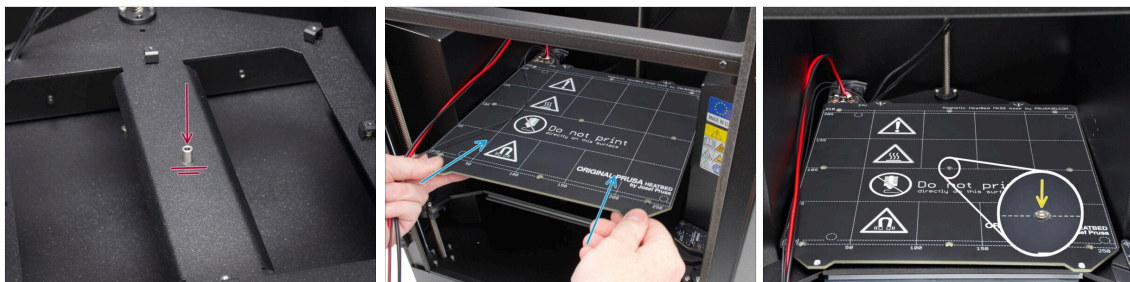

- 🟣 Place the heatbed spacer directly over the threaded hole in the center of the Z-carriage.
- 🟢 Carefully insert the heatbed assembly back into the printer.
  - ⬛ Ensure that the spacer in the middle stays in place.
- 🟡 Secure the heatbed in place with the M3x12bT screw that you set aside when initially removing the heatbed. **Do not fully tighten the screw yet.**

## KROK 25 Securing the heatbed

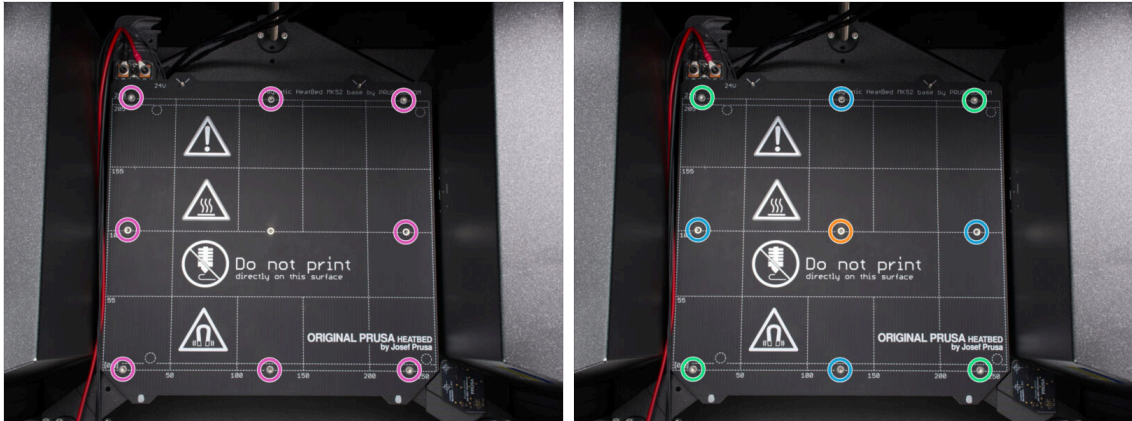

- Insert the M3x4bT screws into the remaining holes in the heatbed. Do not fully tighten the screws yet.

**! IMPORTANT:** The heatbed must be tightened in a specific order. Repeat the sequence multiple times, ensuring the final tightening after at least two rounds.

- After all screws are in place, tighten them in the following sequence:

- Center screw
- Pierwsze cztery śruby (krawędzie)
- Ostatnie cztery śruby (narożniki)

**🔧** Dokręć śruby mocno, ale z wyczuciem.

## KROK 26 Owiniecie przewodów podgrzewanego stołu

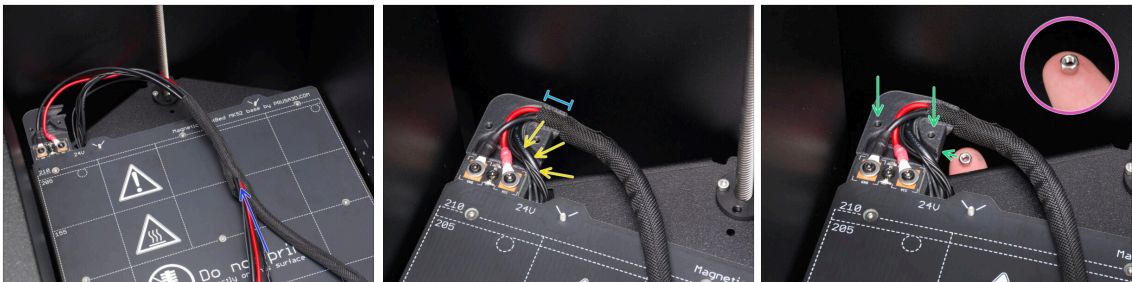

- Wrap the textile sleeve around the heatbed, RGB LED, and offset sensor cables.
- Route the RGB LED and offset sensor cables into the Heatbed-cable-cover-bottom through the side channel.
- Slide the textile sleeve at least 1 cm (0.39 in) into the cable channel.
- Place the M3nN nut on your finger with the nylon insert (blue plastic ring) facing down.
- From below**, align it with the screw holes shown in the picture.
- Then **press the nut into the Bed-cable-cover-bottom** from underneath until it is fully seated.

## KROK 27 Montaż pokrywy przewodów stołu grzewczego

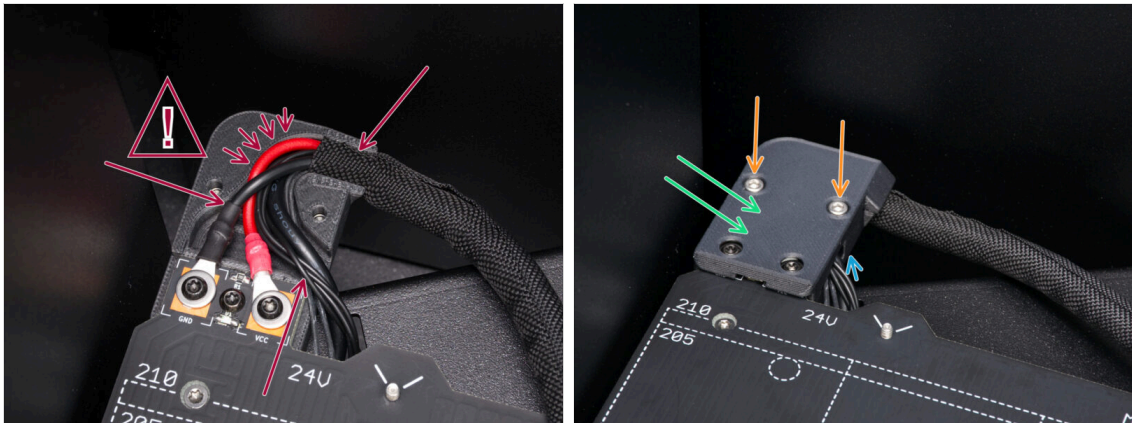

- ⚠ Before closing the cover, make sure **no wires are sticking out to prevent them from being pinched** by the top cover.
- 🟢 Place the Bed-cable-cover-top over the heatbed cables and align it.
- 🟠 Secure the Bed-cable-cover-top in place with the M3x10 screw.
  - 🟡 While tightening, **hold the M3nN nuts** in the lower part to prevent them from falling out.

## KROK 28 Guiding the heatbed cable bundle I.

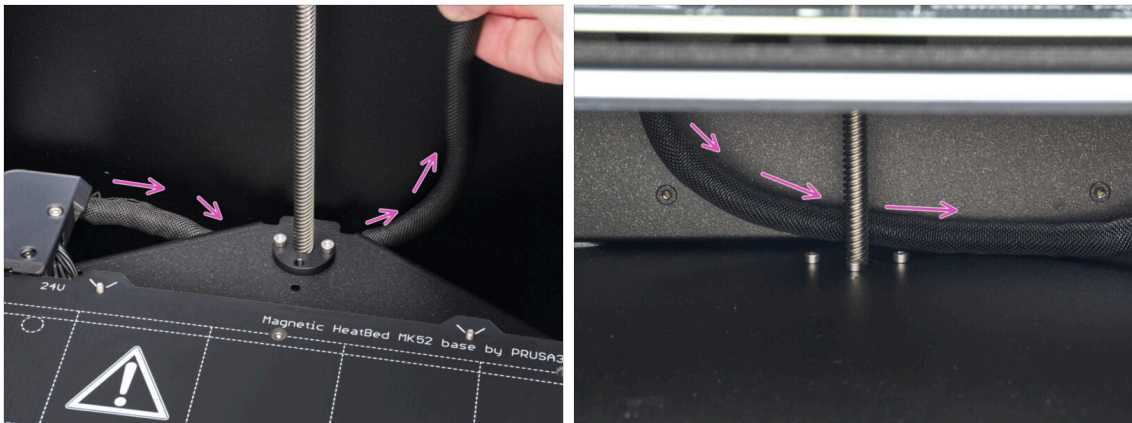

- 🟣 Lead the heatbed cables under the heatbed and **behind the Z-axis threaded rod**.

## KROK 29 Guiding the heatbed cable bundle II.



- Route the cables through the rear panel one by one in the following order:
  - 1. Offset sensor cable
  - 2. LED RGB cable
  - 3. Heatbed thermistor cable
  - Finally, route the heatbed power cables (black and red).
- Push the heatbed cables and the textile sleeve through the grommet hole.
  - No more than 1 cm (0.39 in) of the textile sleeve should protrude from the back side.

## KROK 30 Owinięcie przewodów owijką tekstylną

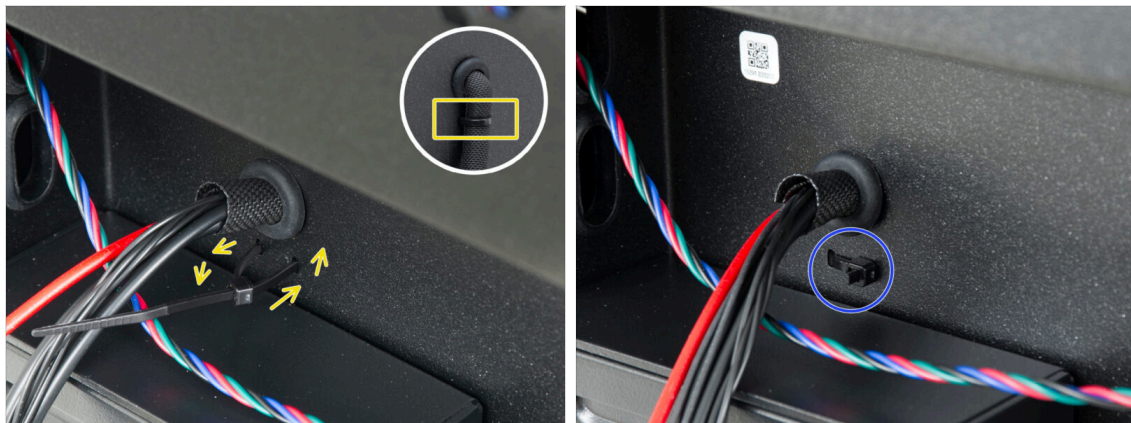

- Przełóż opaskę zaciskową przez dwa otwory pod przewodami stołu grzewczego i zrób pętlę wokół wiązki (z owijką tekstylną) od wewnątrz.
- Mocno zaciśnij opaskę zaciskową i odetnij jej nadmiar.

## KROK 31 Removing the Bed-stop-rear

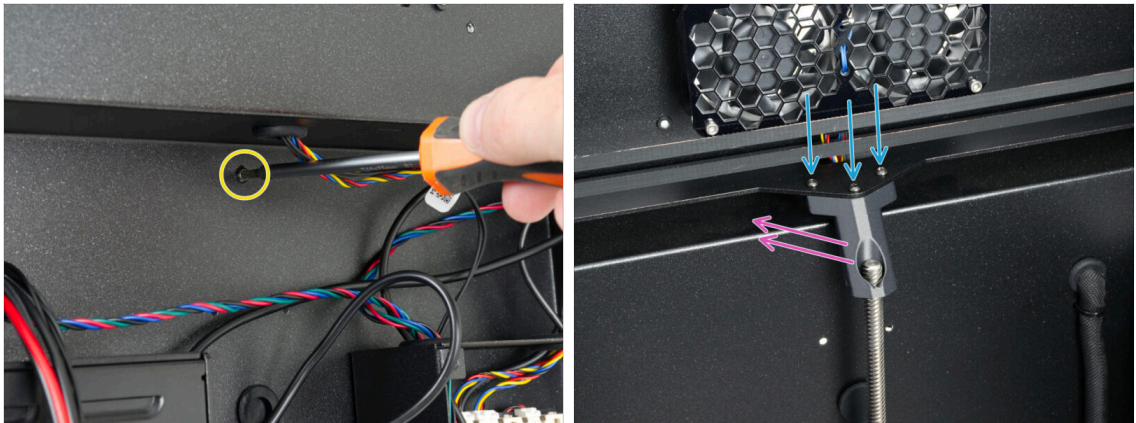

- Use a Torx key to remove the M3x8rT screw on the rear side of the printer.
- Remove the three M3x8rT screws.
- Remove the Bed-stop-rear.

## KROK 32 INDX-C1-Bed-stop-rear: parts preparation

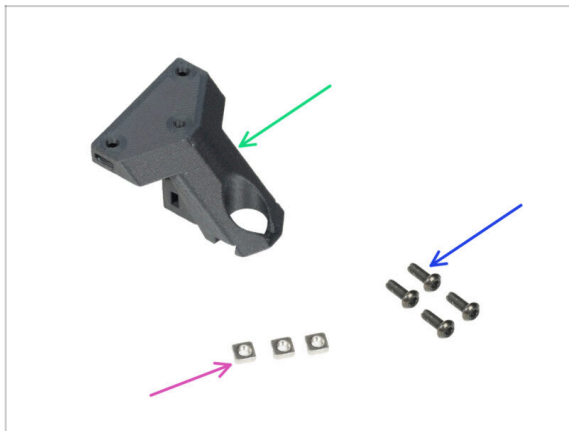

- Do kolejnych etapów przygotuj:
- INDX-C1-bed-stop-rear (1x)
- M3x8rT screw (4x) *removed earlier*
- M3nS nut (3x) *found in the fasteners 2/2 bag*

### KROK 33 Assembling the Bed-stop-rear

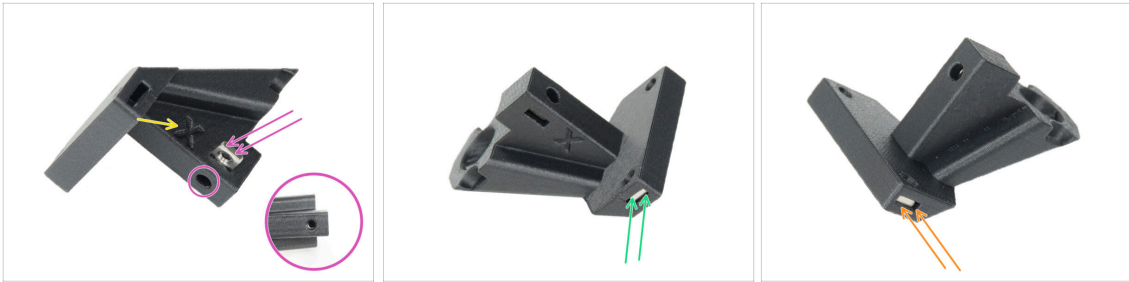

- The new Bed-stop-rear is labeled with an X.
- Insert the M3nS nut into the Bed-stop-rear and push it fully down.
  - Always check through the screw hole that the nut is properly aligned.
- From the same side, insert the second M3nS nut all the way into the part.
- From the opposite side, insert the third M3nS nut into the part.

### KROK 34 Installing the new Bed-stop-rear



- Place the Bed-stop-rear onto the rear Z motor threaded rod and rest it against the edge of the rear panel.
- Mount the Bed-stop-rear onto the Z-Axis threaded rod and secure it in place with three M3x8rT screws.
  - ⓘ The middle screw threads into the plastic, not into a nut. Expect slight resistance while tightening.

## KROK 35 Securing the Bed-stop-rear

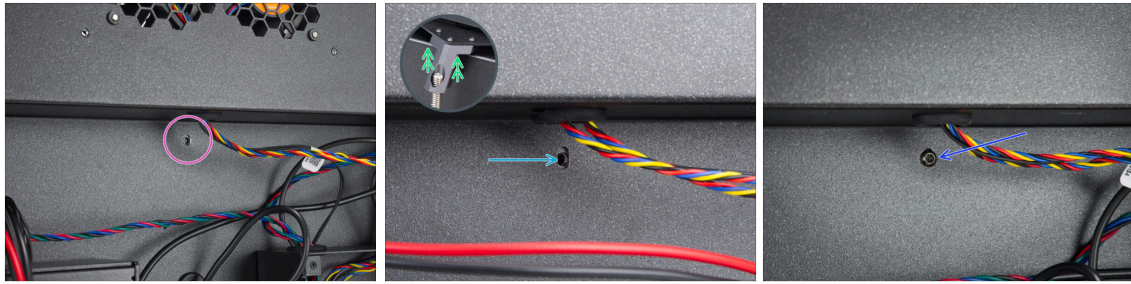

- Move to the back of the printer.
- Locate the oval screw hole under the cooling fans.
- The oval hole must be flush with the hole in the Bed-stop part on the opposite side.
- Aby to skompensować, nieznacznie podnieś tylną część zestawu CoreXY - zaledwie o kilka milimetrów.
- After aligning the holes, secure them with the M3x8rT screw.

## KROK 36 Connecting the RGB LED + offset sensor cables

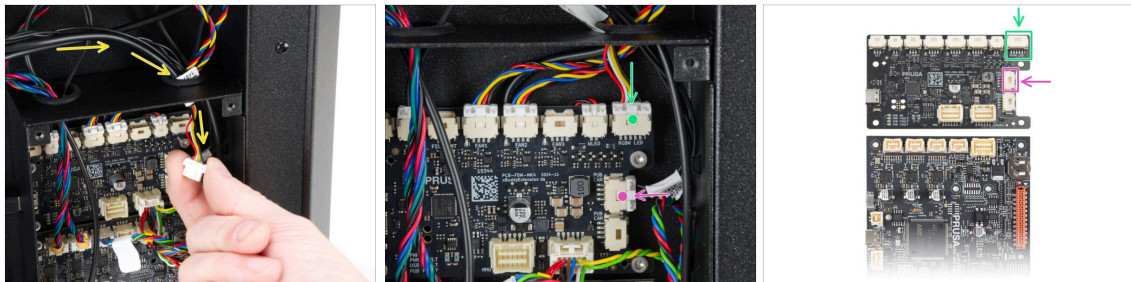

- Route the RGB LED cable and the offset sensor cable through the upper right opening in the xBuddy box.
- Plug the **RGB LED connector** into the **rightmost RGBW LED slot** on the xBuddy Extension board.
- Plug the **offset sensor cable** into the **upper right PUB CAN slot** on the xBuddy Extension board.

## KROK 37 Podłączenie przewodów stołu grzewczego

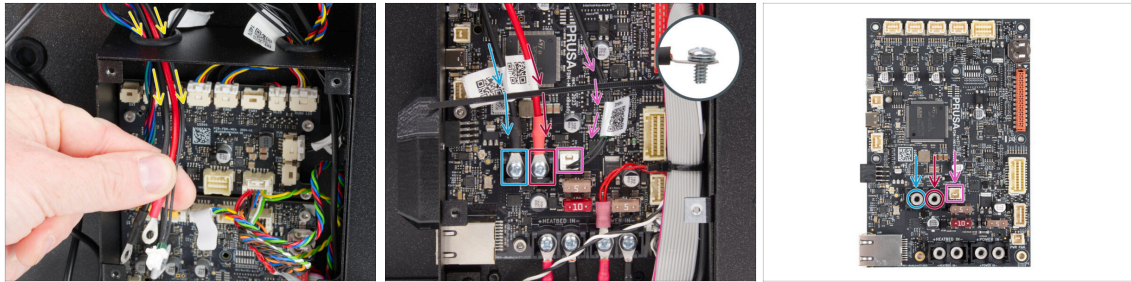

- Route the heatbed power cables and the heatbed thermistor cable through the **left opening** at the top of the xBuddy box.
- Using the 6-32 terminal screw connect the **black** power cable to the **left** terminal slot on the xBuddy board. Tighten firmly.
- Using the 6-32 terminal screw to connect the **red** power cable to the **right** terminal slot. Tighten firmly.
- Plug the heatbed thermistor connector to the slot next to the power terminals.

## KROK 38 Haribo time

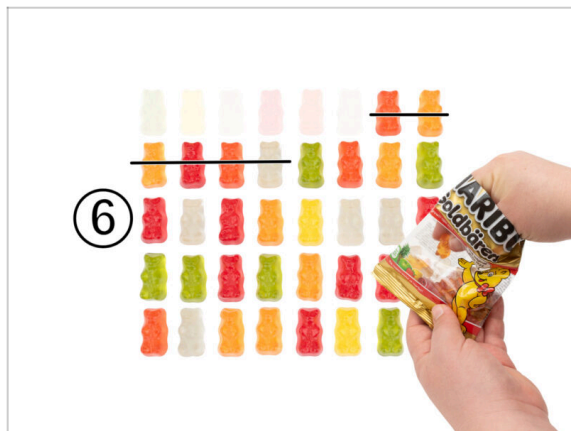

📌 Now is the time for a well-deserved boost.

- 🖤 Zjedz sześć żelków.

## KROK 39 Done



- ◆ Congratulations! You have just upgraded the Z-axis.
- ◆ Przejdźmy do kolejnego rozdziału.

## 4. Głowica INDX i boczne czujniki filamentu



## KROK 1 Narzędzia niezbędne w tym rozdziale

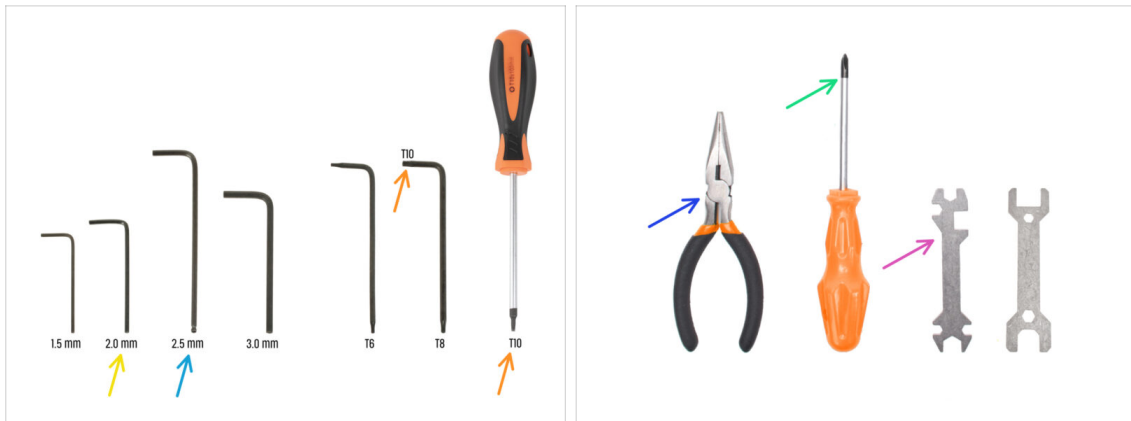

● **Do tego rozdziału przygotuj:**

- 2.0mm Allen key
- 2.5mm Allen key
- T10 key / screwdriver
- Needle-nose pliers *or flush cutters for cutting zip ties*
- PH2 screwdriver
- Universal wrench

## KROK 2 Loosening the belts

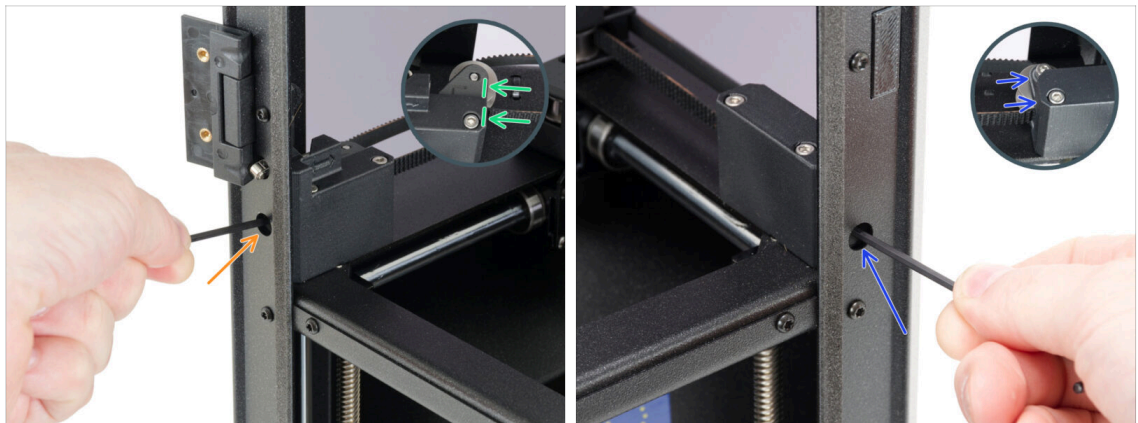

- The belt tensioning screw is located in the front left profile under the upper hinge.
- Using a 2.5 mm Allen key, loosen the tensioning mechanism until the idler is flush with the tensioner.
- 🔧 Typically, this requires 8–10 turns. **Be careful not to loosen the screw all the way!**
- ⓘ If you accidentally loosen the belt tensioning screw all the way, ensure the nut inserted into the back of the tensioner does not fall out.
- Move to the opposite side and loosen the tensioning mechanism until the idler is flush with the tensioner.

## KROK 3 Releasing the belts

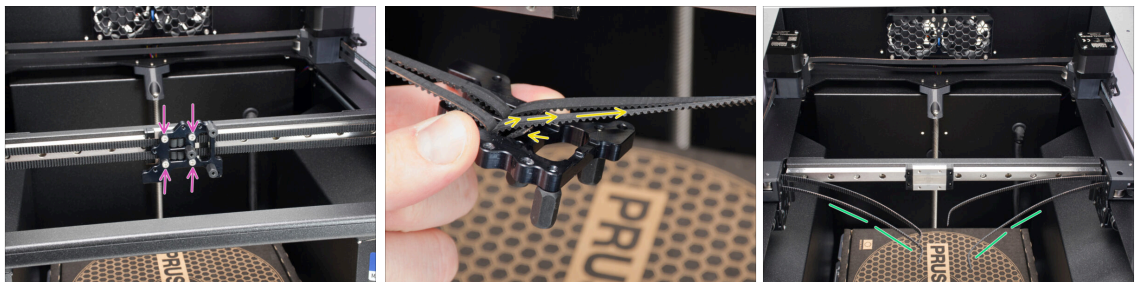

- Using the 2.5mm Allen key, remove four M3x10 screws securing the Nextruder holder.
- Disengage all four belt ends from the Nextruder holder slots.
- Remove the Nextruder holder.
- ⓘ This part will no longer be needed.
- Let the loosened belts hang freely.
- ⚠ **CAUTION: Do not pull on the belts, as they could slip out of the motor pulleys and require full disassembly for reinstallation.**

## KROK 4 Gantry aligner tool: parts preparation

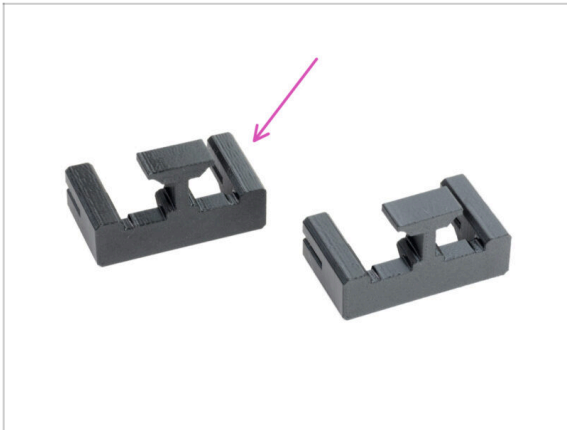

- Do kolejnych etapów przygotuj:
- INDX-Gantry-aligner-tool (2x) found in the Position tools bag

## KROK 5 Installing the Gantry-aligner-tool - right

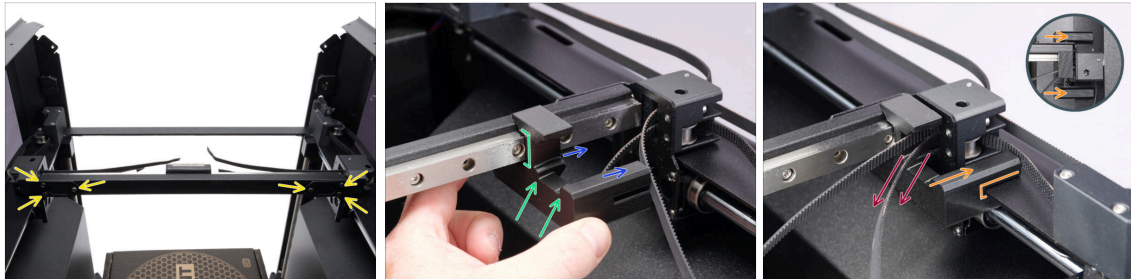

- Start by slightly loosening three screws on the back of the gantry on each side.
- Place one of the the Gantry-aligner-tool on the **front right side** of the X-axis, aligning the **linear rail with the matching cutout**.
- i** Both Gantry-aligner-tools are identical.
- The fork must face the pulleys.
- Slide the Gantry-aligner-tool fully onto the gantry frame profile, ensuring the cutouts engage.
- Route both free belt ends through the open space above the tool.

## KROK 6 Installing the Gantry-aligner-tool - left

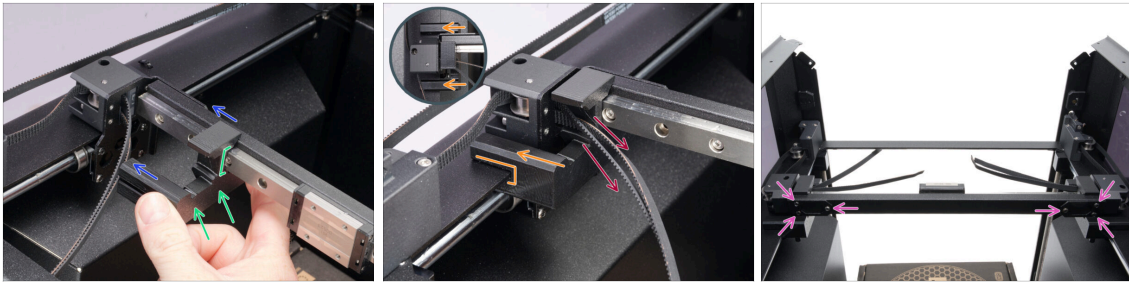

- ◆ With each Gantry-aligner-tool in place, tighten the three screws on each side of the back of the gantry.
- ◆ Place the Gantry-aligner-tool on the **front left side** of the X-axis, aligning the **linear rail with the matching cutout**.
- ◆ The fork must face the pulleys.
- ◆ Slide the Gantry-aligner-tool fully onto the gantry frame profile, engaging the cutouts.
- ◆ Route both free belt ends through the open space above the tool.

## KROK 7 Wyrównanie prowadnicy liniowej



- ◆ Using a 2.5 mm Allen key, loosen all six screws securing the linear rail.
- ◆ Move the linear bearing back and forth along the full length of the axis.
- ◆ **Firmly tighten** all six screws one by one in the **specified order**.

## KROK 8 Removing the Gantry-aligner-tool

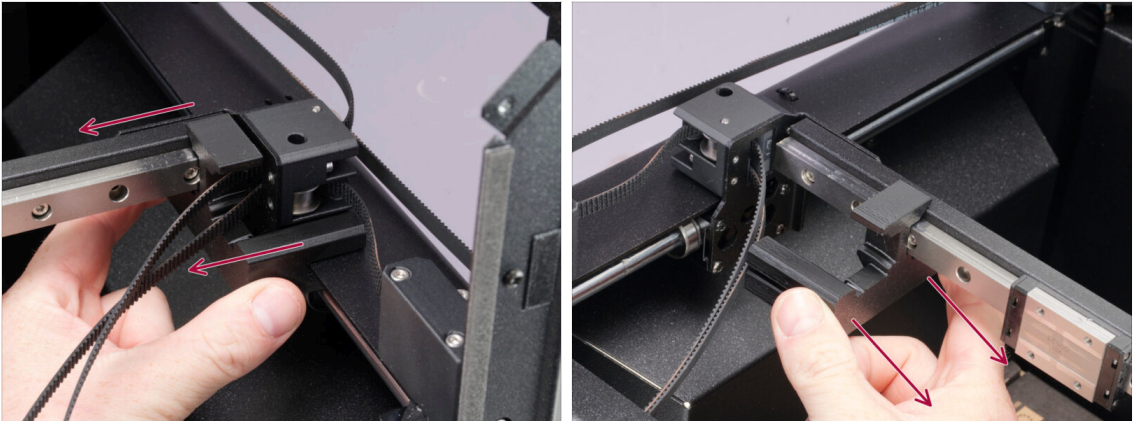

◆ Remove both Gantry-aligner-tools from the printer.

ⓘ This part will no longer be needed.

## KROK 9 Print head mount: parts preparation

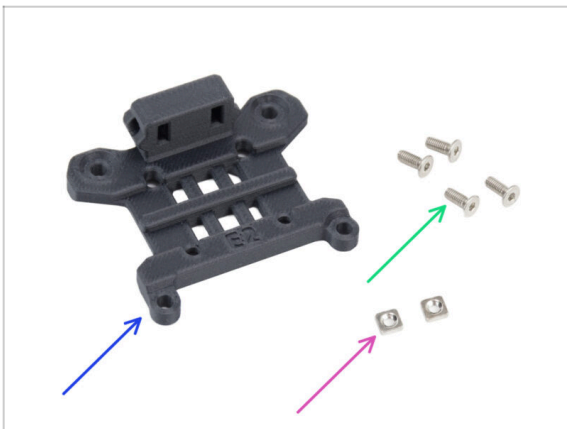

◆ Do kolejnych etapów przygotuj:

◆ INDX-Head-mounting-plate (1x)  
*found in the Toolhead bag*

◆ M3x8b screw (4x) *found in the  
Fasteners 1/2 bag*

◆ M3nS nut (2x) *found in the  
Fasteners 2/2 bag*

## KROK 10 Securing the belts

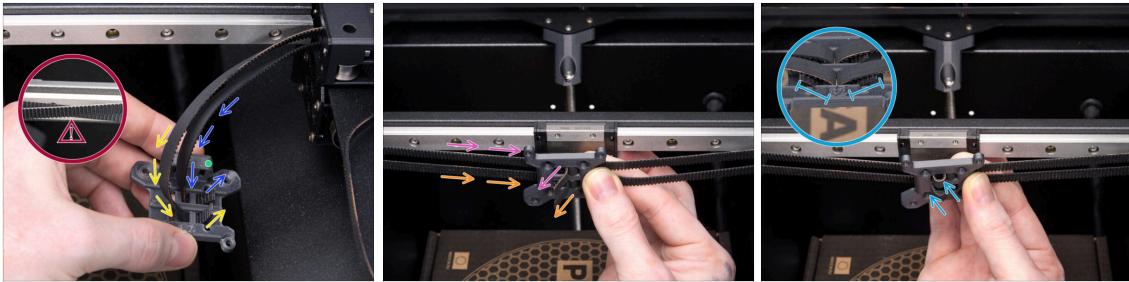

- ◆ Hold the Head-mounting-plate in the correct orientation, using the protrusion as a guide.
- ◆ From the right side, route the **lower belt** through the **rear center opening** in the Head-mounting-plate, around the post, and back out. It must extend **4-5 teeth**.
- ◆ Route the **upper belt** through the **front center opening** in the Head-mounting-plate, around the post, and back out. It must extend **4-5 teeth**.
- ⚠ **Make sure the belts are not crossed.**
- ◆ **Hold the right belts in place with your thumb to prevent them from slipping out.**
- ◆ Route the **upper belt** through the **front center opening** out (down) of the Head-mounting-plate. It must extend **6-7 teeth**.
- ◆ From the left side, route the **lower belt** through the **rear center opening** out (down) of the Head-mounting-plate. It must extend **6-7 teeth**.
- ◆ Insert the **belt ends from the left side** into the **left opening** and press them in. Leave 4-5 teeth protruding on from the rear side of the Head-mounting-plate.

## KROK 11 Installing the Head-mounting-plate

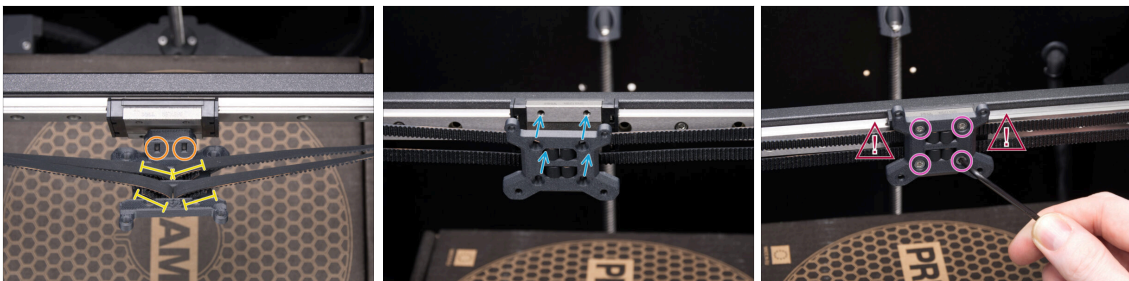

- ◆ Double-check that **all four belt ends protrude 4-5 teeth** inward.
- ◆ Insert two M3nS nuts into the protrusion of the Head-mounting-plate.
- ◆ Place the Head-mounting-plate against the linear bearing and align it with the holes.
- ◆ Using a 2.0 mm Allen key, secure the part with four M3x8b screws. Tighten the screws **firmly, but gently**.
- ⚠ **Check on both sides that the belts are correctly routed through their channels and are not pinched anywhere.**

## KROK 12 Adjusting the belts



- Locate the tensioning screws in the front left and front right profiles.
- Using a 2.5 mm Allen key, tension the belts so that both tensioning mechanisms are in approximately the same position as shown in the picture - about 8 mm (0.31 in) from the edge of the tensioner.

**i** Typically, this requires 8–10 turns.

**📌** Final fine-tuning will be done in the final chapter.

## KROK 13 INDX Toolhead assembly: Parts preparation



- **Do kolejnych etapów przygotuj:**
- INDX Toolhead (1x) *found in the main box*
- Cable-strain-relief (1x) *found in the Cable strain relief bag*
- M3x16T screw (1x) *found in the Cable strain relief bag*

## KROK 14 Attaching the cable strain relief

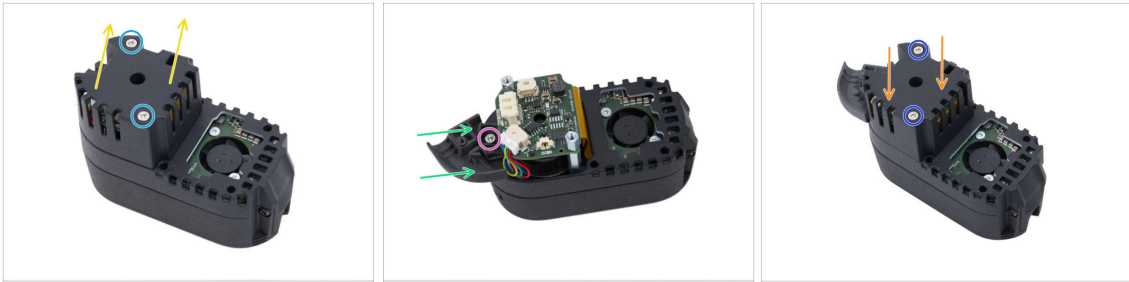

- ◆ Use the T10 key/screwdriver to remove two M3x6T screws.
- ◆ Remove the INDX Toolhead cover.
- ◆ Attach the front cable strain relief to the INDX Toolhead.
- ◆ Secure the front cable strain relief with the M3x16T screw.
- ◆ Carefully attach the INDX Toolhead cover. **Ensure that no cables are pinched.**
- ◆ Secure the cover in place with the two M3x6T screws you removed earlier.

## KROK 15 INDX Toolhead: parts preparation



- ◆ **Do kolejnych etapów przygotuj:**
- ◆ INDX Toolhead (1x) *that you assembled earlier*
- ◆ M3x14 screw (4x) *found in the Fasteners 1/2 bag*

## KROK 16 Mounting the INDX Toolhead

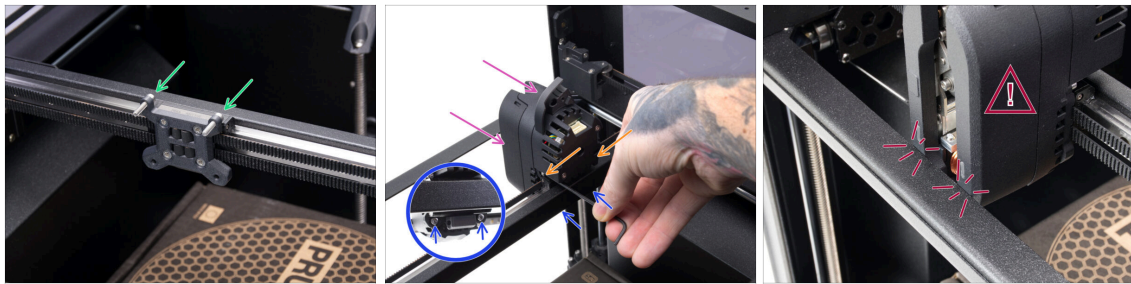

- ◆ From the rear side of the Head-mounting-plate, insert two M3x14 screws into the holes.
  - ◆ From the front side, place the INDX Toolhead onto the Head-mounting-plate as shown in the picture.
  - ◆ Secure it using the upper M3x14 screws and fully tighten them firmly.
  - ◆ Secure the INDX Toolhead by inserting two M3x14 screws into the lower holes and tightening them firmly.
- ⚠ **WARNING:** Avoid contact with the front metal LED holder to prevent damage or scratches to the INDX Toolhead.

## KROK 17 Kanał wentylatora: przygotowanie części

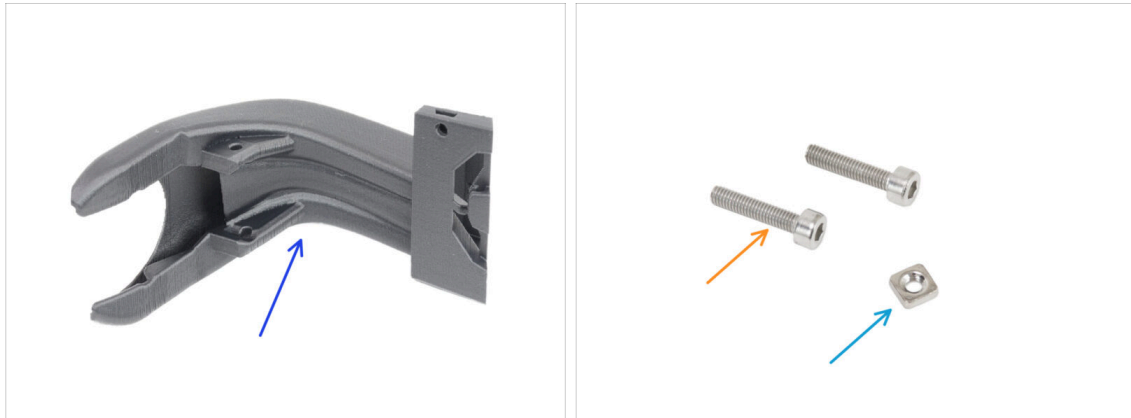

- ◆ **Do kolejnych etapów przygotuj:**
- ◆ INDX-C1-Fan-shroud (1x) *found in the Toolhead bag*
- ◆ M3x14 screw (2x) *found in the Fasteners 1/2 bag*
- ◆ M3nS nut (1x) *found in the Fasteners 2/2 bag*

## KROK 18 Attaching the Fan-shroud

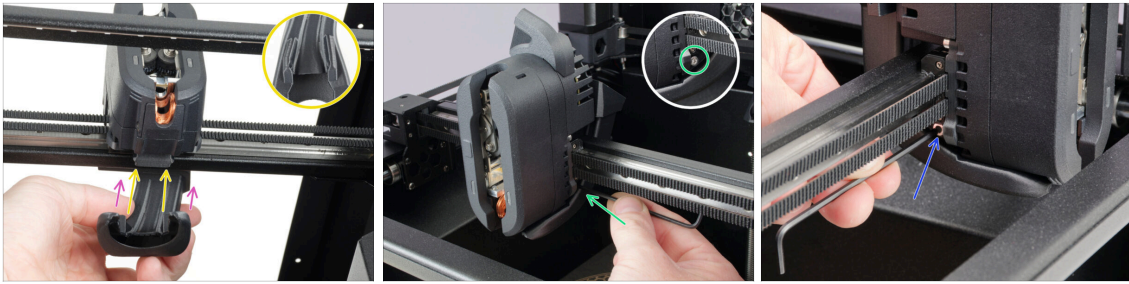

- ◆ Attach the Fan-shroud to the INDX toolhead from below.
- ◆ Note the ridge in the Fan-shroud. This ridge will slide onto the bottom part of the Head-mounting-plate.
- ◆ Secure the Fan-shroud using the M3x14 screw from the right side.
- ◆ Secure it from the left side using an M3x14 screw as well.

## KROK 19 Inserting the nut

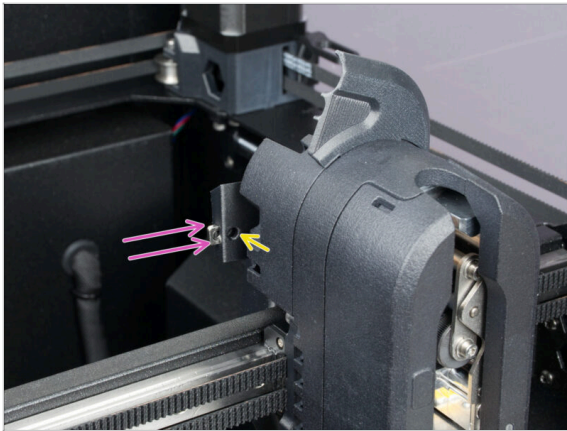

- ◆ Insert an M3nS nut into the protrusion on the left side of the INDX Toolhead.
- ◆ From the front, check through the screw hole that the nut is properly seated.

## KROK 20 Wentylator wydruku: przygotowanie części

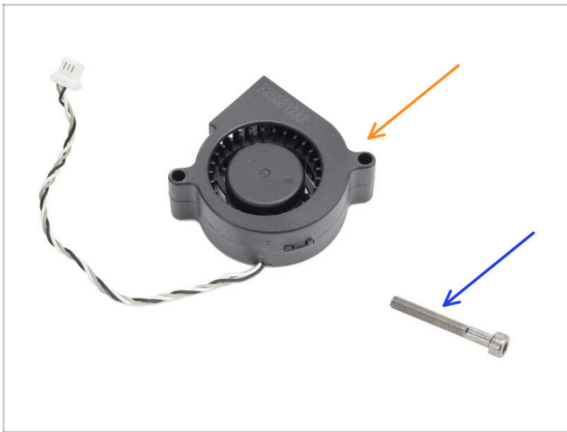

- Do kolejnych etapów przygotuj:
- Print fan (1x) removed earlier
- M3x25 screw (1x) found in the Fasteners 1/2 bag

## KROK 21 Installing the print fan

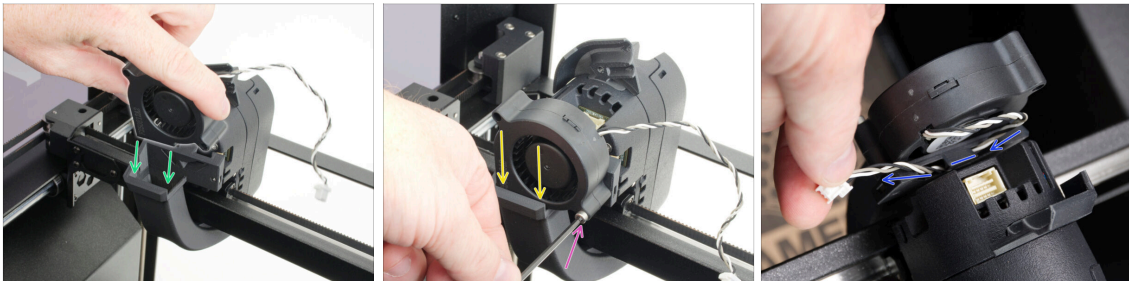

- Look at the INDX Toolhead from the rear side.
- Take the print fan as shown and align it with the Fan-shroud opening.
- Insert the print fan into the Fan-shroud opening.
- Secure it with one M3x25 screw.
- ⚠ Do not overtighten the screw to avoid cracking the fan housing.
- Guide the print fan cable under the cable hook on the Fan-shroud.

## KROK 22 Podłączenie wentylatora wydruku

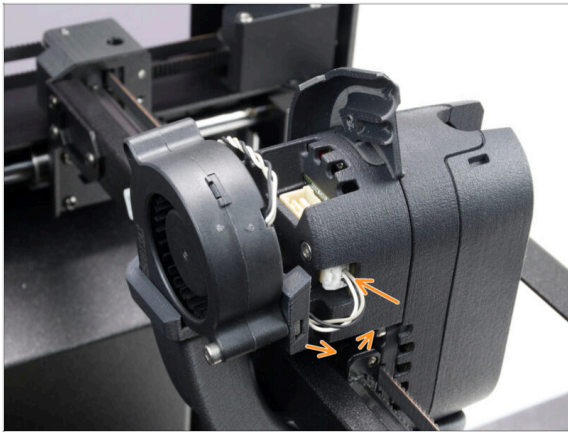

- Plug the print fan cable into the connector in the INDX Toolhead.
- Keep the cable from **protruding too far to the side**.

## KROK 23 INDX head cable: parts preparation I.



- Do kolejnych etapów przygotuj:**
- Head-cable-clip (1x) *found in the Toolhead bag*
- INDX-C1-Swing-arm-clip *found in the Toolhead bag*
- INDX-C1-Head-cable-cover (1x) *found in the Cable strain relief bag*
- Śruba M3x10 (1x) *wykręcona wcześniej*
- M3x8rT screw (1x) *found in the Fasteners 2/2 bag*
- M3x8rT self-tapping screw (1x) *found in the Cable strain relief bag*

## KROK 24 INDX head cable: parts preparation II.

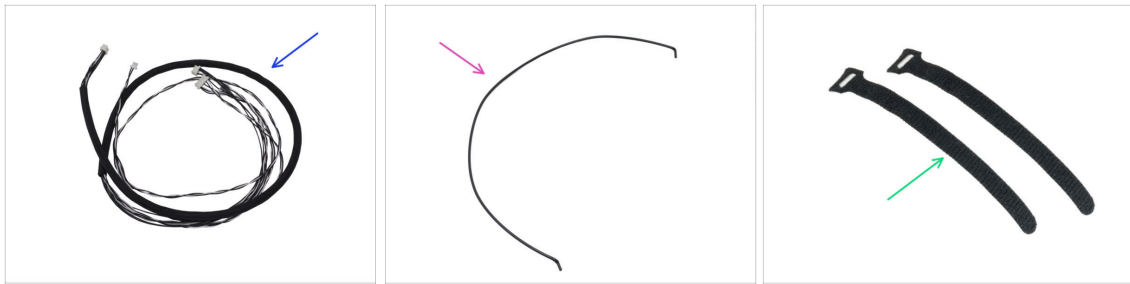

- ◆ INDX head cable (1x) *found in the Cables bag*
  - ◆ Nylon ?????? 4 x 2.5 x 450 (1x) *found in the main box ??????*
  - ◆ Cable tie (2x)
- 📌 Reuse the cable ties you removed earlier.

## KROK 25 Guiding the head cable



- ◆ Now move to the rear side of the printer.
  - ◆ Pass the head cable connector through the lower oval opening on the left side of the rear panel.
  - ◆ Insert most of the braided cable into the printer. The exact length will be adjusted later.
- 📌 Make sure the **grommet does not slide into the printer**. If needed, you can pull it outward for easier handling; it will be reinstalled later.
- ◆ Inside the printer, route the head cable upward through the corner behind the gantry assembly.

## KROK 26 Inserting the Nylon



- In this step, we will insert the nylon into the cable sleeve.
- Insert the Nylon into the cable sleeve near the head cable connector.
  - Ensure that the nylon is completely wrapped inside the sleeve, along with the head cable.
- Continue inserting the nylon into the cable sleeve along the whole length.
- Leave the end of the nylon sticking out from the cable sleeve as shown.
- Tighten the cable sleeve around the head cable and the nylon insert by gently twisting the sleeve.

## KROK 27 Connecting the head cable



- Plug the head cable into the print head. Ensure that the safety latch clicks in place.
- Insert the nylon into the slot in the print head. Ensure that the nylon is inserted all the way in.
- Insert the cables into the channel. Ensure that no cables are sticking out.
- Adjust the textile sleeve so that 1.5 cm (0.59 in) is inside the channel.
- Note the protruding bit on the Head-cable-cover. It will fit into the slot in the INDX toolhead.
- Attach the Head-cable-cover.
- ⚠ **When attaching the Head-cable-cover, ensure you do not pinch or damage any cables.**
- Use the M3x8rT self-tapping screw to secure the Head-cable-cover in place.

## KROK 28 Attaching the head cable

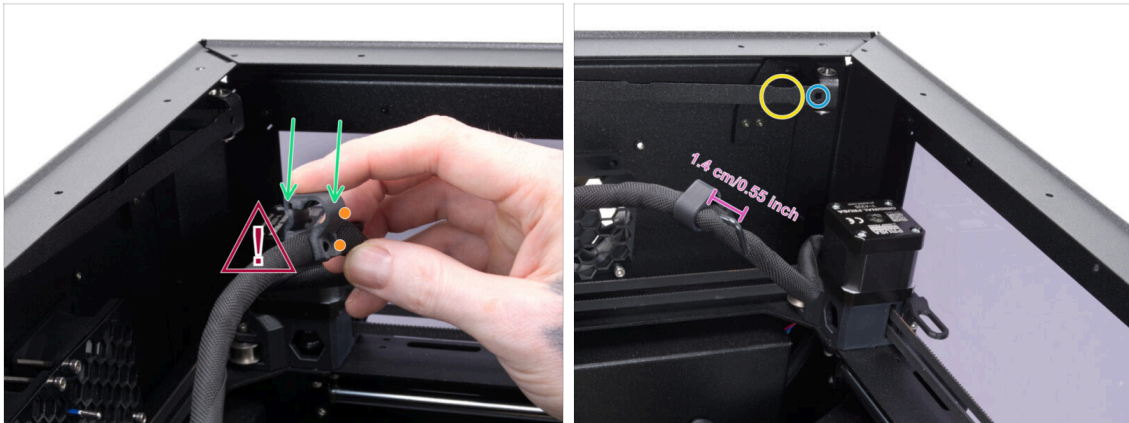

- Gently open up the **Swing-arm-clip** and attach it to the head cable with the nylon inside of the cable sleeve.
- ⚠ Proceed carefully. **Do not break the Swing-arm-clip** when attaching it to the head cable.
- Pay attention to the correct orientation; the protruding side of the clip and the side with the cut-out for the screw must face the front of the printer.
- Once the **Swing-arm-clip** is on the head cable, adjust it so the distance between the clip and the bend in the nylon is 1.4 cm / 0.55 inch
- Locate the rightmost narrowing on the swing arm. We will mount the **Swing-arm-clip** there in the next step.
- Note the hole in the swing arm. This is where we will insert the nylon end in the next step.

## KROK 29 Securing the swing arm clip



- ◆ Attach the Swing-arm-clip to the swing arm from the top. Ensure that the **clip is placed on the rightmost narrowing** on the swing arm.
- ◆ Insert the end of the nylon into the hole in the swingarm.
- 📌 Ensure that the cable sleeve is not pinched where the nylon is sticking out.
- ◆ With the Swing-arm-clip and the nylon in the correct positions, secure the clip in place with the M3x8rT screw.

## KROK 30 Securing the main cable

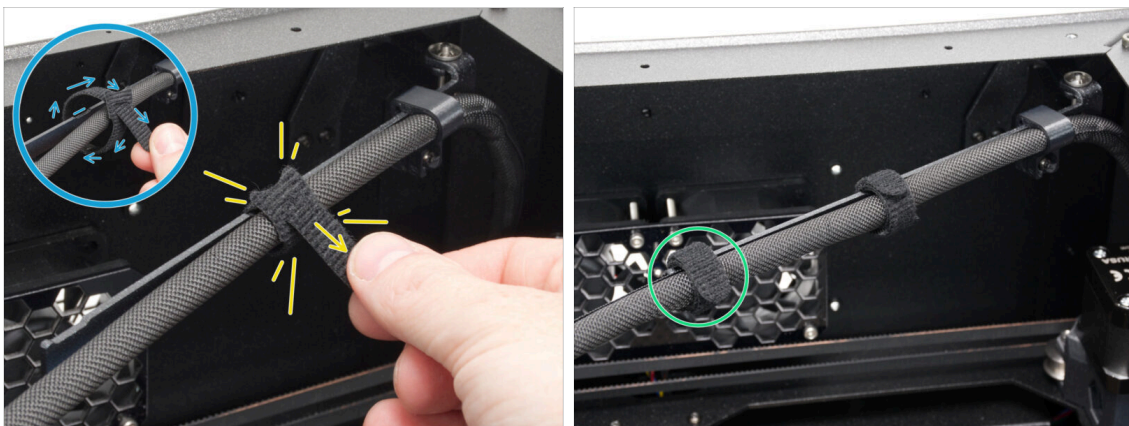

- ◆ Wrap the cable tie around the head cable and the middle narrowing of the swing arm.
- ◆ Tighten the cable tie and wrap the excess strap around it.
- ◆ Secure the head cable with the cable tie around the leftmost narrowing on the Swing arm.

## KROK 31 Installing the Head cable clip

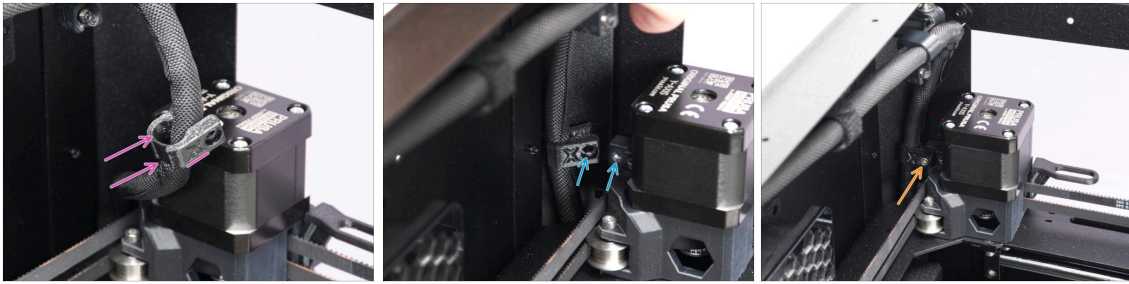

- Make sure that the cable sleeve is tightly wrapped around the cables. Twist the cable sleeve slightly to make it tighter.
- Carefully open the Head-cable-clip and attach it to the head cable.
- 📌 **Pay attention to the correct orientation**, using the "X" symbol and the cutout for the screw head as a guide.
- Align the Head-cable-clip with the hole on the Y motor mount protrusion.
- Secure the part using an M3x10 screw.
- ⓘ *Pro tip:* Pre-thread the M3x10 screw into the part after snapping it onto the cable.

## KROK 32 Connecting the head cable: parts preparation

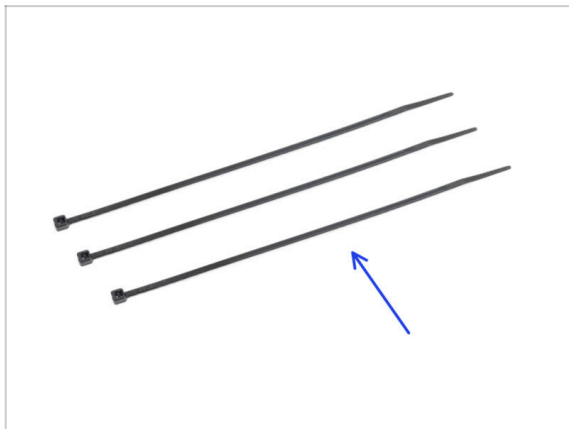

- **Do kolejnych etapów przygotuj:**
- Zip tie (3x)

### KROK 33 Opaski zaciskowe

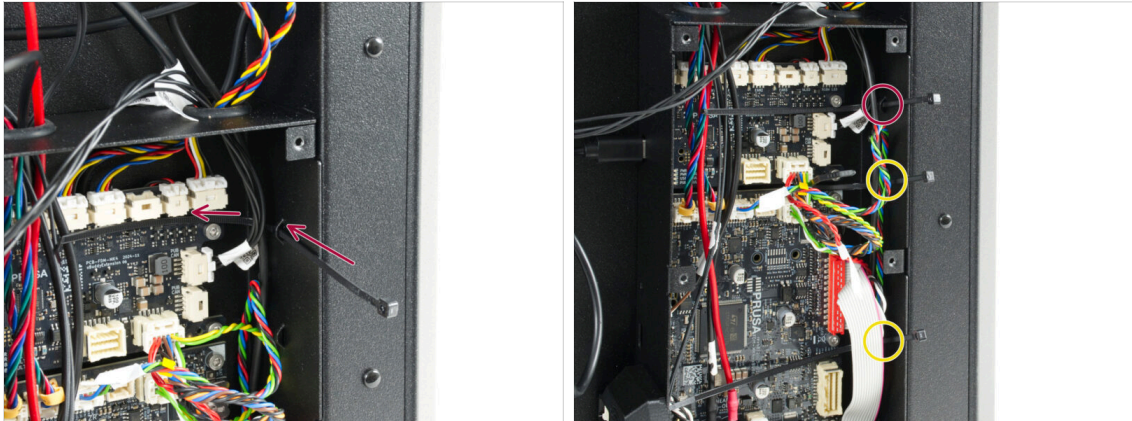

- Pass the zip tie through the upper perforation in the xBuddy box. The zip tie must run underneath all cables.
- Do the same for the other two perforations.

### KROK 34 Connecting the head cable

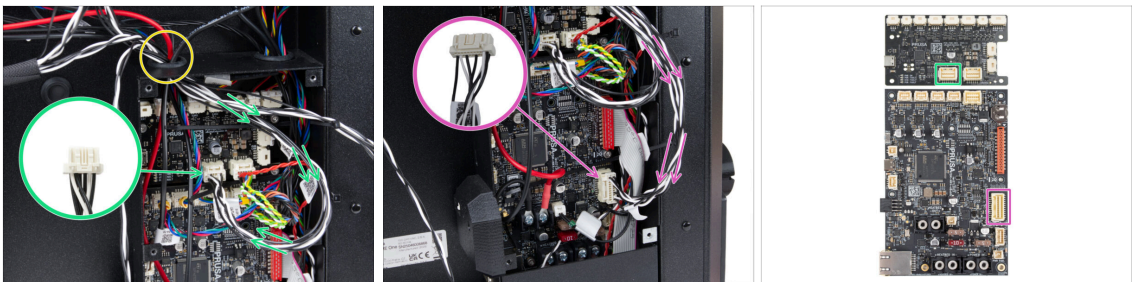

- Guide the head cable through the left opening in the xBuddy box.
- Plug the branched head cable connector as follows:
  - **Narrow connector:** plug it into the **MMU**-labeled slot on the **xBuddy Extension** board.
  - **Wide connector:** plug it into the **Nextruder**-labeled slot on the **xBuddy** board.
- Guide the main cable **under** the grey xLCD ribbon cable.

## KROK 35 Securing the cables

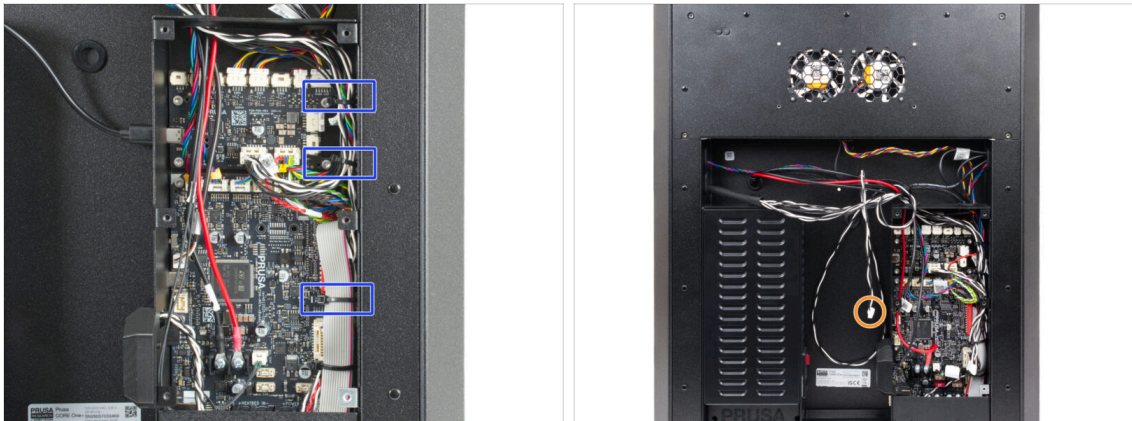

- Adjust the cable management according to the picture. Route all cables along the edges.
- Tighten the zip ties on the right side and trim the excess.
- ⚠ **Do not overtighten to avoid damaging the cables.**
- **Leave the last connector of the head cable unplugged.** This will be done later on when we connect the dock fan.
  - We recommend hanging the cable on the other cables so it does not get damaged when turning the printer.

## KROK 36 Haribo time!



- 📌 Time for a little yummy gummy break.
- Take a small reward break: eat five gummy bears.

## KROK 37 INDX PTFE holders: parts preparation

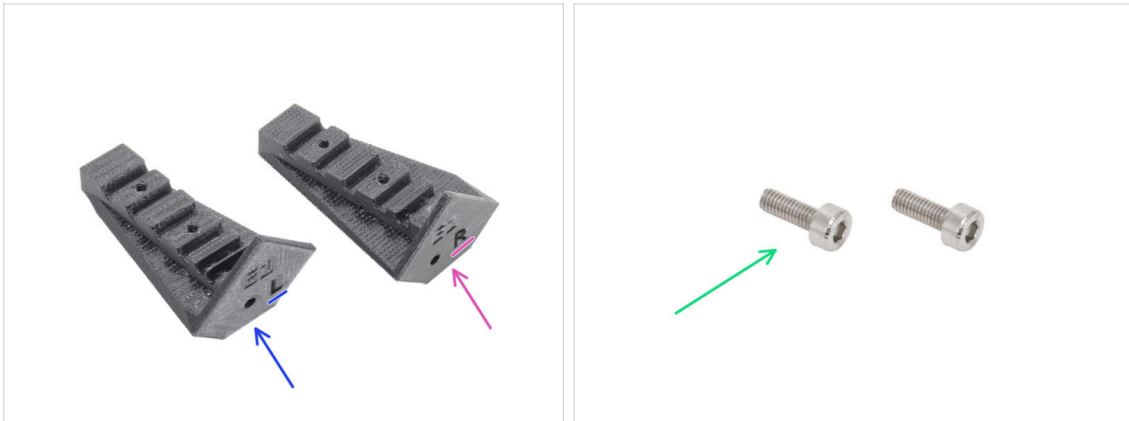

- Do kolejnych etapów przygotuj:
- INDX-PTFE-holder-left (1x) *marked "L"*
- INDX-PTFE-holder-right (1x) *marked "R"*
- Śruba M3x10 (2x) *wykręcone wcześniej*

## KROK 38 Installing the PTFE-holder-left



- Using the 2.5mm Allen key release and remove two M3x4 screws securing the top rear profile.
- Take the PTFE-holder-**left** and insert one M3x10 screw.
- Align the PTFE-holder-left with the **left** hole on the top rear profile.
- Join both parts by fully tightening the M3x10 screw.

### KROK 39 Installing the PTFE-holder-right

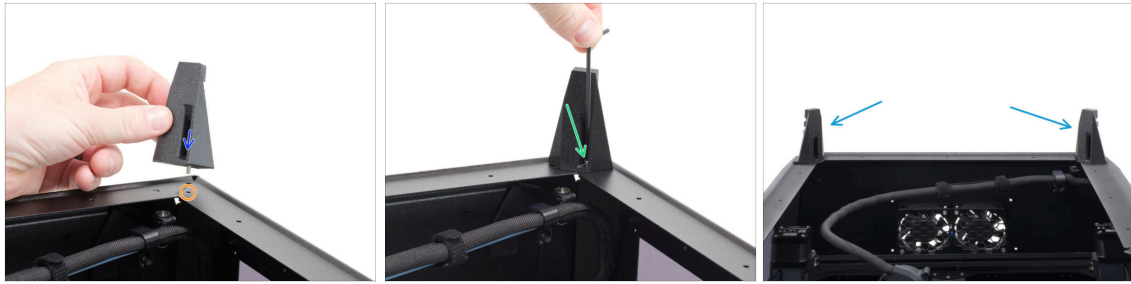

- ◆ Take the PTFE-holder-**right** and insert one M3x10 screw.
  - ◆ Align the PTFE-holder-right with the **right** hole on the rear profile.
  - ◆ Join both parts by fully tightening the M3x10 screw.
  - ◆ Visually compare both PTFE holders with the picture.
- ⚠ Now move outside the printer area, as you will prepare the filament sensors.

### KROK 40 Side filament sensors: parts preparation



- ◆ **Do kolejnych etapów przygotuj:**
- ◆ INDX-C1-FS-top (1x) *found in the Filament holder L bag*
  - ◆ INDX-C1-FS-top (1x) *found in the Filament holder R bag*
  - ⓘ Note that each part has a different position numbering.
  - ◆ Sleeve 2x5 (4x) *found in the Fasteners Tools INDX bag*
  - ◆ Collet (4x) *found in the Fasteners Tools INDX bag*
  - ◆ M3x12cT screw (2x) *found in the Fasteners 2/2 bag*
  - ◆ Magnet 3.2 x 5 (2x) *found in the Fasteners Tools INDX bag*

## KROK 41 Inserting the sleeves



- ◆ Insert the 2x5 sleeves into the indicated positions in the square opening of the FS-top.
- ◆ Push each sleeve **fully into place** using a non-sharp tool. It will click when correctly seated.
- ◆ **Check from the side that each sleeve is in the correct position:**
  - ◆ The sleeve is in the correct position.
  - ◆ The sleeve needs to be pushed further.
- ◆ Repeat this procedure for all the sleeves on both FS-top parts.

## KROK 42 Inserting the collets



- ◆ Position the FS-top with the square openings facing down.
- ◆ Insert the collets into the top openings.
- ◆ Use this procedure for both FS-top parts.

## KROK 43 Installing the magnets



- ◆ Insert the 5x2 magnet into the FS-top with the cut-out facing up.
- ◆ Secure the magnet with the M3x12cT screw.
  - ⓘ The magnet may stick to the T10 key during tightening; hold it in place by hand.
- ◆ Repeat the same process to install the remaining magnets on both FS-top parts.

## KROK 44 Assembling the FS: parts preparation I



- ◆ **Do kolejnych etapów przygotuj:**
- ◆ Steelball 7mm (8x) found in the *Fasteners Tools INDX bag*.
- ◆ Magnet 7x8 (8x) found in the *Fasteners Tools INDX bag*

## KROK 45 Assembling the FS: parts preparation II



### Do kolejnych etapów przygotuj:

- INDX-C1-FS-holder (1x) found in the Filament holder L bag
- INDX-C1-FS-holder (1x) found in the Filament holder R bag
- Filament sensor board Left (1x) found in the electronics box
- Filament sensor board Right (1x) found in the electronics box
- M3x12cT screw (8x) found in the Fasteners 2/2 bag

## KROK 46 Inserting the steel balls



- Insert one steelball 7mm into each round hole.
- Repeat the process with the second FS-top part.

## KROK 47 Attaching the magnets

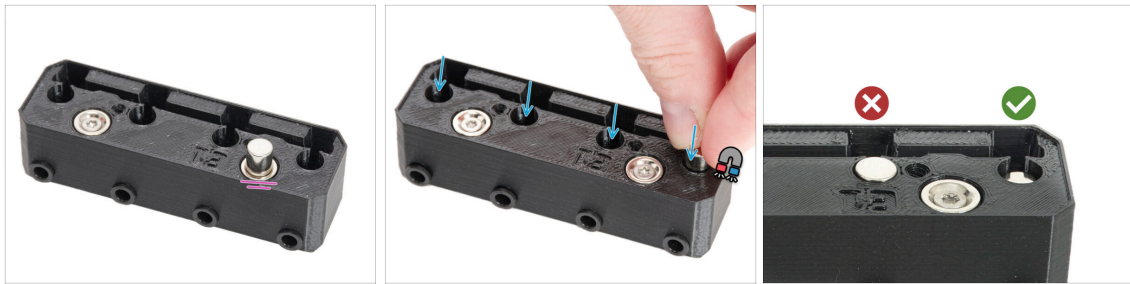

- ❗ **The magnets are quite strong.** Make sure that you keep both parts far from each other.
- 🟡 Place one of the 7x8 magnets onto the 5x2 magnet. Note which side **attracts the magnet**.
- 🟢 Insert the magnet in the same hole as you placed the steelball 7mm.
  - ⚠️ **Make sure that you insert the magnet with the attracting side going first.**
- ⬛ **Check that you have the correct position of the magnets:**
  - 🔴 **NOT OK:** When the **magnet is poking out**, it needs to be flipped and inserted again correctly.
  - 🟢 **OK:** The **magnet is seated flush** in the hole.

## KROK 48 Assembling the FS-top left

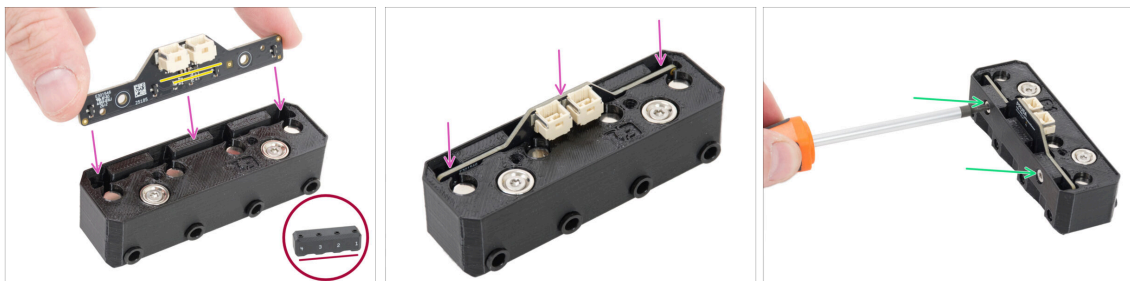

- 🔴 Prepare the FS-top assembly (**positions 4-1**).
- 🟡 Insert the filament sensor board **LEFT** (with two connectors) into the ridge in the filament sensor holder top.
  - 🟡 Make sure the connectors are correctly oriented relative to the printed part.
  - ⬛ Insert the part fully down.
- 🟢 Secure the part using two M3x12cT countersunk screws.

## KROK 49 Assembling the FS-top right

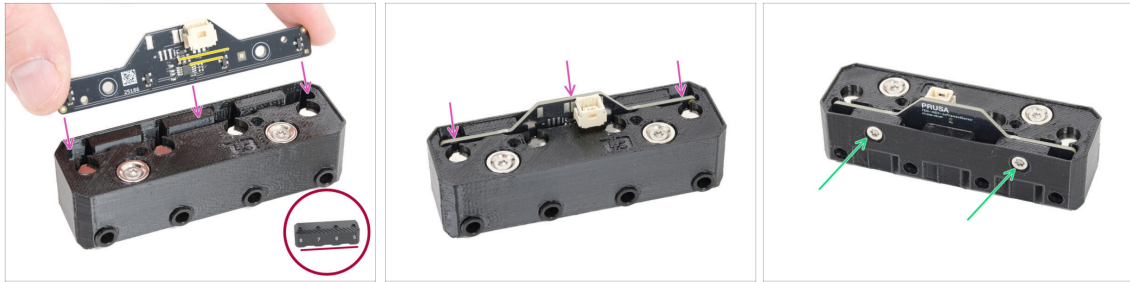

- Prepare the FS-top assembly with the **(positions 8-5)**.
- Insert the filament sensor board **RIGHT** (with one connector) into the ridge in the filament sensor holder top.
  - Make sure the connector are correctly oriented relative to the printed part.
  - Insert the part fully down.
- Secure the part using two M3x12cT countersunk screws.

## KROK 50 Covering the filament sensor - left



- Let's start with the left filament sensor assembly (positions 4-1).
- Place the FS-holder onto the filament sensor assembly, ensuring the **connectors pass through the rectangular opening**.
- Use the two M3x12cT screws to secure the board in place. Tighten them firmly.

## KROK 51 Covering the filament sensor - right



- Prepare the filament sensor assembly right (positions 8-5).
- Place the FS-holder onto the filament sensor assembly, ensuring the **connector pass through the rectangular opening**.
- Use the two M3x12cT screws to secure the board in place. Tighten them firmly.

## KROK 52 PTFE tubes - left side: parts preparation



- **Do kolejnych etapów przygotuj:**
- Filament sensor cable (2x) *found in the Cables bag*
- 3x12sT screw (2x) *found in the Fasteners 2/2 bag*
- PTFE tube 4 x 2.5 x 880 (4x) *found in the main box*

## KROK 53 Preparing the filament sensor - left



- ◆ Remove the upper center nylon rivet from the left transparent side panel.
- ◆ Insert a 3x12sT screw from the inside into the rivet hole.
- ◆ Take the filament sensor assembly with the two connectors (positions 4-1) and connect the two filament sensor cables to it.
- ⓘ Both ends of the cable are identical and can be connected interchangeably.
- ◆ Set the right filament sensor (positions 8-5) aside for now. You will need it later.
- ◆ Guide the cables out through the cable channels on the left side.

## KROK 54 Mounting the filament sensor - left

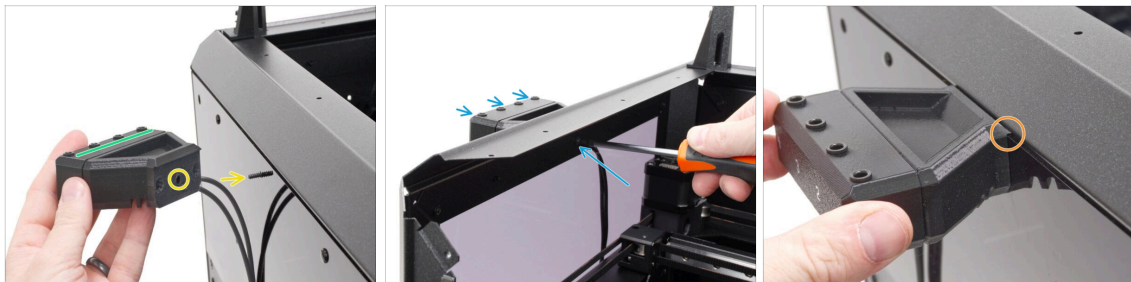

- ◆ Align the left filament sensor assembly with the protruding 3x12sT screw.
- ◆ Ensure correct orientation - the collets must face upward.
- ◆ Fully tighten the screw to secure the assembly. **Make sure that:**
  - ◆ The tab along the top edge is seated in the gap above the transparent side panel.

## KROK 55 Connecting the PTFE tube - left

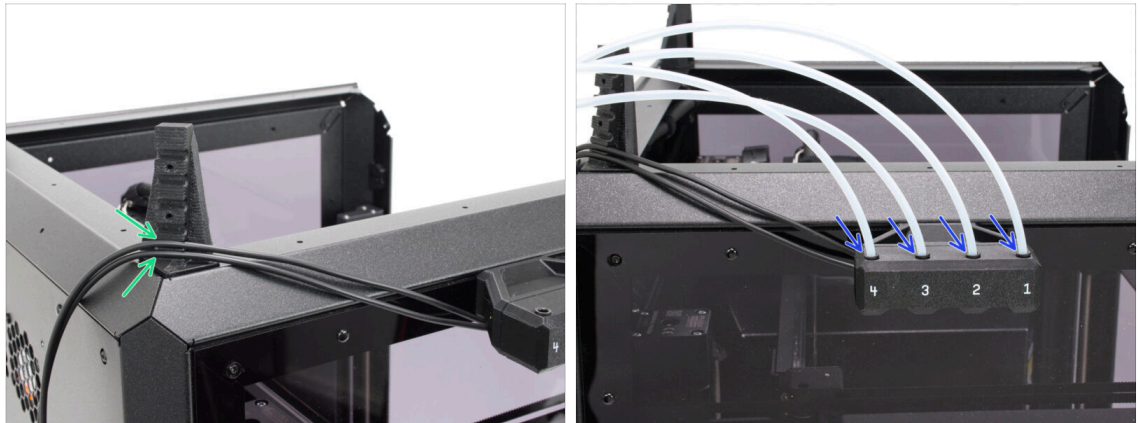

- Insert both filament sensor cables into the lower cable channels in the PTFE-holder.
  - The cables should neither sag nor be under tension along the route.
- Insert four PTFE tubes into the collects in the filament sensor.
  - Gently pull on the tube to verify it is locked in the collet.

## KROK 56 PTFE measurement: parts preparation

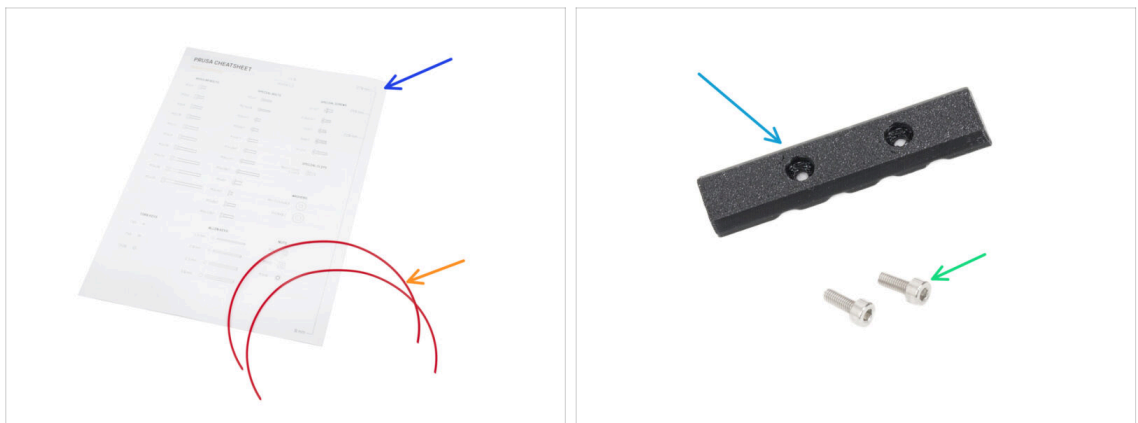

- **For the following parts, please prepare:**
- Prusa Cheatsheet (1x)
  - ⓘ It is on the reverse side of the welcome letter you received at the beginning of the package.
- Filament 300 mm (2x)
  - ✂ Cut two pieces of filament at least 300 mm long. We recommend using PETG, but it's not required.
  - ⓘ If you have a 300 mm gauge, you can use it as an alternative.
- INDX-PTFE-holder-cover (1x) *found in the Filament holder left bag*
- M3x10 screw (2x) *you removed earlier*

## KROK 57 Attaching the PTFE tubes - left



- ◆ Insert two M3x10 screws through the INDX-PTFE-holder-cover and keep the part nearby.
- ◆ Guide all four PTFE tubes through the channels in the PTFE-holder. Hold them in place by hand to prevent them from falling out.
  - ⚠ Make sure the filament sensor cables are routed in the lower channels.
- ◆ Place the PTFE-holder-cover over the PTFE tubes and the cables. The part is not symmetrical, install it with the longer side facing down.
  - ◆ **Do not fully tighten it;** the PTFE tubes must be able to move back and forth.

## KROK 58 Measurement info



📌 In the following steps, you will measure the correct PTFE tube length between the PTFE-holder and the filament sensor. You can use a measuring tape or the filament method described below.

- ◆ Along the side of the Prusa Cheatsheet, note the scale in millimeters - these indicate the required PTFE tube lengths.
- ◆ The initial length is 300 mm. **Do not shorten it yet.**
- ⓘ In the following steps, you will be instructed to shorten the filament to the required length.
- ◆ Keep the second piece of filament for the right side.

## KROK 59 Inserting the PTFE tubes (position 1,2)



- ◆ Place one end of the filament at the filament sensor against the PTFE tube at **position 1**.
- ◆ Place the other end against the same PTFE tube at the PTFE-holder.
- ◆ Slide the filament in the PTFE-holder to match the PTFE tube length.
- 📌 Cut the filament to **270 mm**.
- ◆ Adjust the PTFE tube to **position 2** according to the shortened filament.
- ◆ Fully tighten the upper screw.
- ⓘ This will lock the first PTFE tubes in place and prevent movement.

## KROK 60 Inserting the PTFE tubes (position 3,4)



- 📌 Cut the filament to **240 mm**.
- ◆ Adjust the PTFE tube to **position 3** according to the shortened filament.
- 📌 Cut the filament to **210 mm**.
- ◆ Adjust the PTFE tube to **position 4** according to the shortened filament.
- ◆ Fully tighten the lower screw.

## KROK 61 PTFE tubes - right side: parts preparation

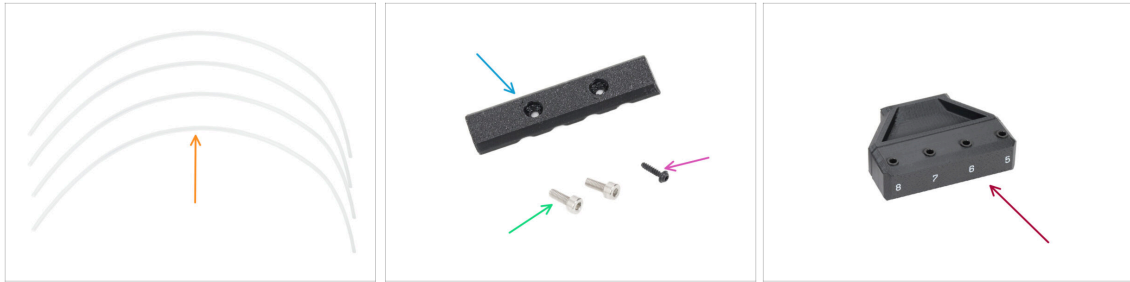

### Do kolejnych etapów przygotuj:

- PTFE tube 4 x 2.5 x 880 (4x) *found in the main box*
- INDX-PTFE-holder-cover (1x) *found in the Filament holder left bag*
- 3x12sT screw (2x) *found in the Fasteners 1/2 bag*
- Śruba M3x10 (2x) *wykręcone wcześniej*
- Right side filament sensor (1x) *scale 8-5*

## KROK 62 Preparing the filament sensor - right



- Remove the upper center nylon rivet from the left transparent side panel.
- Insert a 3x12sT screw from the inside into the rivet hole.
- Take the filament sensor assembly with the one connector (positions 8-5) and connect the filament sensor cable to it.
- Guide the cables out through the cable channels on the left side.

## KROK 63 Mounting the filament sensor - right

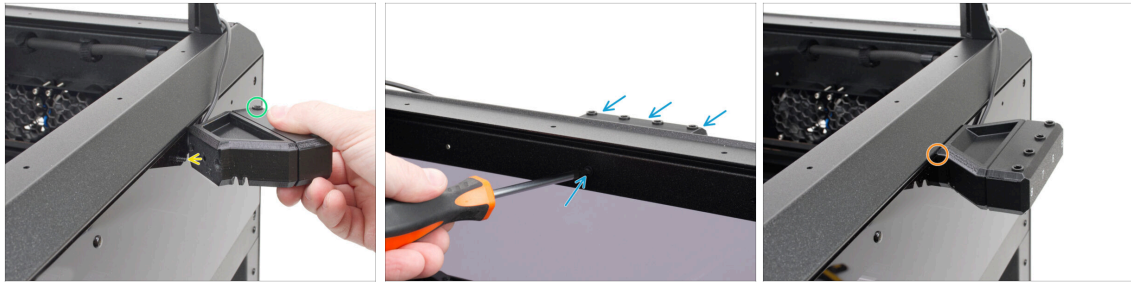

- ✦ Align the right filament sensor assembly with the protruding 3x12sT screw.
- ✦ Ensure correct orientation - the collets must face upward.
- ✦ Fully tighten the screw to secure the assembly. **Make sure that:**
  - ✦ The tab along the top edge is seated in the gap above the transparent side panel.

## KROK 64 Connecting the PTFE tube - right



- ✦ Insert the filament sensor cable into the lower cable channel in the PTFE-holder.
  - Let the excess cable hang freely at the back of the printer.
- ✦ Insert four PTFE tubes into the collects in the filament sensor.
  - Gently pull the tube to verify it is locked in the collet.

## KROK 65 Attaching the PTFE tubes - left

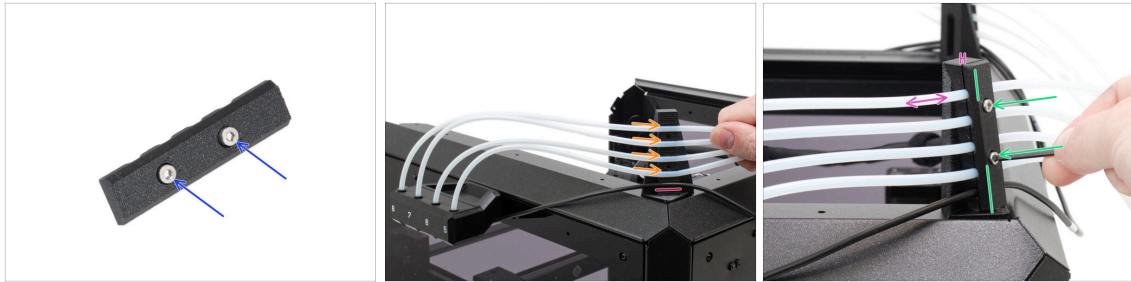

- ◆ Insert two M3x10 screws through the INDX-PTFE-holder-cover and keep the part nearby.
- ◆ Guide all four PTFE tubes through the channels in the PTFE-holder. Hold them in place by hand to prevent them from falling out.
  - ⚠ Make sure the filament sensor cable is routed in the lower channel.
- ◆ Place the PTFE-holder-cover over the PTFE tubes and the cables. The part is not symmetrical, install it with the longer side facing down.
  - ◆ Do not fully tighten it; the PTFE tubes must be able to move back and forth.





## KROK 66 Inserting the PTFE tubes (position 5,6)

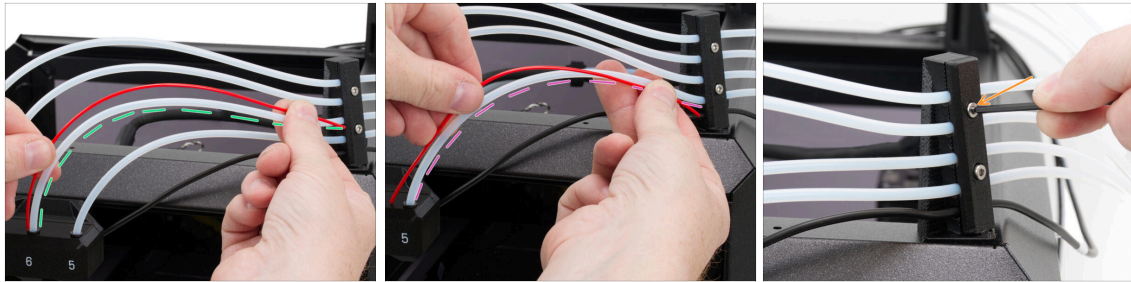

- ◆ Prepare the Prusa Cheatsheet and the second 300-mm filament.
- ◆ Place one end of the filament at the filament sensor against the PTFE tube at **position 5**.
- ◆ Place the other end against the same PTFE tube at the PTFE-holder.
  - ◆ Slide the filament in the PTFE-holder to match the PTFE tube length.
- 📌 Cut the filament to **270 mm**.
  - ◆ Adjust the PTFE tube to **position 6** according to the shortened filament.
  - ◆ Fully tighten the upper screw.
  - ⓘ This will lock the first PTFE tubes in place and prevent movement.



## KROK 67 Inserting the PTFE tubes (position 7,8)

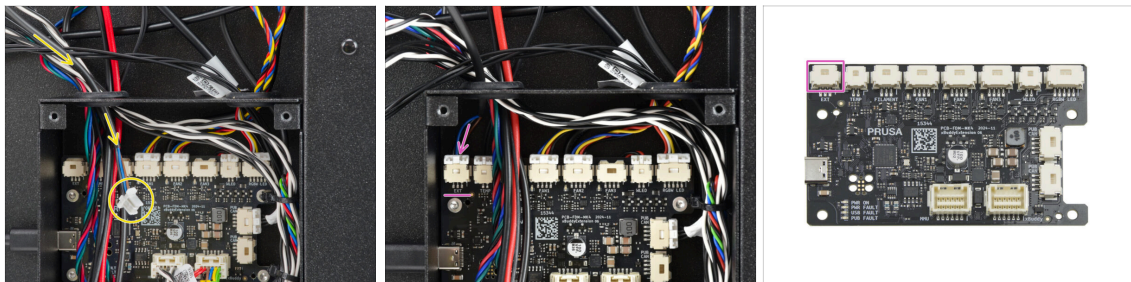

-  Cut the filament to **240 mm**.
-  Adjust the PTFE tube to **position 7** according to the shortened filament.
-  Cut the filament to **210 mm**.
-  Adjust the PTFE tube to **position 8** according to the shortened filament.
-  Fully tighten the lower screw.

## KROK 68 Connecting the filament sensor cable



-  Route the remaining loose end of the filament sensor cable through the left opening in the xBuddy box.
-  Plug the filament sensor cable into the first slot labeled **EXT** on the xBuddy Extension board.

## KROK 69 Haribo time!

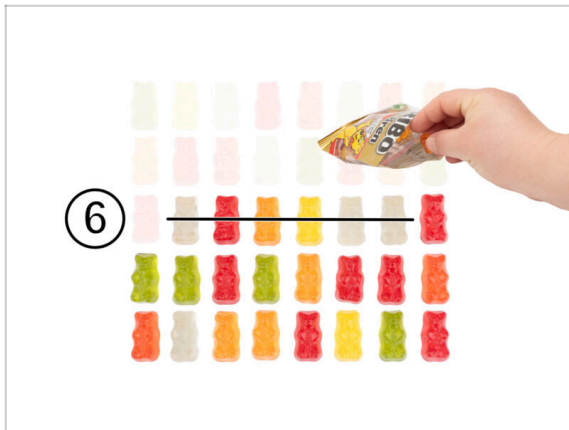

- Great job so far! Another dose of sugar is required.
- Zjedz sześć żelków.

## KROK 70 Done



- Congratulations!** You have just assembled the INDX Toolhead and the side filament sensors.
- Przejdźmy do kolejnego rozdziału.

## 5. Uchwyty szpuli i doki narzędzi



## KROK 1 Narzędzia niezbędne w tym rozdziale

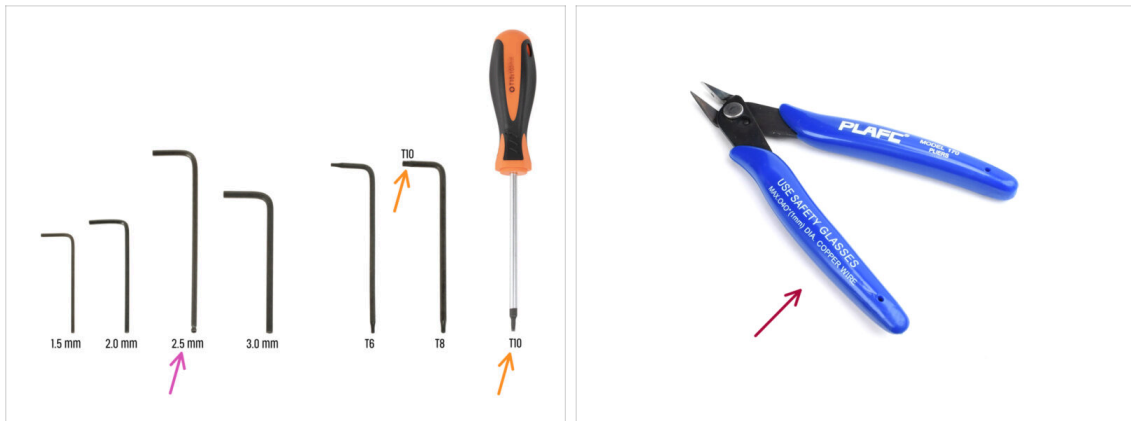

Do tego rozdziału przygotuj:

- 2.5mm Allen key
- T10 key / screwdriver
- Flush cutters - an optional tool, recommended to use for cutting the zip ties. It can be purchased from our e-shop [prusa3d.com](https://prusa3d.com).

## KROK 2 Side handle: parts preparation

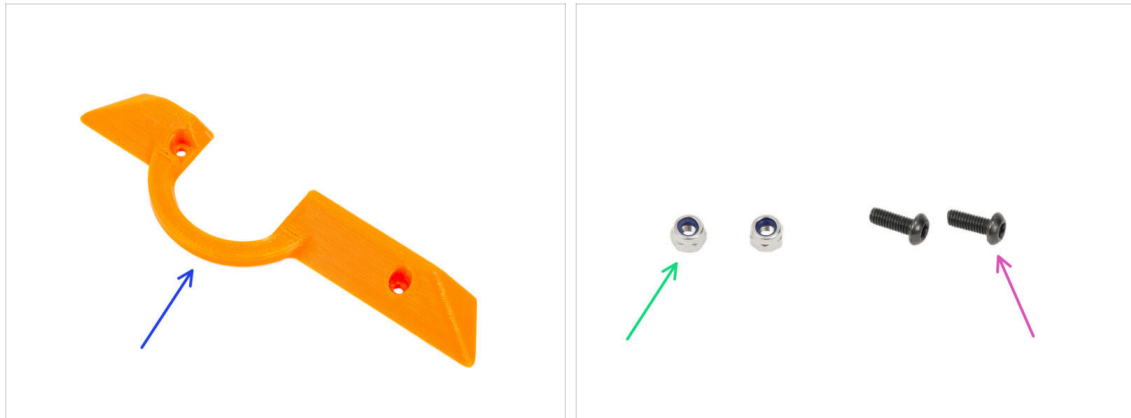

Do kolejnych etapów przygotuj:

- INDX-C1-Side-handle-right (1x)
- M3nN nut (2x) *found in the Fasteners 1/2 bag*
- M3x8T screw (2x) *found in the Fasteners 2/2 bag*

### KROK 3 Installing the side handle



- ◆ Insert two M3x8rT screw into the Side-handle-right.
- ◆ Align the Side-handle-right with the holes in the right side panel and place it in position.
- ◆ From inside the printer, place M3nN nuts onto the screws and hold them with the universal tool.
- ◆ Firmly tighten the screws from the outside.

### KROK 4 Dock fan cable: parts preparation

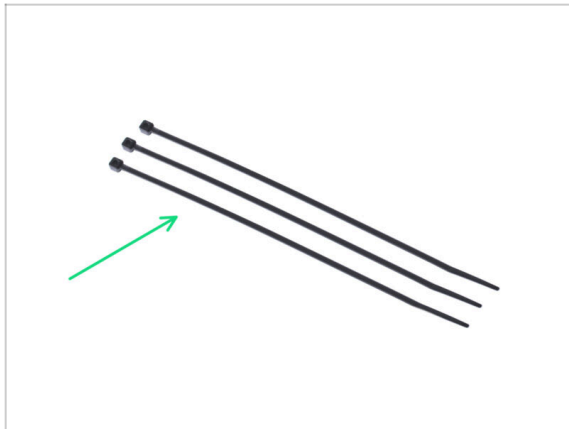

- ◆ Do kolejnych etapów przygotuj:
- ◆ Zip tie (3x)

## KROK 5 Dock fan head cable



- ⓘ We recommend removing the Bowden-guide to make the zip tie insertion easier.
- 🟡 Remove the M3x10 screw that secures the Bowden-guide part.
- 🟢 Remove the Bowden-guide.
- 🟠 Locate the three pairs of holes on the right side of the printer. We will attach the zip ties through these.
- 🟢 Bend the end of each zip tie as shown in the picture.

## KROK 6 Securing the zip ties I.

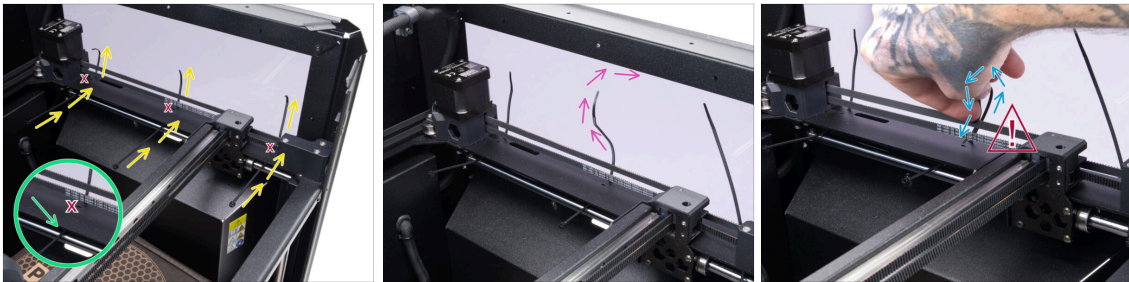

- 🔴 Do not push the zip tie through the inner hole!
  - 🟢 Ensure that the zip tie goes in **above** the smooth rod.
  - 🟡 Thread each zip tie through the **outer** hole.
  - 🟡 Bend the zip tie in the opposite direction.
  - 🟢 Insert the zip tie into the inner hole as shown in the photo. Do not loop the zip tie around the belts.
- ⚠️ **Make sure that the zip tie is NOT looped around the belts!**

## KROK 7 Securing the zip ties II.

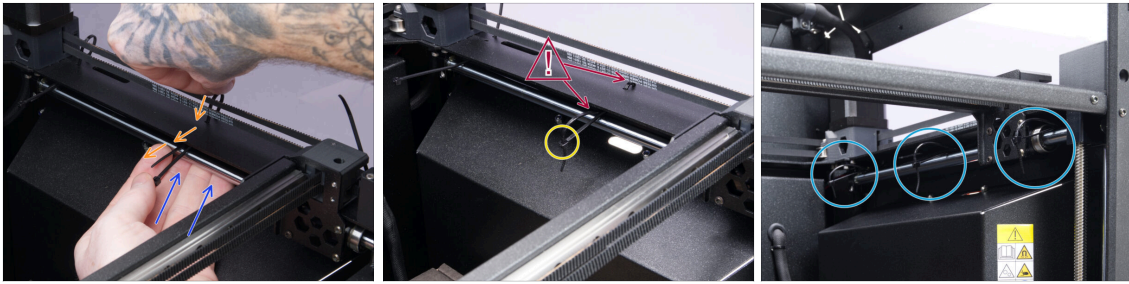

- ◆ Use your fingers from below to guide the zip tie out **above the smooth rod**.
- ◆ Push the zip tie into the inner hole. **Ensure that the zip tie is behind the belts**, not looped around them!
- ⚠ Check again that the **zip tie is not looped around the belts or the smooth rod**.
- ◆ Connect the zip tie.
- ◆ Secure all three zip ties in the same way.

## KROK 8 Attaching the dock fan cable



- ⓘ The dock fan cable connector is the remaining part of the head cable.
- ◆ Insert the Dock fan cable connector through the lower oval opening on the left side of the rear panel.
- ◆ Push the cable inside.
- ◆ Inside the printer, gently pull the dock fan cable as shown in the photo.

## KROK 9 Leading the dock fan cable I.

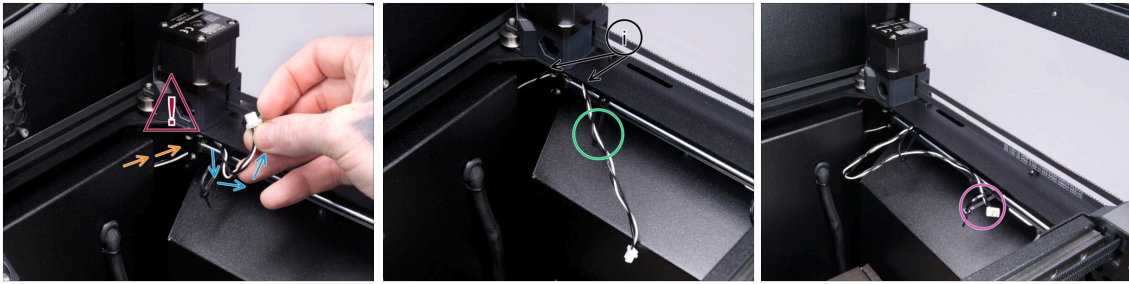

- Lead the dock fan cable **behind the rod holder**.
- ⚠ **The dock fan cable has to be led behind the rod holder! Pay extra attention to ensure that the cable is threaded around the rod holder exactly as shown in the photos.**
- Lead the cable out from behind the rod holder. The cable must come out **above the smooth rod**.
- Lead the dock fan cable through the back zip tie.
- ⓘ Check again that the cable is led correctly behind the rod holder and above the smooth rod.
- Lead the dock fan cable through the middle zip tie.

## KROK 10 Leading the dock fan cable II.

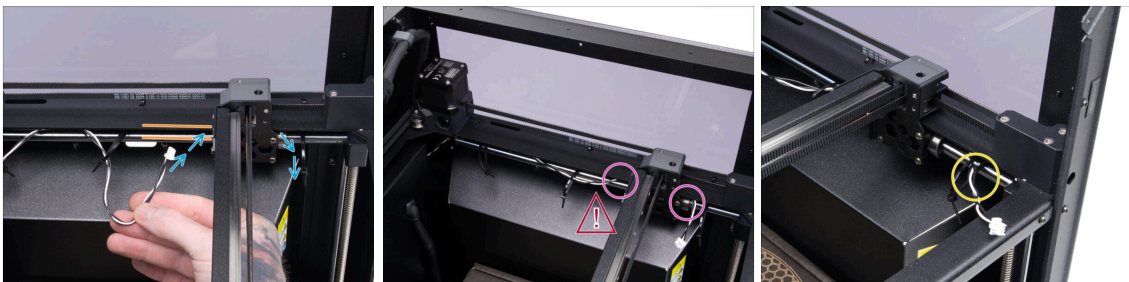

- Insert the dock fan cable and lead it behind the linear holder.
- The cable has to be inserted between the smooth rod and the printer's profile.
- ⚠ **Ensure the cable does not wrap around the smooth rod and that it is inserted **above the smooth rod**.**
- Pull the cable out on the other side above the smooth rod, as shown in the photo.
- Thread the cable through the front zip tie.

## KROK 11 Securing the dock fan cable

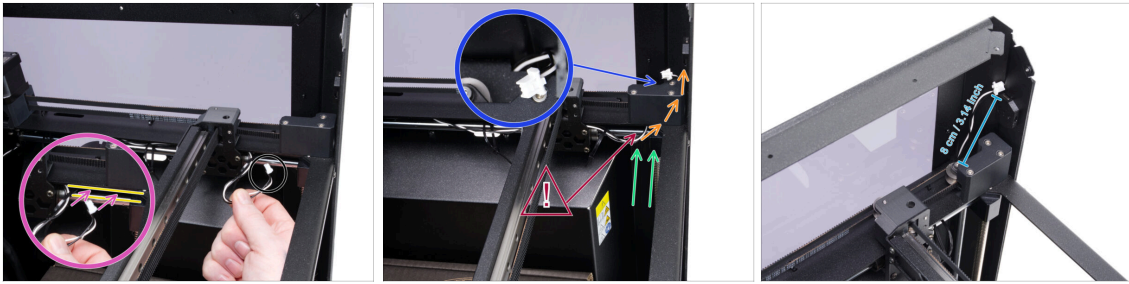

- Gently bend the dock fan cable near the connector.
- Insert the cable between the side profile and the smooth rod.
  - The cable must be inserted above the smooth rod. Ensure it is not led under or around the smooth rod.
- Lead the dock fan cable through the opening between the core XY and the printer's frame.
- Use your finger to help you guide the cable from below through the opening in the corner.
- ⚠ Double-check that the **cable is threaded correctly** above the smooth rod and under the printer's side profile.
- Carefully pull the cable out and leave it protruding for 8 cm/3.14 inches.

## KROK 12 Tightening the zip ties I.

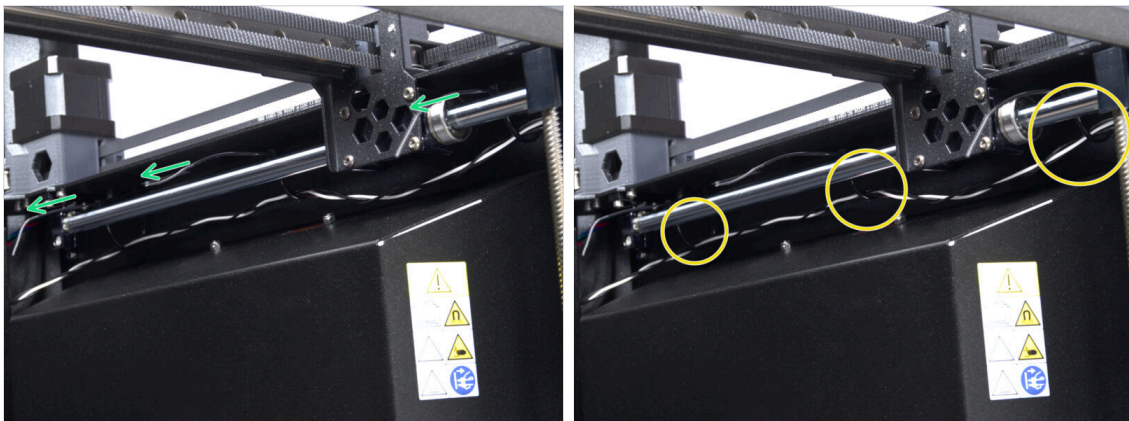

- Pull on the zip tie to tighten it so the head and pawl move inward between the profile and the smooth rod.
- Ensure one last time that the cable is threaded through all three zipties and that it is positioned exactly as shown in the photo

## KROK 13 Tightening the zip ties II.



- ❗ Tightening the zip ties is tricky and requires needle-nose pliers. Be very careful not to damage the printer or the cable.
- 🔵 Before tightening the zipties, ensure that the dock fan cable is in position and protruding 8 cm/3.14 inches.
- 🟡 Use needle-nose pliers to carefully grab the zip tie on top and pull it up, so it can be properly tightened in the next step.
- 🟢 While pulling on the zip tie, use your fingers to push it upwards from below.
- 🟠 Keep pushing on the zip tie from below and start tightening it.
- 🟠 Very carefully insert the pliers and squeeze the head of the zip tie. Firmly pull on the zip tie to tighten it completely.
- ⬛ Tighten the remaining zip ties using the same process.  
Cut off the excess zip ties. Ensure they are fully tightened and that the zip ties do not prevent movement of the Y axis.

## KROK 14 Nozzle cleaner: parts preparation I.

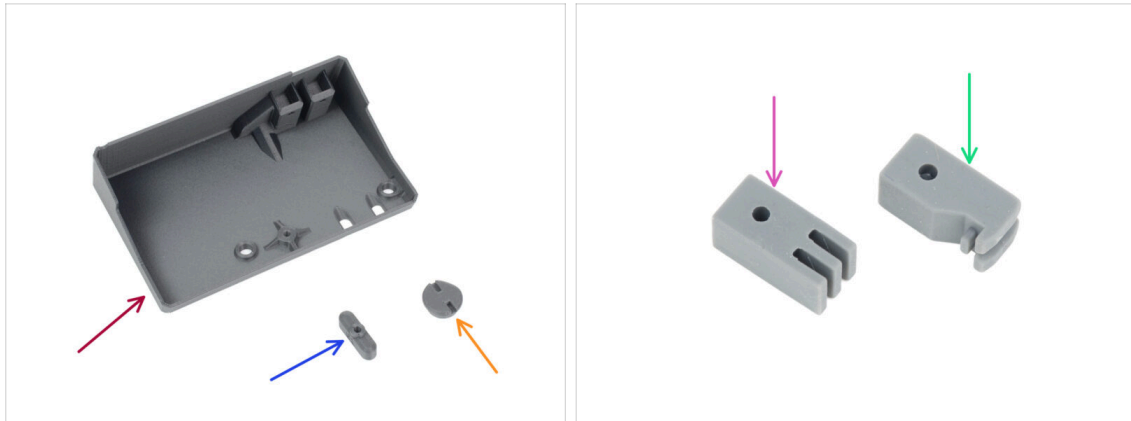

### Do kolejnych etapów przygotuj:

- INDX-C1-Wiper-base (1x) *found in the Wiper bag*
  - INDX-C1-Wiper-lock (1x) *found in the Wiper bag*
  - INDX-C1-Wiper-adjuster (1x) *found in the Wiper bag*
  - Silicone wiper (1x) *found in the Fasteners 2/2 bag*
  - Silicone priming block (1x) *found in the Fasteners 2/2 bag*
- i** Nozzle cleaner is the name for the whole assembly.

## KROK 15 Nozzle cleaner: parts preparation II.

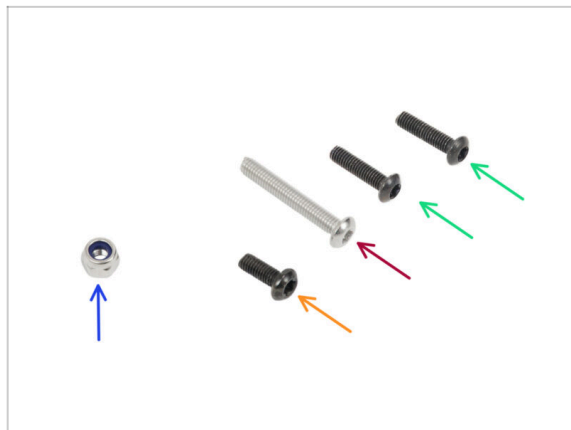

- M3N nut (1x) *found in the Fasteners 1/2 bag*
- M3x8rT screw (1x) *found in the Fasteners 2/2 bag*
- M3x20rT screw (1x) *found in the Fasteners 2/2 bag*
- M3x12rT screw (2x) *found in the Fasteners 2/2 bag*

## KROK 16 Assembling the Wiper-lock



- Push the M3x20rT screw through the Wiper-lock.
- Insert the Wiper-lock with the screw into the Wiper-base.

## KROK 17 Securing the Wiper-lock



- From the opposite side, place the M3nN nut onto the screw and tighten it using the universal wrench.
- Loosen it by a quarter to half a turn so the Wiper-lock can move.
- Set the Wiper-lock **according to the markings** on the Wiper-base.
- i** If the Wiper-lock moves on its own, slightly tighten the screw.

## KROK 18 Installing the Wiper-adjuster



- ◆ Insert the M3x8rT screw through the channel in the Wiper-base.
- ◆ Align the hole in the Wipe-adjuster with the screw.
- ◆ Secure the Wiper-adjuster in the slots using the universal wrench and tighten the M3x8rT screw with a T10 screwdriver.
- ◆ Note the irregular shape of the Wiper-adjuster. Use the universal wrench to position it so that its **flattened side faces downward**.

## KROK 19 Inserting the wiper blocks



- ◆ Insert the silicone priming block into the front slot (left in the photo). Ensure the part is oriented correctly.
- ◆ Insert the silicone wiper into the rear slot (right in the photo).
- ◆ Check the correct position of the silicone wiper. The wiper is sloped; make sure that the sloped side points inside the Wiper-base.
- ⓘ *Pro tip:* Lightly wipe the wiper blocks with IPA (Isopropyl alcohol) before inserting and securing them in the wiper base. This will make the insertion a lot easier.
- ◆ Secure the silicone wiper and priming block with two M3x12rT screws.
  - ◆ Guide the T10 key or screwdriver through the dedicated openings in the Wiper-base for better access.
- ⚠ **Double-check that the wiper is inserted correctly, with the sloped side pointing inside the Wiper-base.**

## KROK 20 Installing the nozzle cleaner

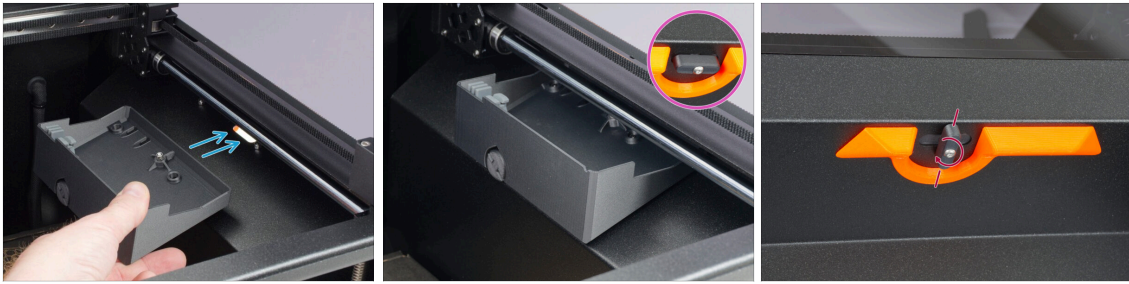

- ◆ From inside the printer, place the nozzle cleaner assembly on the right side panel.
- ◆ The Wiper-lock must fit **into the oval opening**.
- ◆ From the outside, check that the Wiper-lock extends into the handle area.
- ◆ Rotate the Wiper-lock by 90° to secure the wiper assembly in place.

## KROK 21 Electronics covers: parts preparation

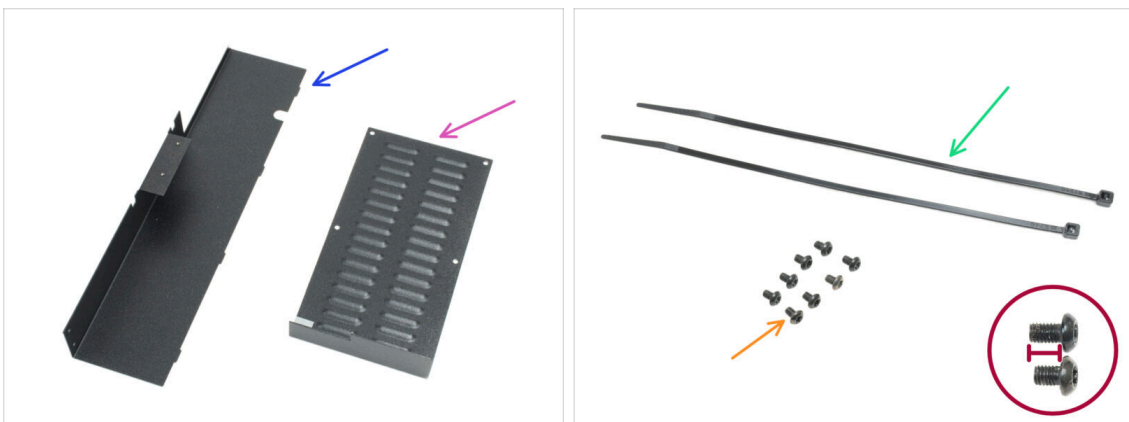

### ◆ Do kolejnych etapów przygotuj:

- ◆ Sheet metal back cover (1x)
- ◆ xBuddy cover (1x)
- ◆ Zip tie (2x)
- ◆ M3x4rT screw (8x) *you removed earlier*

⚠ Be careful **not to mix up the M3x4rT and M3x5rT screws**, which you will need later for the door assembly.

## KROK 22 Securing the cables

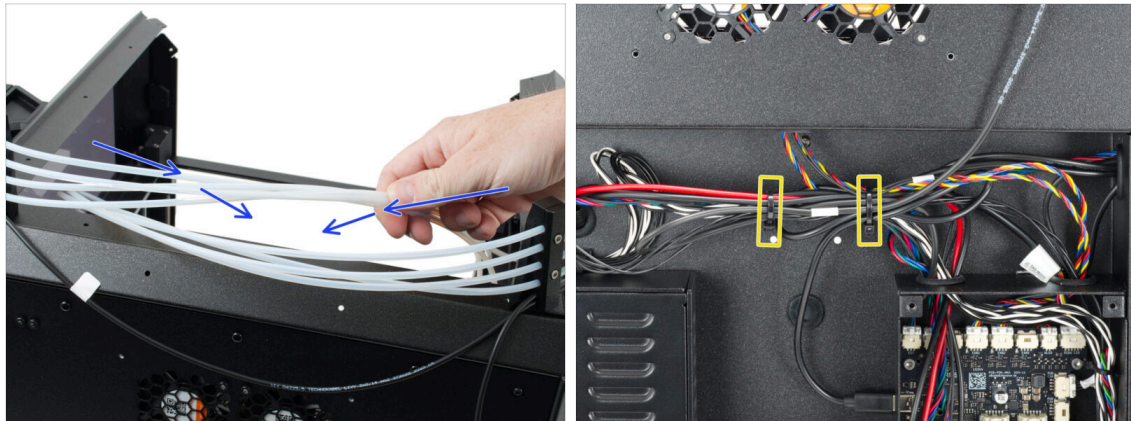

- ◆ Insert all loose ends of the PTFE tubes inside the printer.
- ◆ Form loops from the excess cables as shown in the picture.
- ◆ Bundle the cables together and secure them with two zip ties.

## KROK 23 Wiring check

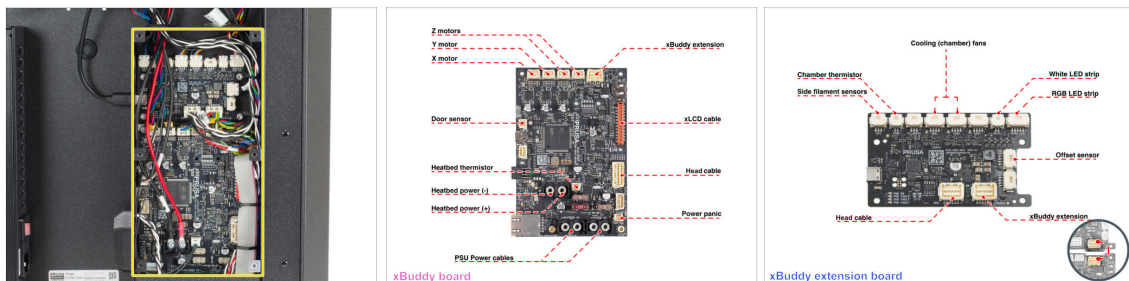

- ◆ Before closing the electronics cover, check that everything is correctly connected.
- ◆ Porównaj swoje podłączenie elektroniki z ilustracją.
- ◆ **The electronics compartment is divided into two boards:**
  - ◆ xBuddy board
  - ◆ xBuddy extension board

## KROK 24 Montaż pokrywy obudowy xBuddy



✿ Ostrożnie zakryj obudowę xBuddy, wsuwając najpierw wygiętą część pokrywy.

⚠ **Avoid pinching the cables and make sure to insert the cover perpendicular to the xBuddyboard.**

● Przymocuj pokrywę obudowy xBuddy sześcioma śrubami M3x4rT.

## KROK 25 Montaż tylnej pokrywy



◆ Wyrównaj tylną maskownicę tak, aby przewody zostały ułożone na „tacce”.

◆ Umieść tylną maskownicę przewodów we wgłębieniu. Dociśnij do drukarki, a następnie przesunij w górę, aby ją zatrzasać.

◆ Maskownica ma cztery zaczepy, które muszą wejść w szczeliny na korpusie drukarki.

◆ Insert the filament sensor cable to the cutout.

◆ If you have a USB-C cable for the Buddy3D camera installed, route it through the lower cutout.

● Przymocuj tylną pokrywę dwoma śrubami M3x4rT od wewnątrz drukarki.

## KROK 26 Bottom puck holders: parts preparation

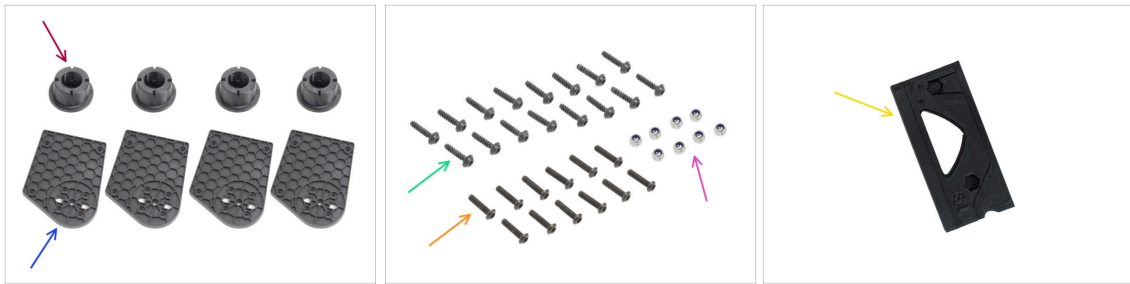

### Do kolejnych etapów przygotuj:

- Puck-universal (4x) *found in the Pucks bag*
- Puck holder bottom (4x) *found in the Puck Holders bag*
- 3x12sT screw (16x) *found in the Fasteners 2/2 bag*
- M3x12rT screw (12x) *found in the Fasteners 2/2 bag*
- M3nN nut (8x) *found in the Fasteners 1/2 bag*
- Spoolholder-assembly-tool (1x) *found in the Position Tools INDX bag*

## KROK 27 Assembling the bottom puck holders



- Align the Puck holder bottom with the holes in the Puck-universal part.
- Join the parts using four 3x12sT screws.
- Install another Puck holder bottom onto the next Puck-universal part, but in a **mirrored orientation**.
- Assemble the **second pair** of the Puck holder bottom parts using the same procedure.

## KROK 28 Removing the screws - right

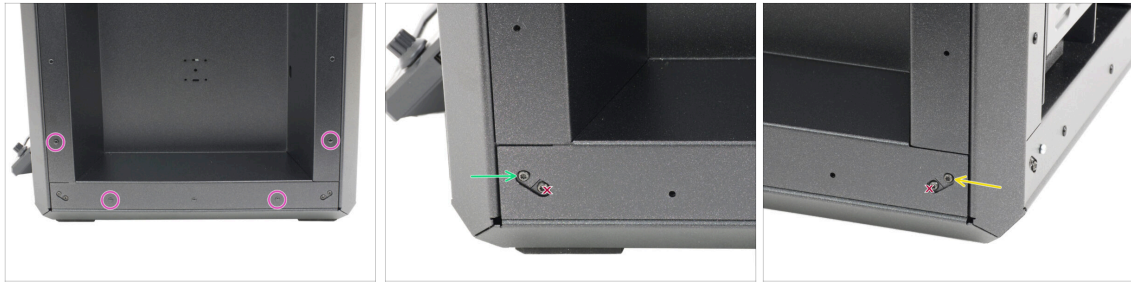

- ◆ On the right side of the printer, remove the two marked nylon rivets from each lower corner.
- ◆ Remove the **upper** M3x4rT screw from the lower left corner of the side panel.
- ◆ Remove the **upper** M3x4rT screw from the lower right corner of the side panel.

## KROK 29 Mounting the bottom puck holders - right



- ◆ Place one Puck holder bottom in the rear corner on the right side. Ensure that the orientation is correct.
- ◆ Secure it with the M3x12rT screw.
- ◆ Place one Puck holder bottom in the front corner on the right side. Ensure that the orientation is correct.
- ◆ Secure it with the M3x12rT screw.

## KROK 30 Securing the front Puck-holder bottom - right I.



- We use an orange Spoolholder-assembly-tool in this guide for clarity. Your tool is black.
- Insert one M3nN nut into the Spoolholder-assembly-tool as shown in the photo.
- ⓘ **The side of the nut without the rubber must point outward from the Spoolholder-assembly-tool.**
- Double-check that the nut is inserted in the same hole closer to the top edge, with the **arrow pointing RIGHT next to it.**
- Insert the Spoolholder-assembly-tool **into the printer**, with the M3nN nut facing the side cover.
- ⚠ **Note the orientation of the Spoolholder-assembly-tool in the photo, where it is inserted into the printer.**
- "Hook" the ridge in the assembly tool onto the side of the metal profile.
- The M3nN nut is now in the right position and height for the puck holder bottom to be attached to the printer with the M3x12rT screw.

## KROK 31 Securing the front Puck-holder bottom - right II.



- Hold the Spoolholder-assembly-tool in position with your hand on the inside of the printer.
- Use the Torx key to tighten the M3x12rT screw.
- The front right puck holder is now attached to the printer.

## KROK 32 Securing the rear Puck-holder bottom - right I.



- Insert one M3nN nut into the Spoolholder-assembly-tool as shown in the photo.
- ⓘ **The side of the nut without the rubber must point outward from the Spoolholder-assembly-tool.**
- Double-check that the nut is inserted in the same hole closer to the top edge, with the **arrow pointing UP** next to it.
- Insert the Spoolholder-assembly-tool **into the back of the printer**, with the M3nN nut facing the side cover.
- ⚠ **Note the orientation of the Spoolholder-assembly-tool in the photo, where it is inserted into the printer.**
- "Hook" the ridge in the assembly tool onto the side of the metal profile.
- ⓘ The M3nN nut is now in the right position and height for the puck holder bottom to be attached to the printer with the M3x12rT screw.

## KROK 33 Securing the rear Puck-holder bottom - right II.



- Hold the Spoolholder-assembly-tool in position with your hand on the inside of the printer.
- Use the Torx key to tighten the M3x12rT screw.
- The rear right puck holder is now attached to the printer.

### KROK 34 Removing the screws - left

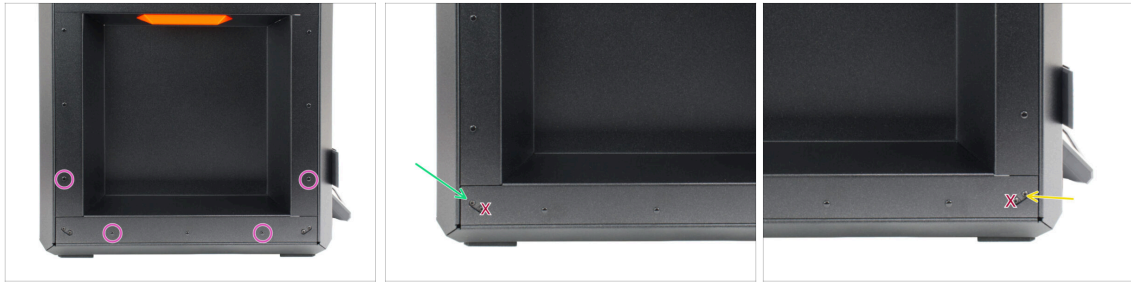

- On the left side of the printer, remove the two marked nylon rivets from each lower corner.
- Remove the **upper** M3x4rT screw from the lower left corner of the side panel.
- Remove the **upper** M3x4rT screw from the lower right corner of the side panel.

### KROK 35 Mounting the bottom puck holders - left



- Place one Puck holder bottom in the rear corner on the left side. Ensure that the orientation is correct.
- Secure it with the M3x12rT screw.
- Place one Puck holder bottom in the front corner on the left side. Ensure that the orientation is correct.
- Secure it with the M3x12rT screw.

## KROK 36 Securing the front Puck-holder bottom - left I.



- Insert one M3nN nut into the Spoolholder-assembly-tool as shown in the photo.
- **The side of the nut without the rubber must point outward from the Spoolholder-assembly-tool.**
- Double-check that the nut is inserted in the same hole closer to the top edge, with the **arrow pointing UP next to it.**
- Insert the Spoolholder-assembly-tool **into the printer**, with the M3nN nut facing the side cover.
- ⚠ **Note the orientation of the Spoolholder-assembly-tool in the photo, where it is inserted into the printer.**
- "Hook" the ridge in the assembly tool onto the side of the metal profile.
- ⓘ The M3nN nut is now in the right position and height for the puck holder bottom to be attached to the printer with the M3x12rT screw.

## KROK 37 Securing the front Puck-holder bottom - left II.

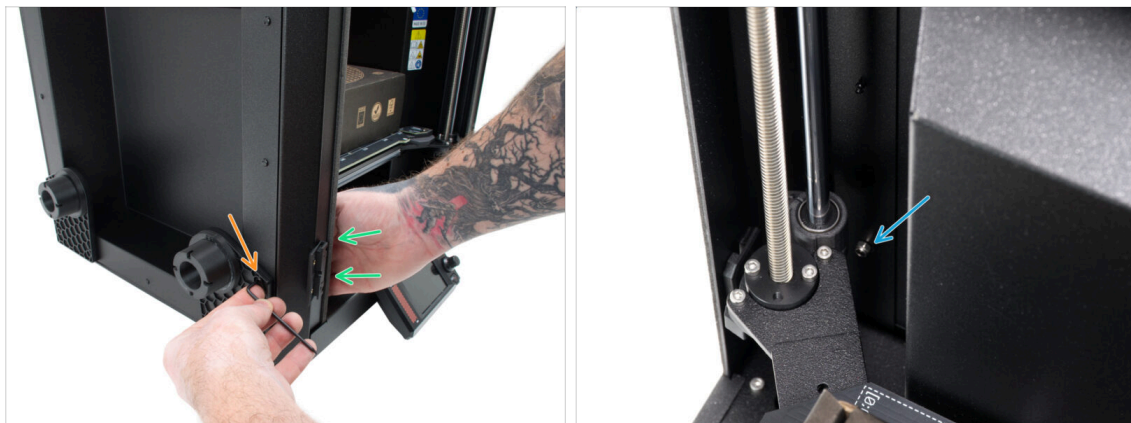

- Hold the Spoolholder-assembly-tool in position with your hand on the inside of the printer.
- Use the Torx key to tighten the M3x12rT screw.
- The front left puck holder is now attached to the printer.

## KROK 38 Securing the rear Puck-holder bottom - left I.



- Insert one M3nN nut into the Spoolholder-assembly-tool as shown in the photo.
- **The side of the nut without the rubber must point outward from the Spoolholder-assembly-tool.**
- Double-check that the nut is inserted in the same hole closer to the top edge, with the **arrow pointing RIGHT next to it.**
- Insert the Spoolholder-assembly-tool **into the printer**, with the M3nN nut facing the side cover.
- ⚠ **Note the orientation of the Spoolholder-assembly-tool in the photo, where it is inserted into the printer.**
- "Hook" the ridge in the assembly tool onto the side of the metal profile.
- ⓘ The M3nN nut is now in the right position and height for the puck holder bottom to be attached to the printer with the M3x12rT screw.

## KROK 39 Securing the rear Puck-holder bottom - left II.



- Hold the Spoolholder-assembly-tool in position with your hand on the inside of the printer.
- Use the Torx key to tighten the M3x12rT screw.
- The rear left puck holder is now attached to the printer.

## KROK 40 Tilting the printer



- ❗ To gain access to the bottom of the printer, it has to be placed on its back. Use the Prusament box that is protecting the heatbed.
- Remove the Prusament box from the heatbed and place it behind the printer.
- Move the toolhead to the back of the printer.
- Place all the PTFE tubes inside the printer.
- Place the box behind the printer and slowly and carefully lay the printer down so it can lean on the box.
- ⚠ **Ensure that the printer is stable and that it can not slide or fall when tilted. We recommend asking someone to hold the printer while it rests on the box to ensure your safety.**
- Ensure that the filament sensor cables are not pinched.

## KROK 41 Finishing the rear puck holder bottom - left I.



- Insert one M3nN nut into the Spoolholder-assembly-tool as shown in the photo.
  - **The side of the nut without the rubber must point outward from the Spoolholder-assembly-tool.**
  - Double-check that the nut is inserted in the same hole closer to the top edge, with the **arrow pointing RIGHT** next to it.
- Use the highlighted ridge in the Spoolholder-assembly-tool to position the tool correctly against the printer profile.
- Insert the Spoolholder-assembly-tool with the M3nN nut inside the bottom of the printer, with **the nut facing the side cover.**
- Check that the Spoolholder-assembly-tool is placed correctly. The bottom profile of the printer has to align with the ridge in the tool.
- ⓘ The M3nN nut is now in the right position and height for the puck holder bottom to be attached to the printer with the M3x12rT screw.

## KROK 42 Finishing the rear puck holder bottom - left II.



- Hold the Spoolholder-assembly-tool in position with your hand on the inside of the printer.
- Use the Torx key to tighten the M3x12rT screw.
- The rear left puck holder is now completely attached to the printer.

## KROK 43 Finishing the front puck holder bottom - left I.



- Insert one M3nN nut into the Spoolholder-assembly-tool as shown in the photo.
- ⓘ **The side of the nut without the rubber must point outward from the Spoolholder-assembly-tool.**
- Double-check that the nut is inserted in the same hole closer to the top edge, with **the arrow pointing UP next to it.**
- Insert the Spoolholder-assembly-tool under the front of the printer, with the M3nN nut facing the side cover.
- "Hook" the ridge in the assembly tool onto the side of the metal profile and gently push the tool upwards.
- ⓘ The M3nN nuts are now in the right position and height for the puck holder top to be attached to the printer with two M3x12rT screws.

## KROK 44 Finishing the front puck holder bottom - left II.



- Hold the Spoolholder-assembly-tool in position with your hand on the inside of the bottom of the printer.
- Use the Torx key to tighten the M3x12rT screw.
- The front left puck holder is now completely attached to the printer.

## KROK 45 Finishing the rear puck holder bottom - right I.

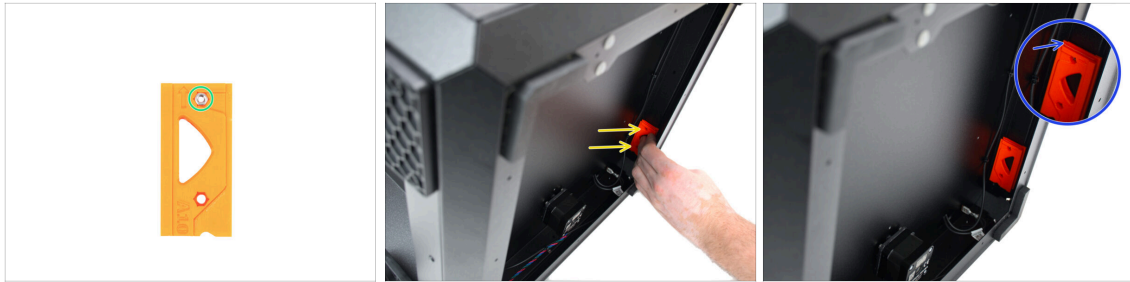

- ◆ Insert one M3nN nut into the Spoolholder-assembly-tool as shown in the photo.
  - ◆ **The side of the nut without the rubber must point outward from the Spoolholder-assembly-tool.**
  - ◆ Double-check that the nut is inserted in the same hole closer to the top edge, with the **arrow pointing UP next to it.**
- ◆ Insert the Spoolholder-assembly-tool under the front of the printer, with the M3nN nut facing the side cover.
- ◆ "Hook" the ridge in the assembly tool onto the side of the metal profile and gently push the tool upwards.
- ⓘ The M3nN nuts are now in the right position and height for the puck holder top to be attached to the printer with two M3x12rT screws.

## KROK 46 Finishing the rear puck holder bottom - right II.



- ◆ Hold the Spoolholder-assembly-tool in position with your hand on the inside of the bottom of the printer.
- ◆ Use the Torx key to tighten the M3x12rT screw.
- ◆ The rear right puck holder is now completely attached to the printer.

## KROK 47 Finishing the front puck holder bottom - right I.



- ◆ Insert one M3nN nut into the Spoolholder-assembly-tool as shown in the photo.
  - i **The side of the nut without the rubber must point outward from the Spoolholder-assembly-tool.**
    - ◆ Double-check that the nut is inserted in the same hole closer to the top edge, with the **arrow pointing RIGHT next to it.**
  - ◆ Insert the Spoolholder-assembly-tool under the front of the printer, with the M3nN nut facing the side cover.
  - ⚠ **Note the orientation of the Spoolholder-assembly-tool in the photo, where it is inserted into the printer.**
  - ◆ "Hook" the ridge in the assembly tool onto the side of the metal profile and gently push the tool upwards.
  - i The M3nN nuts are now in the right position and height for the puck holder top to be attached to the printer with two M3x12rT screws.

## KROK 48 Finishing the front puck holder bottom - right II.



- ◆ Hold the Spoolholder-assembly-tool in position with your hand on the inside of the bottom of the printer.
  - ◆ Use the Torx key to tighten the M3x12rT screw.
  - ◆ The front right puck holder is now completely attached to the printer.
  - ◆ Carefully tilt the printer back on its feet.

## KROK 49 Top puck holders: parts preparation

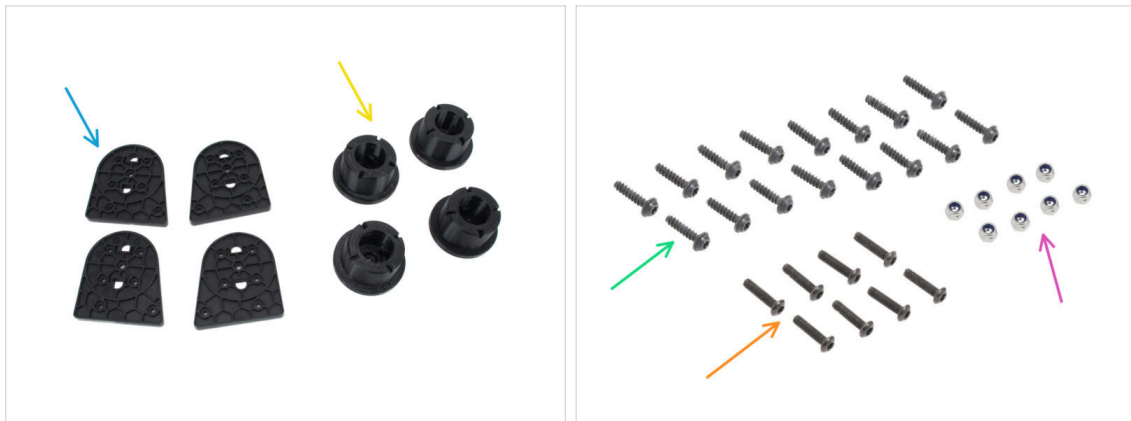

- Puck holder top (4x) found in the Puck Holders bag
- Puck-universal (4x) found in the Pucks bag
- 3x12sT screw (16x) found in the Fasteners 2/2 bag
- M3x12rT screw (8x) found in the Fasteners 2/2 bag
- M3nN nut (8x) found in the Fasteners 1/2 bag

## KROK 50 Assembling the puck holder top



- Align the Puck holder top with the holes in the Puck-universal part.
- Join the parts using four 3x12sT screws.
- Install another Puck holder top onto the next Puck-universal part, but **in a mirrored orientation**.
- Assemble the **second pair** of the Puck holder tops parts using the same procedure.

## KROK 51 Removing the nylon rivets - right

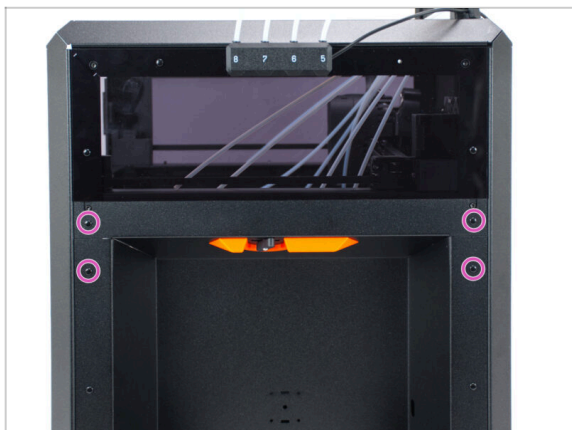

- On the right side of the printer, remove the two marked nylon rivets from each top corner.

## KROK 52 Mounting the front puck holder top - right

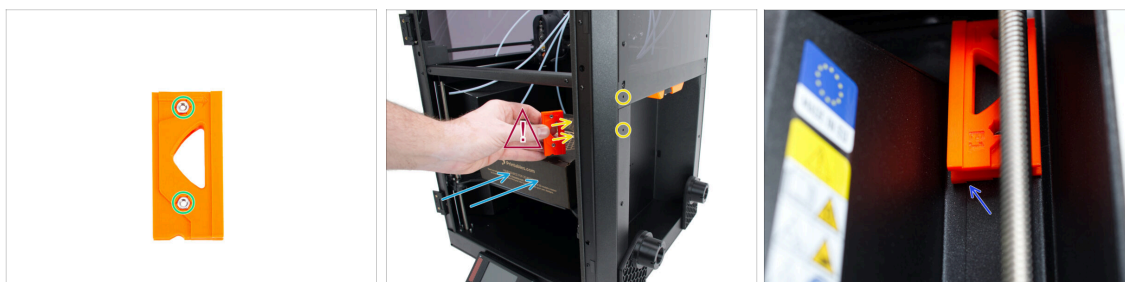

- Insert two M3nN nuts into the Spoolholder-assembly-tool as shown in the photo.
- Place the filament box back onto the heatbed.
- i** The side of the nuts without the rubber must point outward from the Spoolholder-assembly-tool.
- i** The side of the nut without the rubber must point outward from the Spoolholder-assembly-tool.
- !** Double-check that the nuts are inserted on the correct side of the tool. Note the hole closer to the top edge, with the **arrow pointing RIGHT next to it**.
- Insert the Spoolholder-assembly-tool into the printer, with the M3nN nuts facing the side cover.
- "Hook" the ridge in the assembly tool onto the side of the metal profile and gently push the tool upwards.
- i** The M3nN nuts are now in the right position and height for the puck holder top to be attached to the printer with two M3x12rT screws.

## KROK 53 Securing the front puck holder top - right



- Hold the Spoolholder-assembly-tool in position with your hand on the inside of the printer.
- Place the front puck holder top on the printer. Note the correct position in the photo.
- ⓘ Insert the M3x12rT screw into the front puck holder top before attaching it to make it easier to connect the screw with the nut. Using only one hand is a bit fiddly, but manageable.
- Use the Torx key to tighten the top M3x12rT screw.
- Use the Torx key to tighten the lower M3x12rT screw.
- The front right puck holder is now attached to the printer.

## KROK 54 Mounting the rear puck holder top - right

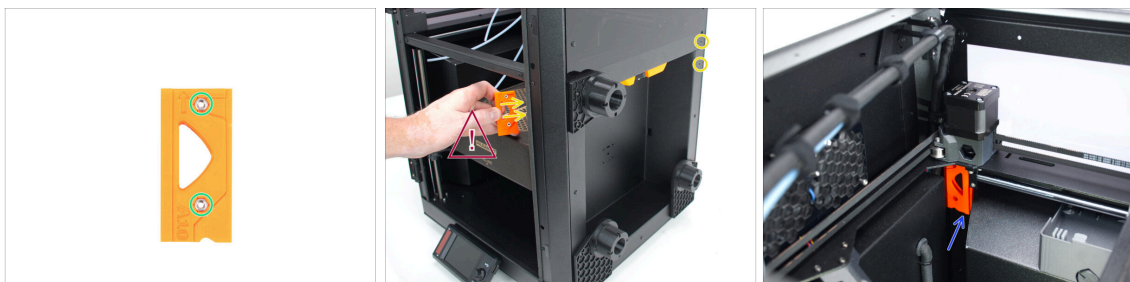

- Insert two M3nN nuts into the Spoolholder-assembly-tool as shown in the photo.
- ⓘ **The side of the nut without the rubber must point outward from the Spoolholder-assembly-tool.**
- Double-check that the nuts are inserted on the correct side of the tool. Note the hole closer to the top edge, with the **arrow pointing UP** next to it.
- Insert the Spoolholder-assembly-tool **into the printer**, with the M3nN nut facing the side cover.
- ⚠ **Note the orientation of the Spoolholder-assembly-tool in the photo, where it is inserted into the printer.**
- "Hook" the ridge in the assembly tool onto the side of the metal profile and gently push the tool upwards.
- ⓘ The M3nN nuts are now in the right position and height for the puck holder top to be attached to the printer with two M3x12rT screws.

## KROK 55 Securing the rear puck holder top - right



- ◆ Hold the Spoolholder-assembly-tool in position with your hand on the inside of the printer.
- ◆ Place the rear puck holder top on the printer. Note the correct position in the photos.
- 📌 Insert the M3x12rT screw into the front puck holder top before attaching it. This will make it easier to connect the screw with the nut. Using only one hand is a bit fiddly, but manageable.
- ◆ Use the Torx key to tighten the top M3x12rT screw.
- ◆ Use the Torx key to tighten the lower M3x12rT screw.
- ◆ The rear left puck holder is now attached to the printer.

## KROK 56 Removing the nylon rivets - left



- ◆ On the left side of the printer, remove the two marked nylon rivets from each top corner.

## KROK 57 Mounting the front puck holder top - left

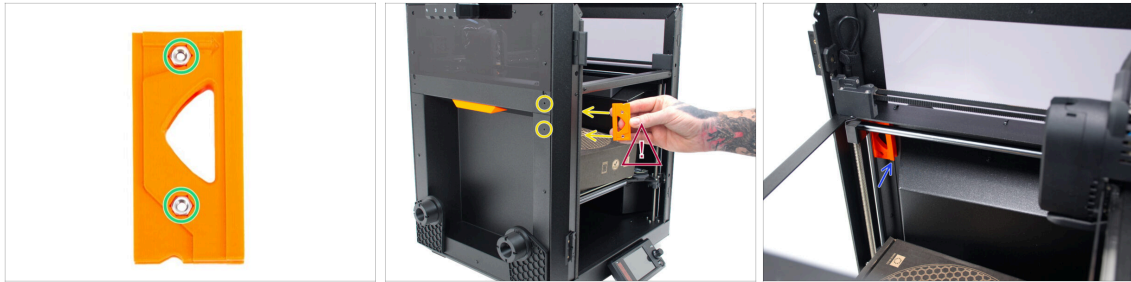

- Insert two M3nN nuts into the Spoolholder-assembly-tool as shown in the photo.
  - Double-check that the nut is inserted in the same hole closer to the top edge, with the **arrow pointing RIGHT next to it**.
- Insert the Spoolholder-assembly-tool **into the printer**, with the M3nN nuts facing the side cover.
- ⚠ **Note the orientation of the Spoolholder-assembly-tool in the photo, where it is inserted into the printer.**
- "Hook" the ridge in the assembly tool onto the side of the metal profile and gently push the tool upwards.
- ⓘ The M3nN nuts are now in the right position and height for the puck holder top to be attached to the printer with two M3x12rT screws.

## KROK 58 Securing the front puck holder top - left



- Hold the Spoolholder-assembly-tool in position with your hand on the inside of the printer.
- Place the front puck holder top on the printer. Note the correct position in the photo.
- ⓘ Insert the M3x12rT screw into the front puck holder top before attaching it to make it easier to connect the screw with the nut. Using only one hand is a bit fiddly, but manageable.
- Use the Torx key to tighten the top M3x12rT screw.
- Use the Torx key to tighten the lower M3x12rT screw.
- The front left puck holder is now attached to the printer.

## KROK 59 Mounting the rear puck holder top - left

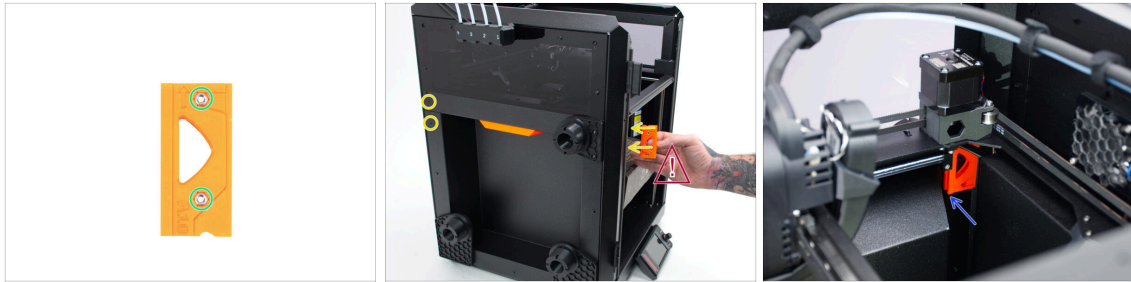

- ◆ Insert two M3nN nuts into the Spoolholder-assembly-tool as shown in the photo.
  - ◆ Double-check that the nut is inserted in the same hole closer to the top edge, with the **arrow pointing UP next to it**.
- ◆ Insert the Spoolholder-assembly-tool **into the printer**, with the M3nN nuts facing the side cover.
- ⚠ **Note the orientation of the Spoolholder-assembly-tool in the photo, where it is inserted into the printer.**
- ◆ "Hook" the ridge in the assembly tool onto the side of the metal profile and gently push the tool upwards.
- ⓘ The M3nN nuts are now in the right position and height for the puck holder top to be attached to the printer with two M3x12rT screws.

## KROK 60 Securing the rear puck holder top - left



- ◆ Hold the Spoolholder-assembly-tool in position with your hand on the inside of the printer.
- ◆ Place the front puck holder top on the printer. Note the correct position in the photo.
- ⓘ Insert the M3x12rT screw into the front puck holder top before attaching it to make it easier to connect the screw with the nut. Using only one hand is a bit fiddly, but manageable.
- ◆ Use the Torx key to tighten the top M3x12rT screw.
- ◆ Use the Torx key to tighten the lower M3x12rT screw.
- ◆ The rear left puck holder is now attached to the printer.

## KROK 61 Dock fan: parts preparation



- Do kolejnych etapów przygotuj:
- Dock-fan-holder (1x) *found in the Tool Dock Fan bag*
- Dock fan blower (1x) *found in the Tool Dock Fan bag*
- INDX FunFan board (1x) *found in the Tool Dock Fan bag*
- M3x25 screw (1x)
- M3nS nut (1x)
- M3x8rT screw (1x)
- M3x35 screw (2x) *found in the Tool Dock Fan bag*

## KROK 62 Assembling the dock fan

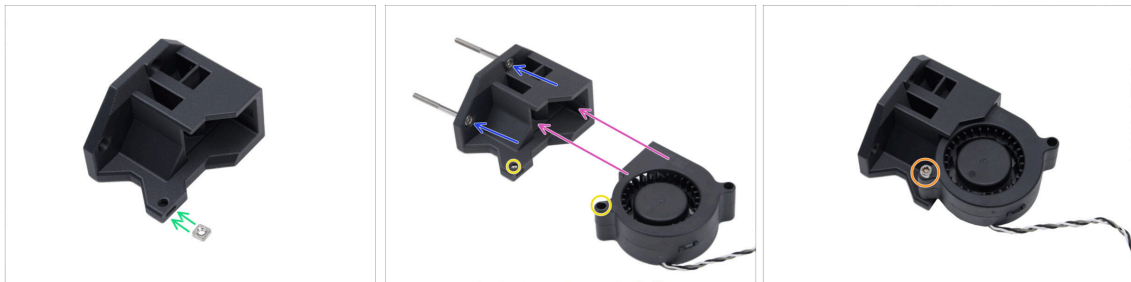

- Insert the M3nS nut into the Dock-fan-holder.
- Insert the two M3x35 screws into the Dock-fan-holder. Do this **before attaching the dock fan**.
- Insert the dock fan. Ensure that the orientation of the dock fan is as shown in the photo.
- The highlighted holes have to align once the dock fan is inserted.
- Secure the dock fan in the Dock-fan-holder with the M3x25 screw.

## KROK 63 Attaching the FunFan board

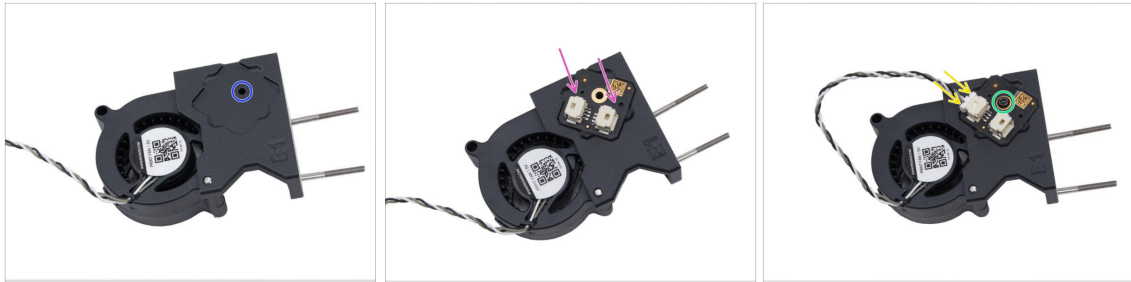

- ◆ Flip the dock fan assembly so that the sticker on the dock fan is visible.
- Note the highlighted area.
- ◆ Place the FunFan board into the ridge in the Dock-fan-holder. Ensure that the hole in the board aligns with the hole in the holder.
- ⓘ Before you touch the electronics, touch any conductive (metal) surface to neutralize the static charge from your hands.
- ◆ Trzymaj płytki tylko za krawędzie, gdy się nimi posługujesz. Nie dotykaj żadnych komponentów na płycie.
- Secure the INDX FunFan board in place with the M3x8rT screw.
- Plug the dock fan cable into the slot that is closer to the fan. Ensure that the safety latch clicks in place.

## KROK 64 Attaching the dock fan

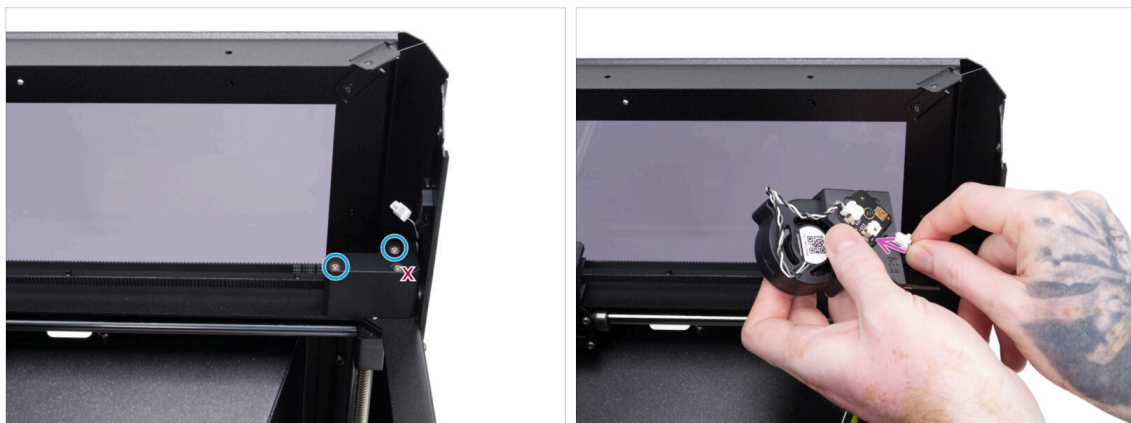

- Remove the two highlighted M3x30 screws from the Belt-tensioner.
- Do not remove the third screw.
- ◆ Plug the dock fan cable connector into the remaining slot on the FunFan board. Make sure that the safety latch clicks in place.
- ⓘ Be careful not to scratch or damage the printer with the two screws protruding from the dock fan assembly.

## KROK 65 Securing the dock fan



- With the dock fan cable plugged in, carefully turn the dock fan assembly.
- Gently lower the dock fan assembly to insert both M3x35 screws into the Belt-tensioner as shown.
- With the dock fan in place, use the 2.5mm Allen key to tighten the two M3x35 screws.

## KROK 66 Haribo time!

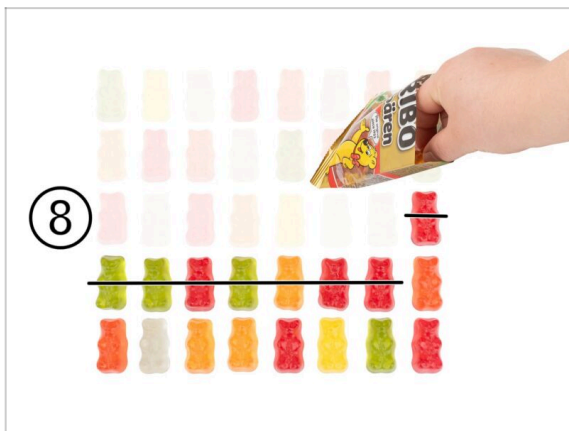

- That was a big one. Reward yourself properly and refill your energy.
- Eat 8 gummy bears.

## KROK 67 Tool holder: parts preparation

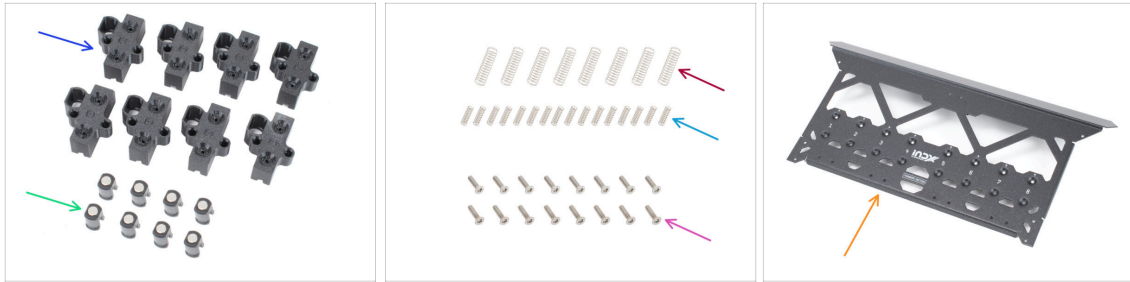

### Do kolejnych etapów przygotuj:

- INDX-Tool-holder (8x) *found in the Tools bag*
- Thimble (8x) *found in Tools bag*
- Spring 0.5 x 8.5 x 30 x 15 (8x) *found in the Fasteners Tools INDX bag*
- Spring 0.63 x 5 x 15 x 11 (16x) *found in the Fasteners Tools INDX bag*
- M3x12cT countersunk screw (16x)
- INDX C1 Front profile (1x) *found in the main box*

## KROK 68 Assembling the tool holder



- Fully thread the M3x12cT screw into both holes of the Tool-holder, then remove the screw.
- i This creates a thread in the part, making the Tool-holder easier to install on the front profile later.
- Position the Tool-holder with the countersunk holes facing up.
- Insert each Thimble into the oval hole in part Tool-holder.
- Insert a **large spring** (0.5 x 8.5 x 30 x 15) into each Thimble.
- Insert **two small springs** (0.63 x 5 x 15 x 11) into the side holes of part Tool-holder.
- Repeat the same procedure for all remaining Tool-holder parts.

## KROK 69 Installing the tool holders

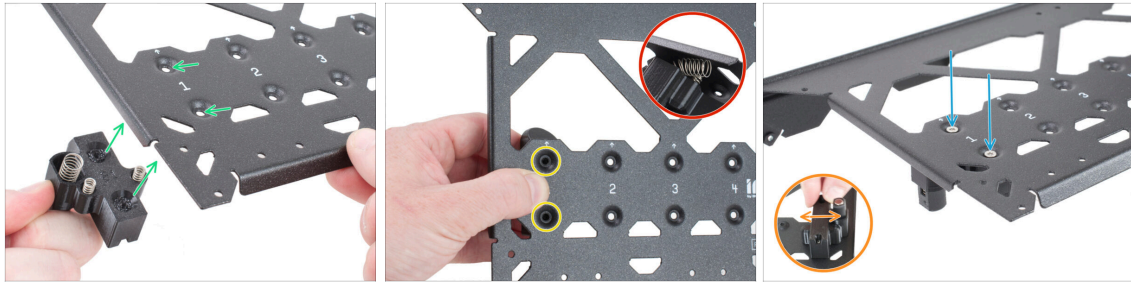

- ◆ **In the correct orientation**, place the Tool-holder against **position 1** on the underside of the front profile.
- ◆ Zrównaj ze sobą otwory w obydwóch częściach.
- ⚠ **CAUTION:** When placing the Tool-holder, make sure **no spring is pinched** against the front profile.
- ◆ Secure the Tool-holder using two M3x12cT screws.
- i The screw forms its own thread in the plastic. Slight resistance is expected.
- ◆ Grasp the Tool-holder and gently wiggle it. It **must not be rigid** - a slight, barely perceptible looseness is required.
- ✂ **Repeat the procedure for the remaining Tool-holder assemblies** on the front profile, ideally in order 1-4, then 8-5 for easier handling.

## KROK 70 Nozzle seal holder: parts preparation



- ◆ **Do kolejnych etapów przygotuj:**
- ◆ Nozzle-seal-holder (4x) *found in the Tools bag*
- ◆ Nozzle parking plate (8x) *found in the Fasteners Tools INDX*
- ◆ Nozzle seal (8x) *found in the Fasteners Tools INDX*
- ◆ M3x8rT screw (16x) *found in the Fasteners 2/2 bag*

## KROK 71 Assembling the nozzle seal

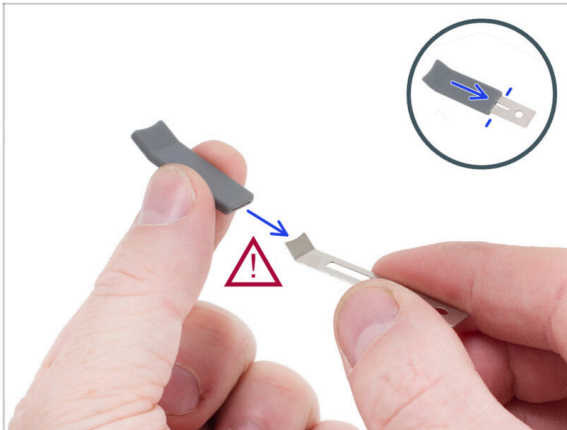

- Slide a nozzle seal (silicone sleeve) onto each nozzle parking plate.

⚠ **CAUTION:** Handle with care! The edges of the nozzle parking plate are **sharp** and may cause injury.

## KROK 72 Assembling the Nozzle-seal-holder



⚠ Note the **correct placement** of the nozzle seal before attaching it to the Nozzle-seal-holder.

- In the correct position, the nozzle seal on the opposite side **must not extend** beyond the Nozzle-seal-holder.
- Place the nozzle seal assembly onto the Nozzle-seal-holder so that the bent part of the Nozzle seal **faces upward**.
- Attach the nozzle seal assembly to the Nozzle-seal-holder using an M3x8rT screw.
- Install two nozzle seals on each Nozzle-seal-holder using the same method.
- Repeat the same procedure for the remaining assemblies.

## KROK 73 Installing the nozzle parking plates

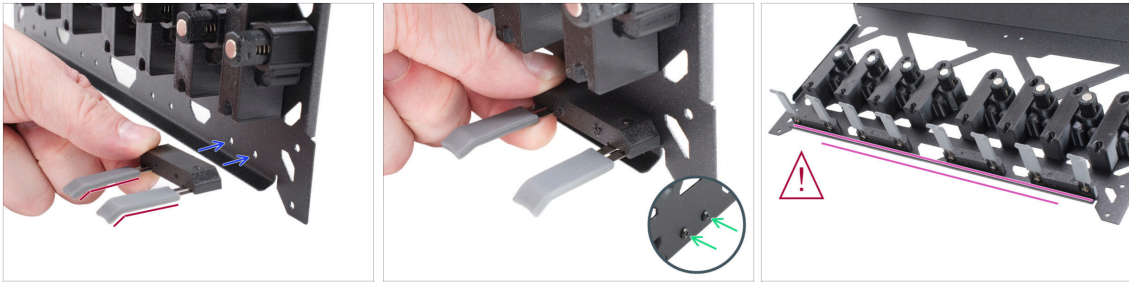

- ◆ Align the nozzle holder assembly with the holes at positions 1–2 on the front profile.
  - ◆ Ensure the nozzle seals are **correctly oriented** by matching the bent ends to the illustration.
  - ◆ From the front, secure the nozzle seal holder assembly with two M3x8rT screws and tighten firmly.
  - ⓘ The screw forms its own thread in the plastic. Slight resistance is expected.
- ⚠ **Ensure that no nozzle parking plates are bent during the assembly.**
- ◆ Continue installing the remaining nozzle holder assemblies using the same method.

## KROK 74 Ventilation lever: parts preparation



- ◆ **Do kolejnych etapów przygotuj:**
- ◆ INDX-C1-Vent-lever (1x)
  - ◆ INDX-C1-Vent-lever-holder (1x)
  - ◆ M3 washer (1x)
  - ◆ M3x8rT screw (3x)

## KROK 75 Assembling the ventilation lever



- Place the Vent-idler onto the Vent-idler-holder **in the same orientation**.
- Secure it with an M3x8rT screw.
  - **Place an M3 washer under the screw.**
- From the inner side of the front profile, align the part with the two holes.
  - Note the “TOP” marking on the Vent-lever-holder. It **must face upward toward** the bent section of the front profile.
- From the opposite side (front) secure it with two M3x8rT screws.

## KROK 76 Top cover: parts preparation I.



- Do kolejnych etapów przygotuj:
  - INDX-C1-grill-flexi (2x) *found in the Top Cover Parts bag*
  - INDX-C1-cover-latch (2x) *found in the Top Cover Parts bag*
  - INDX-C1-cover-knob (2x) *found in the Top Cover Parts bag*
  - M3x12cT screw (2x) *found in the Fasteners 2/2 bag*
  - M3x8rT screw (2x) *found in the Fasteners 2/2 bag*
  - M3x8 screw (2x) *found in the Fasteners 1/2 bag*

## KROK 77 Top cover: parts preparation II.

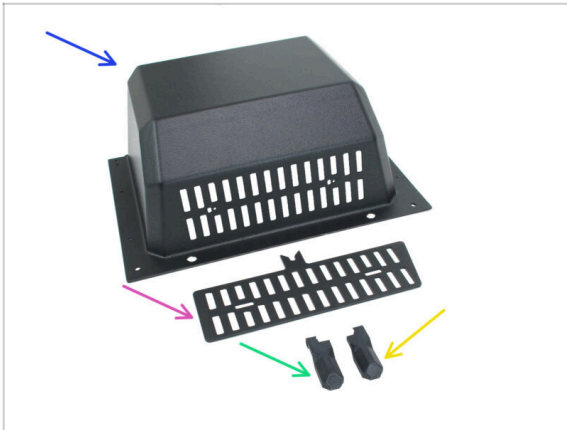

- Do kolejnych etapów przygotuj:
- Top cover (1x) found in the main box
- Grille (1x) found in the main box
- INDX-C1-hinge-cover-left (1x) found in the Top Cover Parts bag
- INDX-C1-hinge-cover-right (1x) found in the Top Cover Parts bag

## KROK 78 Attaching the hinge covers



- Turn the top cover upside down and attach the Hinge-cover from the bottom.
- Secure each Hinge-top with two M3x12cT screws.
- Make sure that you do not overtighten the screws.**

## KROK 79 Attaching the grill



- ◆ Place the grill onto the top cover.
- ◆ Note the correct position of the grill. Ensure that it looks exactly as shown in the photo.
- ◆ Insert the INDX-C1-grill-clamps and hold them in position.
- ◆ Secure the grill in place with two M3x8T screws.

## KROK 80 Attaching the left cover lock



- ◆ Insert the INDX-C1-cover-latch into the top cover from the bottom. Note the orientation of the cover latch.
- ◆ Attach the INDX-C1-cover-knob. Ensure that the knobs on the cover latch align with the holes in the cover knob. Press both parts together.
- ◆ Secure the cover lock in place with the M3x8 screw.



Do not overtighten the screw. The lock must be able to turn.

## KROK 81 Attaching the right cover lock



- ◆ Insert the INDX-C1-cover-latch into the top cover from the bottom. Note the orientation of the cover latch.
- ◆ Insert the INDX-C1-cover-latch into the top cover from the bottom. Note the orientation of the cover latch.
- ◆ Secure the cover lock in place with the M3x8 screw.
-  Do not overtighten the screw. The lock must be able to turn.

## KROK 82 Top cover back: parts preparation



- ◆ Do kolejnych etapów przygotuj:
  - ◆ Top cover back (1x) *found in the main box*
  - ◆ Hinge-base (2x) *found in the ..... bag*
  - ◆ M3x12sT screw (2x) *found in the Fasteners 2/2 bag*
  - ◆ M3x25 screw (2x) *found in the Fasteners 1/2 bag*
  - ◆ Nylon rivet (2x) *found in the Fasteners 1/2 bag*
  - ◆ Spring 0,63x5x15x11 (2x) *found in the Fasteners Tools bag*

### KROK 83 Attaching the top cover back



- Place the top cover back on the printer.
- Secure the top cover back in place with two nylon rivets.

### KROK 84 Attaching the hinge base - left



- Place the Hinge-base near the front left hole in the top cover back.
- Note that each Hinge-base part indicates which side it goes to. Ensure that the part is marked with an L (left).
- Insert the M3x8rT screw from inside the printer and hold it in position.
- Align the hole in the Hinge-base with the M3x12sT screw and connect the Hinge-base to the printer.
- Tighten the M3x12sT screw while holding the Hinge-base in place.

## KROK 85 Attaching the hinge base - right

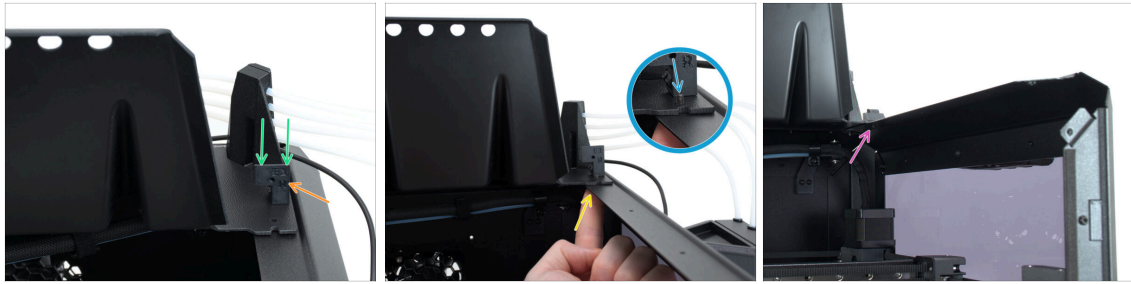

- Place the Hinge-base near the front left hole in the top cover back.
- Note that each Hinge-base part indicates which side it goes to. Ensure that the part is marked with an L (left).
- Insert the M3x8rT screw from inside the printer and hold it in position.
- Align the hole in the Hinge-base with the M3x12sT screw and connect the Hinge-base to the printer.
- Tighten the M3x8rT screw while holding the Hinge-base in place.

## KROK 86 Attaching the top cover I.

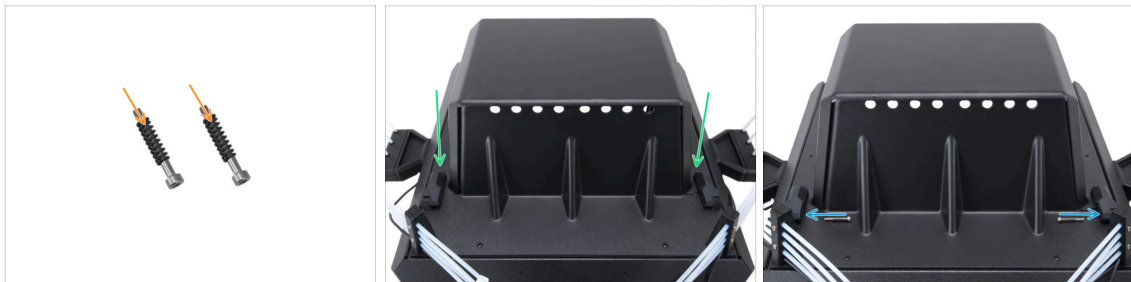

- Attach the Spring 0,63x5x15x11 on each of the M3x25 screws.
- Place the top cover on the printer. Make sure that both hinges are positioned correctly.
- Insert one Mx25 screw with the spring into each hinge from the inner side.

## KROK 87 Attaching the top cover II.



- Use an Allen key to tighten the M3x25 screw on the left hinge. Do not tighten it completely.
- Use an Allen key to tighten the M3x25 screw on the right hinge. Do not tighten it completely.
- Slowly open the top cover all the way.
- Make sure that the spring is able to retract and expand when opening the lid. This will hold the top cover open.
- ⓘ If the top cover does not stay open, check the tightness of the two M3x25 screws in the hinges and make sure the spring is in place.

## KROK 88 INDX Nozzle tool: parts preparation



- Do kolejnych etapów przygotuj:
  - M3x4 screw (2x) that were removed earlier
  - Nylon rivets (2x) found in the Fasteners 1/2 bag
  - M3x4rT screw (2x) that were removed earlier
  - INDX CHT Nozzle tool (8x)
- ⚠ **Warning: Avoid touching or damaging the rectangular sensing area on the INDX CHT Nozzle tool. Fingerprints, grease, or any damage can affect temperature readings and cause print issues.**

## KROK 89 Attaching the tooldock

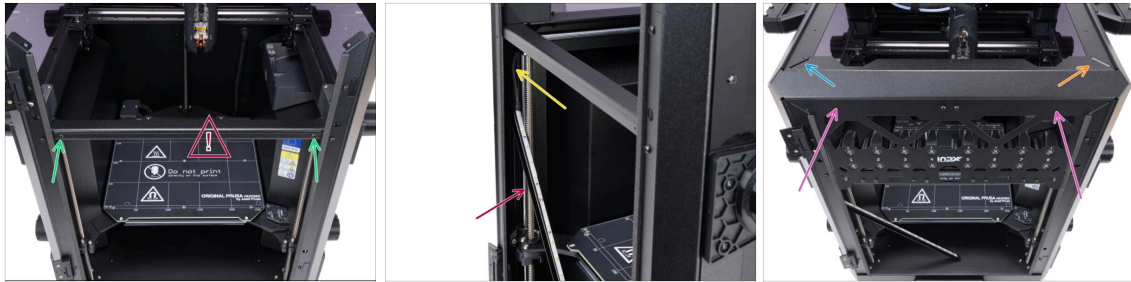

- ◆ Remove the two M3x4rT screws that hold the LED panel in place. Set the screws aside, we will need them very soon.
- ⚠ Support the LED panel with your hand when removing the screws, so it does not fall. **Do not touch the LEDs and resistors on the LED strip!**
- ◆ Gently lean the LED panel on the left side of the printer.
- ◆ Make sure that the LED cable is not damaged or pulled too hard during these steps.
- ◆ Mount the assembled tooldock.
- ◆ The left side of the tooldock has to go under the top profile.
- ◆ The right side of the tooldock has to go over the top profile.

## KROK 90 Securing the tooldock

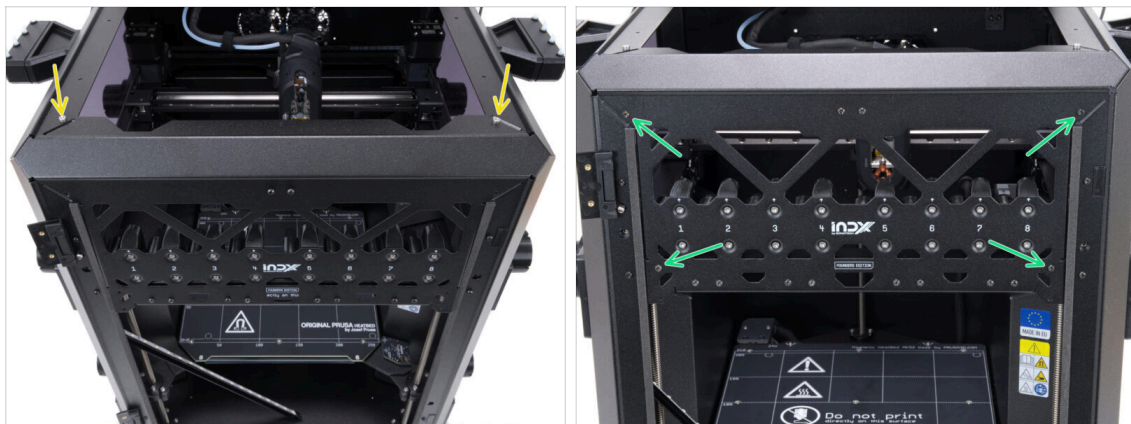

- ◆ Secure the tooldock to the top profiles with one M3x4 screw on each side.
- ◆ Secure the tooldock to the front of the printer with four M3x4rT screws.

## KROK 91 Montaż panelu LED



- ◆ Mount the LED panel onto the tool dock. Do not touch LEDs and resistors on the LED strip!
- ⓘ The LED cable should reach the new position of the LED panel. If the cable is too short, **gently and slowly** pull on it to make it the correct length.
- ◆ Use two nylon rivets to secure the LED panel in place.
- ◆ Close the top cover.

## KROK 92 Optional: Installing the Buddy3D Camera



- ⓘ This step is only required if you have a Buddy3D Camera.
- ◆ Now is the right time to mount the camera in the front-left corner of the printer.
- ◆ Use the dedicated installation guide: Buddy3D Camera for CORE One Installation
- ⓘ The guide shows installation on the CORE One, but the procedure is the same. The camera attaches magnetically to the upper profiles of the printer.

## KROK 93 Connecting the INDX Nozzle tools (positions 1-4)



- Close the top lid.
- Insert the PTFE tubes through the openings on the back of the lid, **keeping the correct order**.
  - Insert the PTFE tube from position 1 into the first opening from the right.
  - Repeat the same process for the remaining positions. **Always make sure each PTFE tube is routed through the matching opening in the lid.**
- Open the lid and, from the inside, fully insert the **PTFE tube from the first opening** into the INDX CHT Nozzle Tool at **position 1**.
  - Gently pull the tube to verify it is locked in the collet.
- Repeat the same procedure for all tools in positions 1-4.

## KROK 94 Docking the tools (positions 1-4)

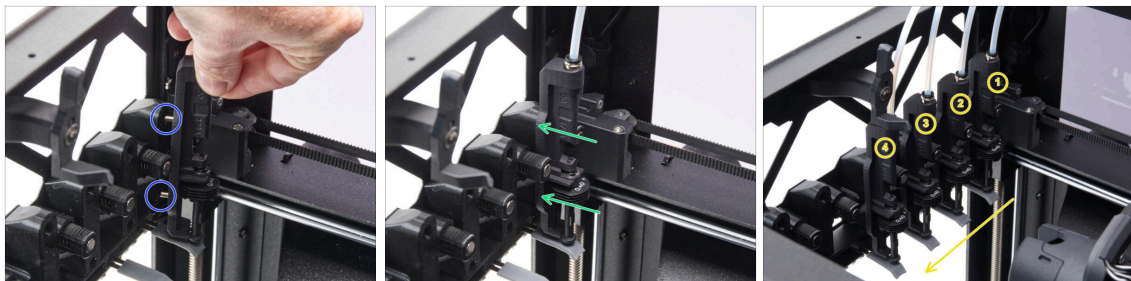

- Place the INDX CHT Nozzle tool **on the first PTFE tube** onto tool dock **position 1** and align the magnetic pins on the tool with the openings in the tool dock.
- Snap the INDX CHT Nozzle tool it into tool dock **position 1**.
  - ⚠ **Make sure both pins snap in fully and the tool sits perfectly flush.**
- Repeat the same procedure for the remaining tools up to position 4.
- ⓘ Double-check that the **nozzle parking plates are in the correct position** to seal the INDX CHT Nozzle tool.

## KROK 95 Connecting the INDX Nozzle tools (positions 5-8)



- ◆ Close the top lid.
- ◆ Insert the PTFE tubes through the openings on the back of the lid, **keeping the correct order**.
  - ◆ Insert the PTFE tube from **position 8** into the **first opening from the left**.
  - ◆ Repeat the same process for the remaining positions. **Always make sure each PTFE tube is routed through the matching opening in the lid.**
- ◆ Open the lid and, from the inside insert the **PTFE tube from the rightmost opening** into the INDX CHT Nozzle Tool at **position 8**.
  - ◆ Gently pull the tube to verify it is locked in the collet lines.
- ◆ Repeat the same procedure for all tools in positions 8-5.

## KROK 96 Docking the tools (positions 5-8)

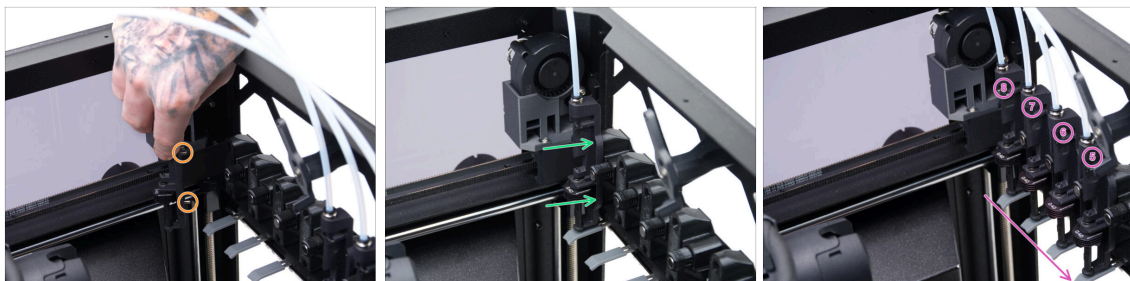

- ◆ Place the INDX CHT Nozzle tool **on the last PTFE tube** onto tool dock **position 8** and align the magnetic pins on the tool with the openings in the tool dock.
- ◆ Snap the INDX CHT Nozzle tool it into tool dock **position 8**.
  - ⚠ **Make sure both pins snap in fully and the tool sits perfectly flush.**
- ◆ Repeat the same procedure for the remaining tools up to position 5.
- i Double-check that the **nozzle parking plates are in the correct position** to seal the INDX CHT Nozzle tool.

## KROK 97 Checking the tubes



- ⚠ Check that the PTFE tubes are not swapped and that each tube is correctly routed to the corresponding tool position.
- 🟢 You can now close the lid and secure it by rotating the locks by 90°.
- 📘 **This is optional at this stage**, as the lid will need to be opened again later during calibration.
- 🔵 Remove the empty cardboard box from the printer, as it will no longer be needed.

## KROK 98 Offset sensor cover: parts preparation

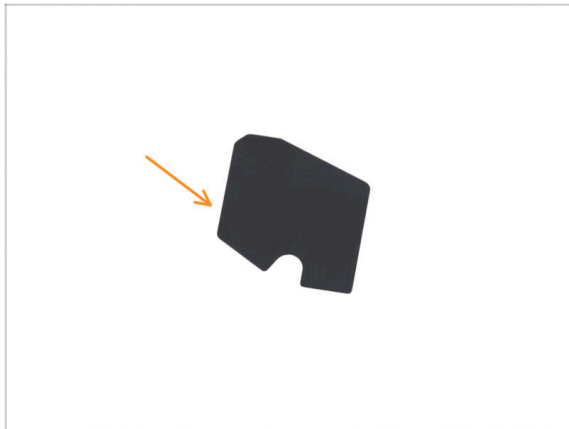

- ⬛ Do kolejnych etapów przygotuj:
- 🟠 Offset sensor sticker (1x) *found in the Tool Dock Fan bag*
- 📘 The color of the offset sensor sticker might differ, but it does not affect the functionality.

## KROK 99 Covering the offset sensor

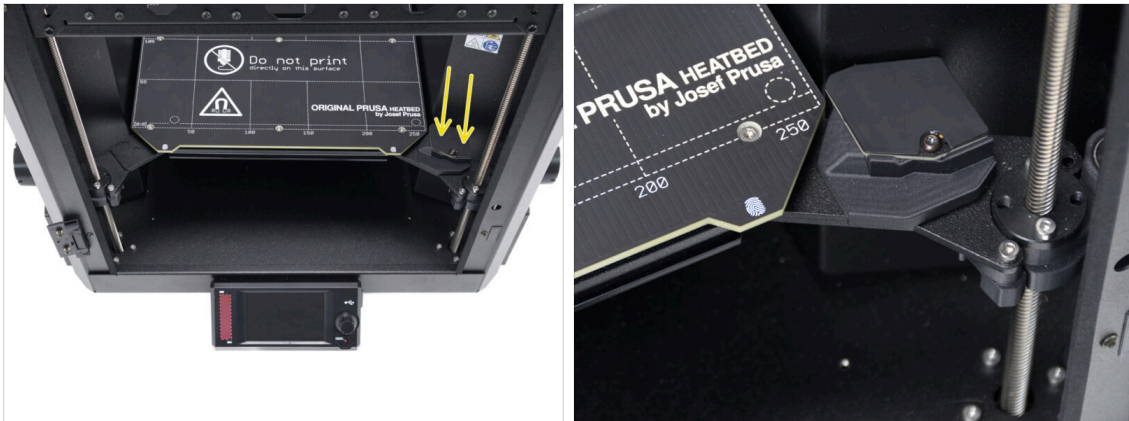

- Peel the protective layer off the offset sensor sticker and gently place the sticker onto the FunFan board.
- Ensure that the sticker covers the whole board.

## KROK 100 Panel drzwi: przygotowanie części



- **Do kolejnych etapów przygotuj:**
- Door panel assembly (1x) *you removed earlier*
- Śruba M3x5rT (4x) *wykręcone wcześniej*
- Top door seal (1x)

## KROK 101 Montaż panelu drzwi

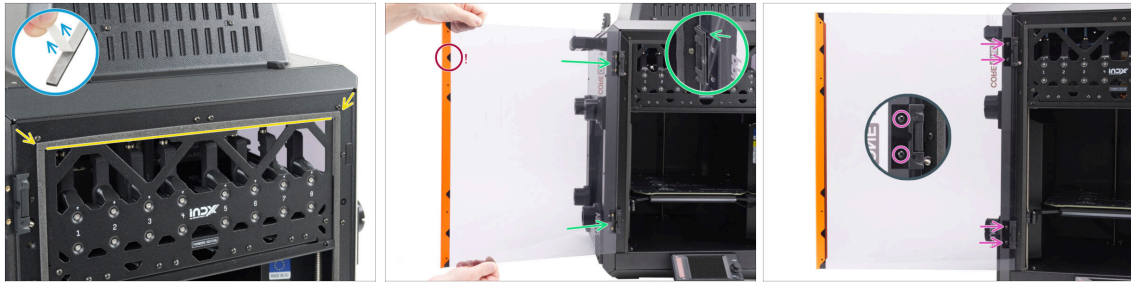

- ◆ Peel away the bottom backing layer of the gasket to expose the adhesive surface.
- ◆ Align the gasket on the front profile with the adhesive side facing the surface, then press it down to adhere.
- 📌 If you had any issues with the shaft falling out of the hinge, assemble the hinge now, before mounting the door panel.
- ◆ Wsuń panel drzwi do końca na zawiasy.
- ⚠️ **Ensure the door panel is oriented correctly, with the handle facing outward. Use the V-shaped cutouts on the inner side of the door handle as a guide.**
- ◆ Umieść dwie śruby M3x5rT w każdym zawiasie, które posłużą do zamocowania panelu.
- ◆ **Secure the screws gently** to avoid over-tightening or damaging the door panel.

## KROK 102 Haribo time !

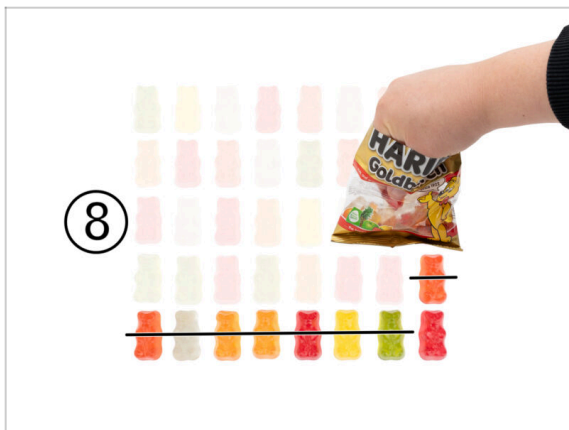

- ◆ You're almost there. Take a break and get ready for the final chapter.
- ◆ Zjedz osiem żelków.
- ⓘ Now you have only one gummy bear left. Maybe more, depending on the factory filling. But we have one more reward coming, so keep the rest aside!

## KROK 103 That's it



- ◆ **Congratulations!** You have successfully upgraded to the INDX Founders Edition.
- ⓘ Next, you only need to run the self-test and basic calibration.
- ◆ **Proceed to the next chapter.**

## 6. Kontrola przed uruchomieniem

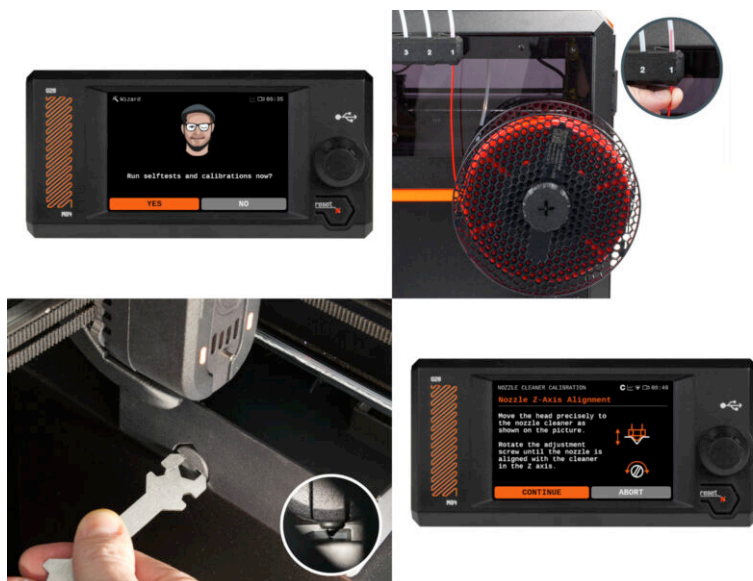

## KROK 1 Montaż uchwyty szpuli: przygotowanie części

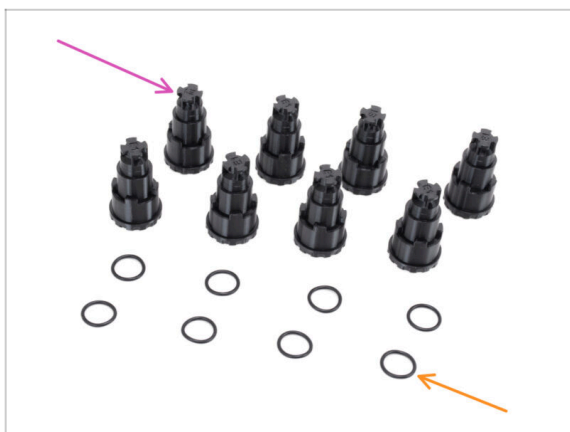

- Do kolejnego etapu przygotuj:
  - Spoolholder-static (8x)
  - O-ring (8x)
- i** Element stały uchwyty szpuli [Spoolholder-static] i o-ring znajdują się w tym samym woreczku.

## KROK 2 Locking the spool holders



- Założ o-ring na element stały uchwyty.
- Push the Spoolholder-static into the Puck-universal dock.
- Lock the Spoolholder-static it in by turning it **clockwise**.
-  Repeat the same procedure for the remaining spool holders.

### KROK 3 Położenie arkusza na stole



- ⚠ **Upewnij się, że nic nie znajduje się na stole grzewczym.** Stół musi być czysty. Wszelkie zabrudzenia mogą uszkodzić powierzchnię zarówno stołu grzewczego, jak i arkusza druku.
- 🟡 **Aby położyć płytę na stole grzewczym, najpierw wyrównaj tylne wycięcie z kołkami ustalającymi w jego tylnej części.** Trzymaj płytę za dwa przednie rogi i powoli połóż na stole grzewczym - uważaj na palce!
  - ⬛ Utrzymuj arkusz druku w czystości, aby uzyskać optymalną wydajność.
  - ⬛ Przyczyną nr 1 odklejania się wydruków od arkusza jest zatłuszczona powierzchnia. Użyj IPA (alkoholu izopropylowego), aby ją odtłuścić, jeśli wcześniej zdarzyło Ci się dotknąć powierzchni.

### KROK 4 Firmware update



- ⬛ Odwiedź stronę [help.prusa3d.com](http://help.prusa3d.com)
- 🔵 Navigate to the CORE One INDX page.
- 🟢 Pobierz najnowszą wersję firmware.
- ⬛ Zapisz plik z firmware (.bbf) w pamięci USB.

## KROK 5 Włączenie drukarki



- ◆ Podłącz do drukarki pamięć USB z zestawu.
  - ⓘ Dołączona pamięć USB zawiera plik z najnowszym firmware.
- ◆ Podłącz przewód zasilający do zasilacza, następnie do gniazdka sieciowego.
- ◆ Włącz drukarkę za pomocą przełącznika znajdującego się z tyłu.
- ⓘ Drukarka automatycznie sprawdzi czy w pamięci USB znajduje się nowa wersja firmware.
- ◆ Jeśli pojawi się ekran "New firmware available" [Dostępna jest nowa wersja firmware], naciśnij **FLASH** przy pomocy pokrętki, aby zaktualizować oprogramowanie do najnowszej wersji.

## KROK 6 Konfiguracja drukarki: Intro

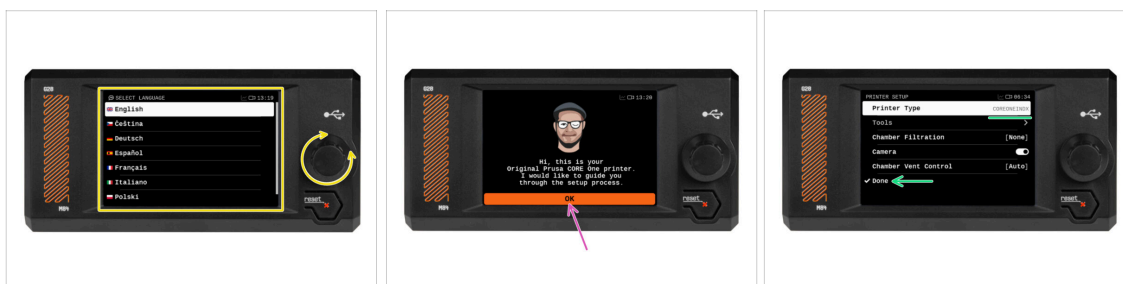

- ◆ Drukarka wyświetli na ekranie monit o wybranie języka. Użyj pokrętki lub ekranu dotykowego, aby ustawić preferowany język.
- ◆ Po wybraniu języka drukarka wyświetli ekran powitalny. Naciśnij **OK**, aby kontynuować proces konfiguracji.
- ◆ The next screen will prompt you to select your printer model COREONEINDX. Hit **Done** to continue.

## KROK 7 Konfiguracja drukarki: Połączenie sieciowe



- Na ekranie konfiguracji sieci pojawi się prośba o połączenie z siecią Wi-Fi z użyciem oficjalnej aplikacji mobilnej Prusa.
  - i Więcej o aplikacji przeczytasz tutaj: [prusa.io/app](https://prusa.io/app).
- Jeśli wybierzesz **Nie**, drukarka wyświetli alternatywne sposoby połączenia z siecią Wi-Fi. Ten krok jest opcjonalny i możesz to zrobić później.
  - i Możesz pominąć ten etap i skonfigurować połączenie sieciowe później.

## KROK 8 Wizard: Intro

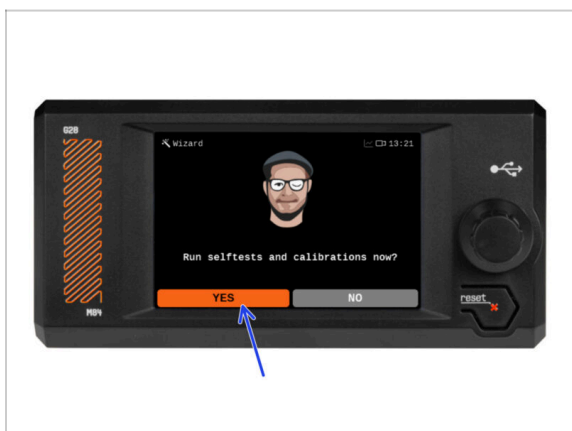

- i Drukarka wyświetli monit o przeprowadzenie Selftestu i kalibracji wszystkich ważnych komponentów. Cały proces trwa kilka minut, a niektóre jego etapy wymagają Twojej interakcji.
  - Naciśnij **Tak**, aby rozpocząć Selftest i postępuj zgodnie z instrukcjami wyświetlanymi na ekranie.
  - ⚠ **Podczas Selftestu drzwi powinny być zamknięte do momentu wyświetlenia monitu. Otwarcie ich spowoduje przerwanie procesu.**
  - **Podczas Selftestu wewnątrz drukarki poruszają się GORĄCE części.**
  - i Some of the automatic tests that do not require direct input from the user are not mentioned in this guide.

## KROK 9 Wizard: Door sensor calibration



- i **This step can be skipped.** The door sensor is only calibrated during assembly and has a dedicated calibration section at the end of its own guide.
- ◆ Hit the **Skip** button to proceed to the next calibration.
- ◆ Follow the instructions on the screen. The printer will now run the automatic X-axis and Y-axis test, and the Z alignment calibration.

## KROK 10 Wizard: Belt tensioning

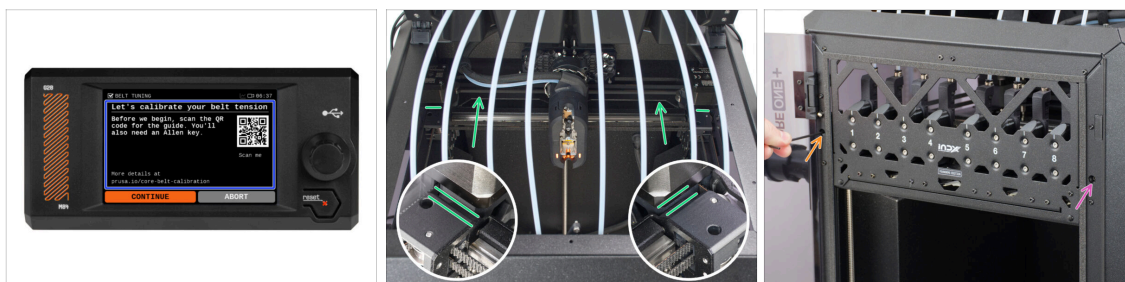

- ◆ The printer will now prompt you to fine-tune the belts. Follow the on-screen instructions.
- ◆ Open the top lid and manually move the INDX Tool head **as far back as possible** and check that there are **no gaps between the stops** on the left and right.
- ⚠ **UWAGA: nieprawidłowe wykonanie tej procedury może spowodować uszkodzenie elementów plastikowych lub zablokowanie śrub. Przed regulacją naprężenia paska przeczytaj odpowiedni artykuł:**
  - ◆ Adjusting **belt tension (CORE One)**
  - ◆ The belts are adjusted using the tensioning mechanism on each side for each belt:
    - ◆ The **left screw** adjusts the **upper belt**.
    - ◆ The **right screw** adjusts the **lower belt**.
  - ◆ Once the belts are perfectly tuned, press **Continue** and follow the on-screen instructions.

## KROK 11 Wizard: Dock calibration (part 1)



- ◆ Once the automatic homing calibration is complete, calibrate the docks. Hit **Continue** and follow the on-screen instructions.
- ◆ The printer will ask you to enter the number of docks on your printer.
  - ◆ It means how many tool dock positions are installed on the front profile (nozzle holders). This is typically 4 or 8.
- ◆ On the next screen, ensure that all dock positions are **set to** and not to .
- ◆ Once all docks are ready to be calibrated, scroll down and hit **Continue**.

## KROK 12 Wizard: Dock calibration (part 2)

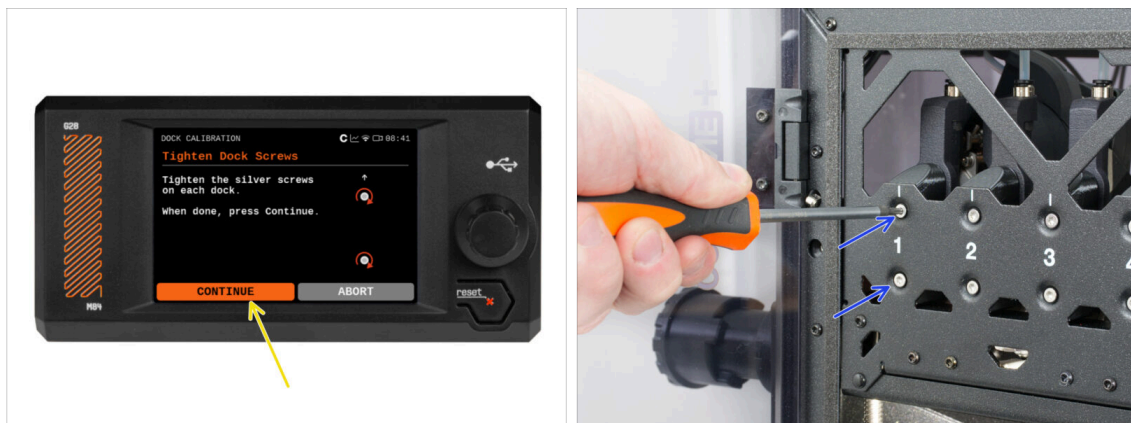

- ◆ The screen will now prompt you to tighten the silver screws securing each dock to the front profile.
  - ◆ Use a T10 key/screwdriver to tighten the silver screws **in all positions**.
  - ◆ **Do not overtighten them**, as they will be loosened again later.
  - ◆ Hit **Continue**.
- ⓘ Make sure to **follow the on-screen guide in the next step**. The printer will inform you when it is safe to touch it and calibrate the docks.

## KROK 13 Wizard: Dock calibration (part 3)



Keep the top lid open.

- You are not prompted to manually move the head onto the dock.
- From above, carefully slide the INDX Tool head onto tool dock **position 1** by hand.
  - Watch the alignment from above to ensure the **head seats perfectly onto the hotend**.
  - Once properly seated, you will feel a click indicating the correct position.
- Hit **Continue** and repeat the same process for the remaining docks, **following the on-screen instructions**.
- After all docks have been aligned, loosen the silver screws securing all dock positions by one full turn.

## KROK 14 Wizard: Loadcell Test



- ◆ W kolejnym kroku kreatora pojawi się monit o dotknięcie dyszy w celu przetestowania i skalibrowania czujnika tensometrycznego. Podczas tej procedury **części drukarki nie są podgrzewane**, więc możesz ich bez obaw dotykać. Kliknij przycisk **Kontynuuj**.
- ⓘ Kalibracja czujnika tensometrycznego wymaga otwarcia drzwiczek, ponieważ konieczna jest czynność wewnątrz drukarki.
- Nie dotykaj jeszcze dyszy, poczekaj aż zostanie wyświetlony komunikat: **Dotknij dyszę TERAZ**.
- ◆ Dotknij dyszy z dołu. Jeśli czujnik tensometryczny nie wykryje wystarczająco silnego dotyku, zostanie wyświetlony monit o powtórzenie tego etapu. Jeśli natomiast test się powiedzie, zobaczysz **Test tensometru OK**.
- ◆ **Zamknij drzwiczki**, aby pozwolić drukarce na kontynuowanie pracy.
- 🔒 After this test, the printer will run the automatic Z-axis test.

## KROK 15 Wizard: Fan test



- The printer will test all the fans during this process. Be aware—it can get quite noisy for a while!

## KROK 16 Wizard: Tool offsets calibration



- Select **Continue**, and the printer will proceed with testing the offsets for each toolhead.

## KROK 17 Wizard: Nozzle cleaner calibration



- In the following steps, you will calibrate the nozzle with the wiper bin.
- Once you press **Continue**, the Toolhead will move itself closer to the priming block on the nozzle cleaner.
- In the tooldock, **under position 8, there is an opening** through which you can directly observe nozzle alignment on the silicone priming block.
  - ⓘ If you look closely through the opening, you will see the V-shaped cutouts in the wiper base and the silicone priming block.
- Manually move the head above the bin on the right side of the printer. Position it in the middle of the priming block as shown on the screen.
- Through the opening, observe and align the head with the V-shaped cutout in the front priming block, as shown on the screen.

## KROK 18 Wizard: Nozzle cleaner calibration Z/X-axis

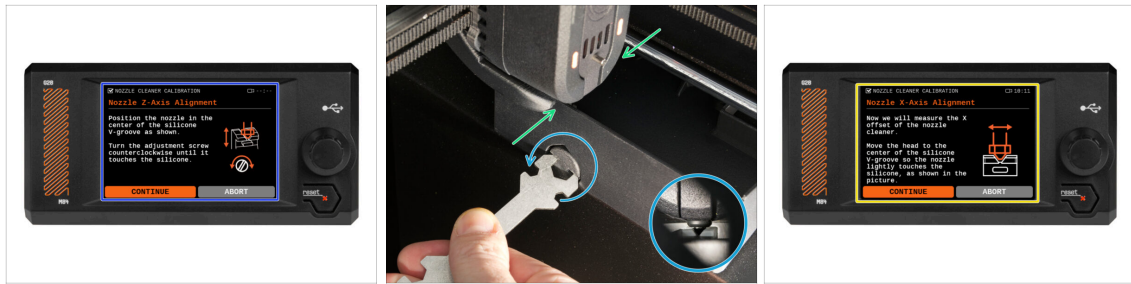

- The printer will now prompt you to align the nozzle cleaner.
- Manually adjust the head position so the nozzle is placed in the **V-shaped cutout in the silicone priming block**. Observe the alignment through the front opening in the tooldock.
- Use the universal wrench to **precisely adjust** the Wiper-adjuster until the nozzle **fully fills the V-shaped cutout**, touching both angled sides and the bottom. Check the alignment through the opening.
- ⓘ The Wiper-adjuster allows the bin position to be adjusted up or down.
- Once the position is correctly set (see reference detail), select **Continue** and follow the on-screen instructions.
- The printer will lock the motors and warn you to **remove your hands from the printer** before proceeding with the calibration.

## KROK 19 Wizard: Nozzle cleaner calibration Y-axis



- Now, the printer screen prompts you to align the nozzle on the Y-axis.
- Manually move the INDX Tool head into the V-shaped cutout on the left side of the nozzle cleaner bin and **precisely align it**. The nozzle must not touch the walls.
- The correct cutout is marked with "Y"
  - Observe through the open door.
  - Once the alignment is perfect, press **Continue** and follow the on-screen instructions.
  - The printer will lock the motors and warn you to **remove your hands from the printer** before proceeding with the calibration.

## KROK 20 Wizard: Filament sensors calibration

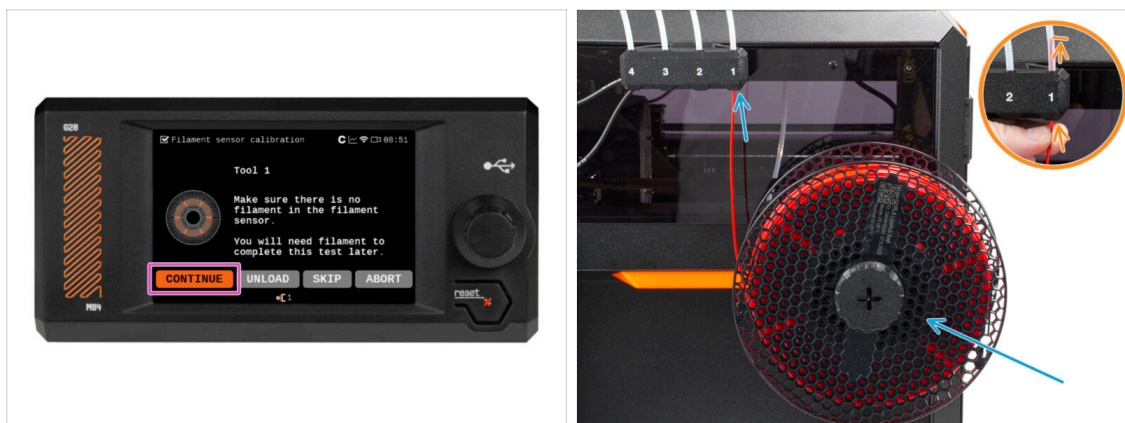

- ◆ During each tool filament sensor calibration, you will need a short piece of filament. Prepare the filament and select **Continue**.
- ❗ There should be **no filament** inside the extruder before the calibration process starts.
- Place the filament spool on the spoolholder and, **when prompted**, guide the filament into the filament sensor at **position 1**.
  - Insert the filament **only through the filament sensor**; there is no need to feed it through the full length of the PTFE tube.
- After calibration finishes press **Continue** to calibrate the next position.
- 📌 Once all the positions are calibrated, continue to the automatic calibrations of phase stepping and input shaper.

## KROK 21 Wizard complete



- Congratulations! The Wizard is complete. Now let's test some prints.

## KROK 22 Haribo time!



- ◆ All your hard work has paid off, and it's time for the final reward. Finish all the gummy bears now.

## KROK 23 Prusa knowledge base

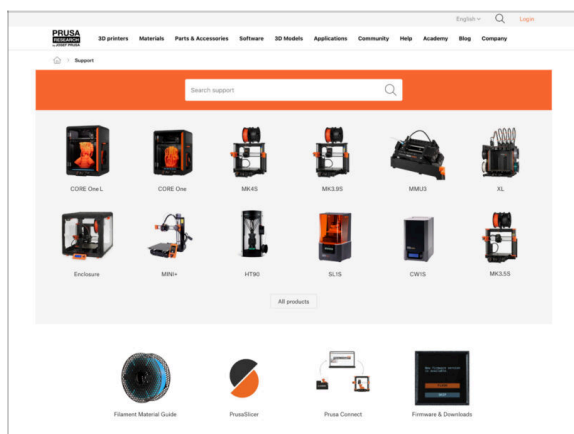

- ◆ Go to the **CORE One/+ INDX** product page at [prusa.io/coreone-indx](https://prusa.io/coreone-indx) and navigate to the **Getting started** section for additional information and resources.
- ◆ You can also find more information at [help.prusa3d.com](https://help.prusa3d.com):
  - 📌 Znajdziesz tam oprogramowanie do pobrania, instrukcje obsługi i szczegółowe instrukcje montażu.
  - 📌 Dostaniesz dostęp do porad dotyczących rozwiązywania problemów i odpowiedzi na często zadawane pytania.
  - 📌 Tutorials and articles to help you get the most out of your printer.
- 📘 Codziennie dodajemy nowe tematy!

## KROK 24 Give us feedback

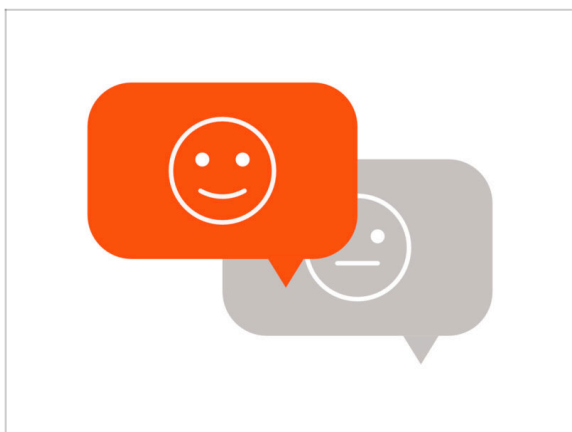

- Wiemy, że nie możesz się doczekać rozpoczęcia drukowania, ale będziemy wdzięczni, jeśli poświęcisz 3-4 minuty na **podzielenie się swoimi przemyśleniami** na temat tej instrukcji: jak zroszciała była, jak łatwo było ją wykonywać i jakie masz pomysły na jej ulepszenie.

**i** Ta opinia różni się nieco od zwykłych komentarzy, które możesz zostawić w poszczególnych krokach.

- Podziel się opinią tutaj.**
- Dziękujemy za pomoc w ulepszaniu naszych instrukcji!

## KROK 25 Join Printables!

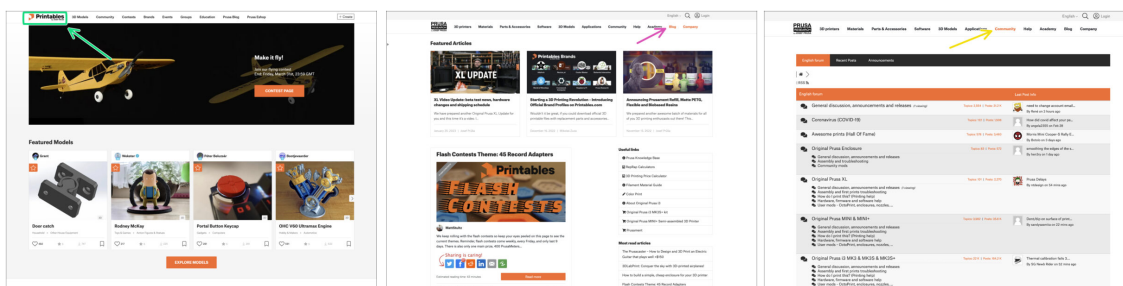

- Nie zapomnij dołączyć do największej społeczności użytkowników urządzeń marki Prusa! Znajdziesz tam najnowsze modele w formie plików STL i gotowe pliki G-code dla Twojej drukarki. Zarejestruj się na Printables.com
- Szukasz inspiracji dla nowego projektu? Przejrzyj nasz blog i cotygodniowe aktualizacje.
- Jeśli potrzebujesz pomocy przy montażu, sprawdź nasze forum, prowadzone przez rewelacyjną społeczność :-)
- i** Do wszystkich usług firmy Prusa wystarczy jedno konto.















